

Welcome to the world of Mercedes-Benz

Before you first drive off, read this Operator's Manual carefully and familiarize yourself with your vehicle. For your own safety and a longer operating lifespan, follow the instructions and warning notices in this Operator's Manual. Disregarding them may result in damage to the vehicle or environment or in injuries to people.

Vehicle damage caused by failure to observe the instructions is not covered by the New Vehicle Limited Warranty.

The standard equipment and product description of your vehicle may vary, depending on the following factors:

- Model
- Order
- National version
- Availability

Mercedes-Benz reserves the right to introduce changes in:

- Design
- Equipment
- Technical features

Your vehicle may therefore differ, in individual cases, from that shown in the descriptions and illustrations.

The following documents are integral parts of the vehicle:

- Digital Operator's Manual
- Printed Operator's Manual
- Service booklet
- Equipment-dependent supplements

Always keep these documents in the vehicle. If you sell the vehicle, always pass all documents on to the new owner.

Mercedes-Benz Vans, LLC

Mercedes-Benz Canada, Inc.

A Mercedes-Benz Group AG Company

9075842215



Symbols 4

At a glance 6

Cockpit	6
Instrument cluster	8
Overhead control panel	11
Door operating unit	16
Emergencies and breakdowns	18

Digital Operator's Manual 20

Calling up the Digital Operator's Manual	20
--	----

General notes 21

Environmental protection	21
Mercedes-Benz Genuine Parts	21
Attachments, add-on equipment, installations and conversions	22
Operator's Manual	23
Service and vehicle operation	23
Operating safety	24
Declarations of conformity and notes on driving in different countries	25
Diagnostics connection	25
Notes on changes to the engine output	26
Qualified specialist workshop	26
Vehicle registration	27
Correct use of the vehicle	27
Multi-purpose vehicle	27
Notes for persons with electronic medical aids	28
Problems with your vehicle	28
"Reporting safety defects"	28
Limited Warranty	29
QR codes for rescue card	29
Data storage	29
Copyright	32

Occupant safety 33

Brief overview of most important points	33
Information on the automatic functions of the restraint system	36
Purpose and function of the restraint system	36
Seat belts	40
Airbags	40

Children in the vehicle 41

Brief overview of most important points	41
Important safety notes	41
Securing the child restraint system	44
Child safety locks	47

Opening and closing 49

SmartKey	49
Doors	51
Sliding door	55
Electric sliding door	55
Rear-end doors	59
Partition sliding door	61
Electrical step	62
Side window	63
Anti-theft prevention	65

Seats and stowage 68

Notes on the correct driver's seat position	68
Notes on grab handles	68
Seats	68
Steering wheel	80
Stowage areas	81
Information about the bottle holder	82
Cup holders	82
Ashtray and cigarette lighter	83
Sockets	83
Wirelessly charging the mobile phone and coupling with the exterior antenna	85
Installing and removing the floor mats	86

Light and vision 87

Lighting	87
Adjusting the interior lighting	90
Changing bulbs	93
Windshield wipers	97
Mirrors	99

Climate control 102

Overview of climate control systems	102
Operating climate control systems	104
Operating air vents	107
Auxiliary heating	108
Operating cargo compartment ventilation	109

Driving and parking 110

Driving	110
Battery main switch	124
Automatic transmission	125
All-wheel drive	127
Electronic level control	128
Refueling	132
Parking	139
Driving and driving safety systems	143
Work mode	169

Trailer operation 170

Instrument cluster and on-board computer 176

Overview of the instrument cluster 176
 Overview of the buttons on the steering wheel 177
 Operating the on-board computer 177
 Overview of the instrument cluster display 178
 Adjusting the instrument lighting 179
 Menus and submenus 179

Mercedes me 184

Mercedes me calls 184
 Mercedes me connect 187
 Mercedes me and apps 188

MBUX multimedia system 190

Overview and operation 190
 System settings 193
 Navigation 196
 Telephone 201
 Overview of Smartphone Integration 204
 Web browser overview 204
 Radio and media 205
 Sound settings 208

Transporting 209

Notes on loading guidelines 209
 Notes on distributing the load within the vehicle 210
 Securing loads 210
 Carrier systems 212
 Placing a load on the wheel arch 212

Maintenance and care 214

ASSYST PLUS service interval display 214
 Engine compartment 214
 Cleaning and care 221

Breakdown assistance 226

Emergency 226
 Emergency Call System 226
 Flat tire 228
 Battery 228
 Towing or tow-starting 231
 Electrical fuses 233
 Vehicle tool kit 235
 Hydraulic jack 236

Wheels and tires 238

Information on noise or unusual driving characteristics 238
 Notes on regularly inspecting wheels and tires 238
 Information on driving with summer tires 238
 Information on M+S tires 239
 Notes on snow chains 239
 Tire pressure 240
 Loading the vehicle 247
 Tire labeling 250
 Information on definitions (tires and loading) 253
 Changing a wheel 255
 Spare wheel 262

Technical data 267

Information on the technical data 267
 On-board electronics 267
 Radio regulations 268
 Vehicle identification plate, vehicle identification number (VIN) and engine number 269
 Operating fluids and capacities 270
 Vehicle data 279
 Trailer hitch 279
 Cargo tie-down points and carrier systems 283

Display messages and warning and indicator lamps 285

Display messages 285
 Indicator and warning lamps 304

Index 315

In these Operating Instructions, you will find the following symbols:

 **WARNING** Danger due to failure to observe the warning notices

Warning notices draw your attention to hazards that may endanger your health or life, or the health or life of others.

 Observe the warning notices.

 **ENVIRONMENTAL NOTE** Environmental damage due to failure to observe environmental notes

Environmental notes include information on environmentally responsible behavior or environmentally responsible disposal.

 Observe environmental notes.

 **NOTE** Damage to property due to failure to observe notes on material damage

Notes on material damage inform you of risks which may lead to your vehicle being damaged.

 Observe notes on material damage.

 These symbols indicate useful instructions or further information that could be helpful to you.

 Instructions

 Further information on a topic page)

Display Messages on the display

 Highest menu level to be selected in the multimedia/audio system

 Corresponding submenus to be selected in the multimedia/audio system

* Indicates a cause

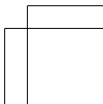
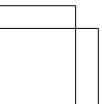
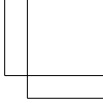
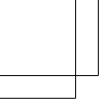

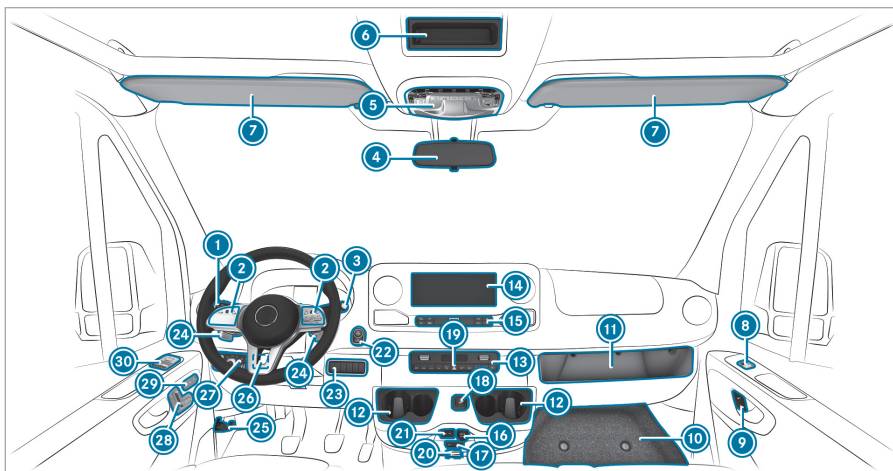

① Combination switch			
Turn signal indicators	→	88	
High beam	→	88	
Windshield wipers	→	97	
Rear window wiper	→	98	
② Steering-wheel buttons	→	177	
③ DIRECT SELECT lever	→	125	
④ Inside rearview mirror	→	101	
Digital inside rearview mirror	→	100	
⑤ Overhead control panel	→	90	
⑥ Device installation frame, e.g. for mounting a tachograph or the timer for the stationary heater			
⑦ Sun visor			
⑧ Front passenger window lifter	→	63	
⑨ Central locking system	→	52	
⑩ Stowage compartment cover	→	235	
⑪ Front passenger storage compartment or tachograph housing			
⑫ Cup holder			
⑬ Climate control system	→	102	
⑭ MBUX multimedia system display			
⑮ MBUX multimedia system control elements			
⑯ 12 V socket	→	83	
⑰ 115 V socket	→	84	
⑱ Opens and closes the electric sliding door	→	56	
⑲ Hazard warning lights	→	88	
⑳ Vehicles with KEYLESS START: key slot	→	112	
㉑ USB port	→	81	
㉒ Start/stop button	→	111	
㉓ Right-hand switch panel			
Activates/deactivates DSR	→	151	
Raises/lowers the vehicle level	→	129	
Engages/disengages power take-off			
Activates/deactivates working speed control (ADR)	→	169	
Activates/deactivates cargo compartment ventilation	→	109	
Activates/deactivates the beacon			
㉔ Steering wheel paddle shifters	→	126	
㉕ Opens the hood	→	214	
㉖ Left-hand switch panel			

Sets the working speed (ADR)	→	169	29 Seat heating	→	79
27 Light switch			Central locking system	→	52
Headlamp range adjuster			30 Driver's window lifter	→	63
28 Adjusts the driver's seat	→	68			

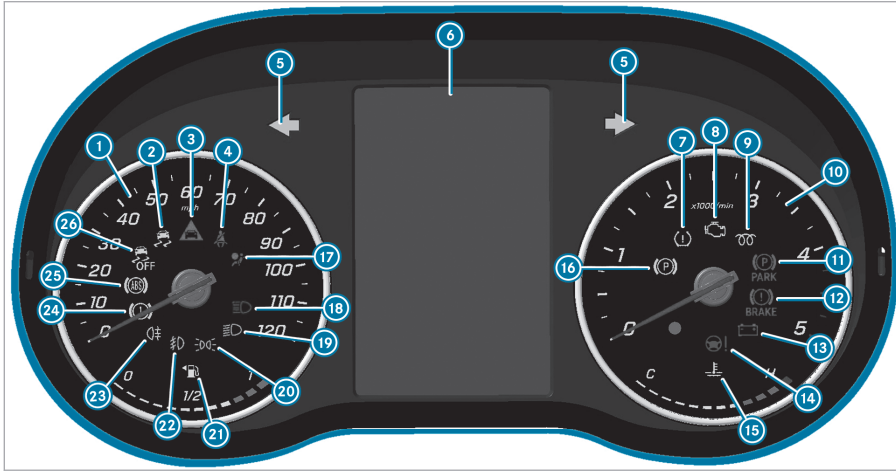

Instrument cluster with display (color)		<ul style="list-style-type: none"> ⑭ Electric power steering malfunction → 311 ⑮ Coolant temperature indicator and coolant too hot → 312 ⑯ Electric parking brake (yellow) → 305 ⑰ Restraint system → 35 ⑱ High beam → 88 ⑲ Low beam → 87 ⑳ Side lights → 87 ㉑ Fuel level indicator and fuel reserve with fuel filler cap location indicator → 312 ㉒ Fog light → 87 ㉓ Rear fog light → 87 ㉔ Brakes (yellow) → 305 ㉕ ABS malfunction → 305 ㉖ ESP® deactivated → 305
①	Speedometer → 176	
②	ESP® → 305	
③	Distance warning → 311	
④	Seat belt not fastened → 311	
⑤	Turn signal light → 88	
⑥	Instrument cluster display → 176	
⑦	Tire pressure loss warning lamp → 305	
⑧	Engine diagnostics → 312	
⑨	Preglow and malfunction in preglow system → 312	
⑩	Tachometer → 176	
⑪	PARK and (USA) or (Canada) Parking brake applied (red) → 305	
⑫	BRAKE and (USA) or (Canada) Brakes (red) → 305	
⑬	Electrical malfunction → 312	

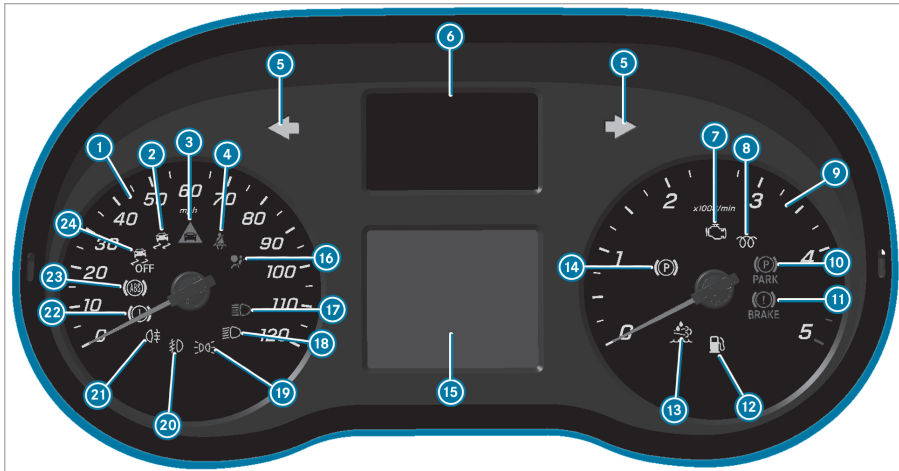

Instrument cluster with display (black and white), with steering-wheel buttons

1	Speedometer	→	176
2	ESP®	→	305
3	Distance warning	→	311
4	Seat belt not fastened	→	311
5	Turn signal light	→	88
6	Display of indicator and warning lamps		
	At least one door is not completely closed		
	Tire pressure loss	→	305
	Electric power steering malfunction	→	311
	Electrical malfunction	→	312
	SOS emergency call system (Mercedes-Benz emergency call system)		
	Active Brake Assist switched off	→	149
	ATTENTION ASSIST switched off	→	163
	Lane Keeping Assist inactive	→	169
	Highbeam Assist	→	89
	(white) Lane Keeping Assist active and ready to issue warnings and (red) Lane Keeping Assist issuing a warning	→	167
7	Engine diagnostics	→	312
8	Preglow and malfunction in preglow system		
9	Tachometer		
10	(P) and (USA) or (Canada) Parking brake applied (red)	→	305
11	BRAKE and (USA) or (Canada) Brakes (red)	→	305
12	Fuel reserve	→	312
13	DEF® supply low	→	134
14	(P) Electric parking brake (yellow)	→	305
15	Instrument cluster display	→	176
16	Restraint system		
17	High beam	→	88
18	Low beam	→	87
19	Side lights	→	87
20	Fog light	→	87
21	Rear fog light	→	87
22	(D) Brakes (yellow)	→	305

23  ABS malfunction



305









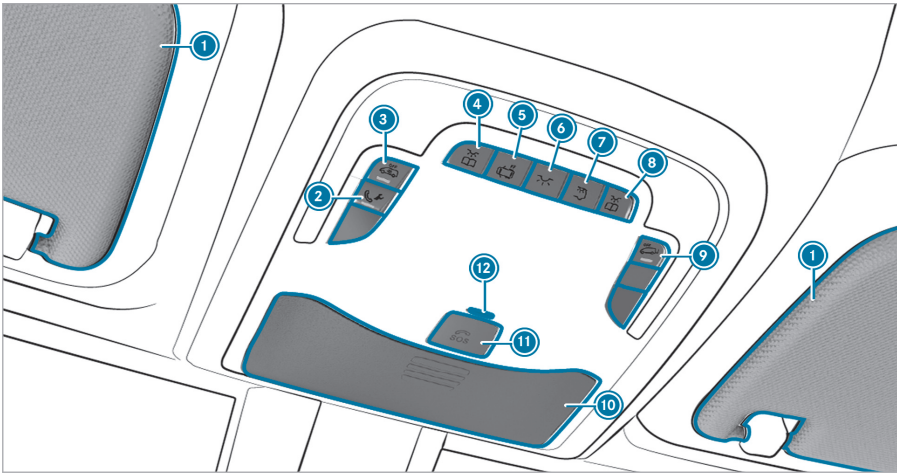

ESP® deactivated



305





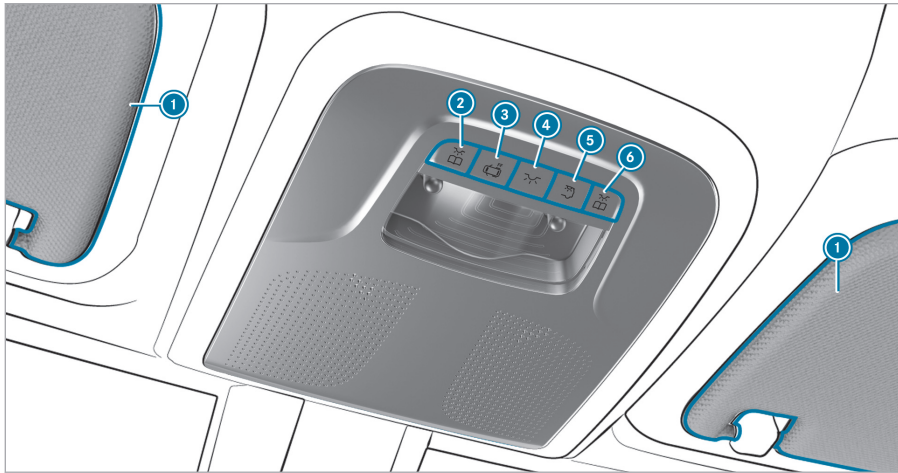

Version 1 of the overhead control panel

- | | |
|---|---|
| <p>① Sun visors</p> <hr/> <p>② Breakdown assistance call button (Mercedes me connect)</p> <hr/> <p>③  Activates/deactivates interior protection → 67</p> <hr/> <p>Activates/deactivates the bus interior lighting</p> <hr/> <p>④  Switches the left-hand reading light on/off</p> <hr/> <p>⑤  Switches automatic light control on/off</p> <hr/> <p>⑥  Switches the front interior lighting on/off</p> | <p>⑦  Switches the rear interior lighting on/off</p> <hr/> <p>⑧  Switches the right-hand reading light on/off</p> <hr/> <p>⑨  Switches the tow-away alarm on/off → 66</p> <hr/> <p>⑩ Eyeglasses compartment</p> <hr/> <p>⑪  SOS emergency call system</p> <hr/> <p>⑫  ATA indicator lamp</p> |
|---|---|



Version 2 of the overhead control panel

- ① Sun visors
- ②  Switches the left-hand reading light on/off
- ③  Switches automatic light control on/off
- ④  Switches the front interior lighting on/off
- ⑤  Switches the rear interior lighting on/off
- ⑥  Switches the right-hand reading light on/off

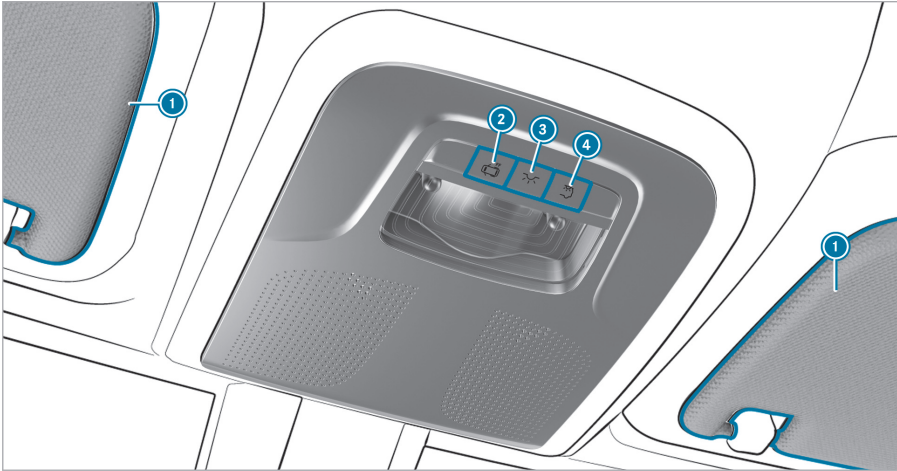

Version 3 of the overhead control panel

- ① Sun visors
- ②  Switches automatic light control on/off
- ③  Switches the front interior → lighting on/off 67
- ④  Switches the rear interior lighting on/off

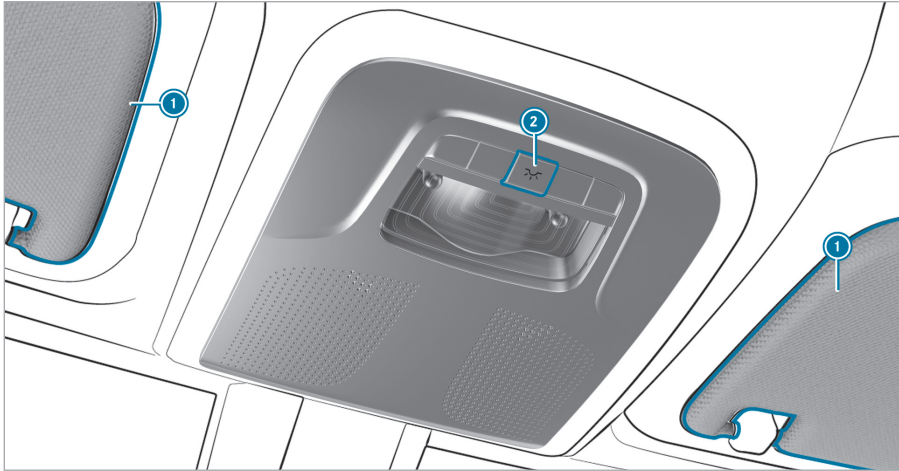







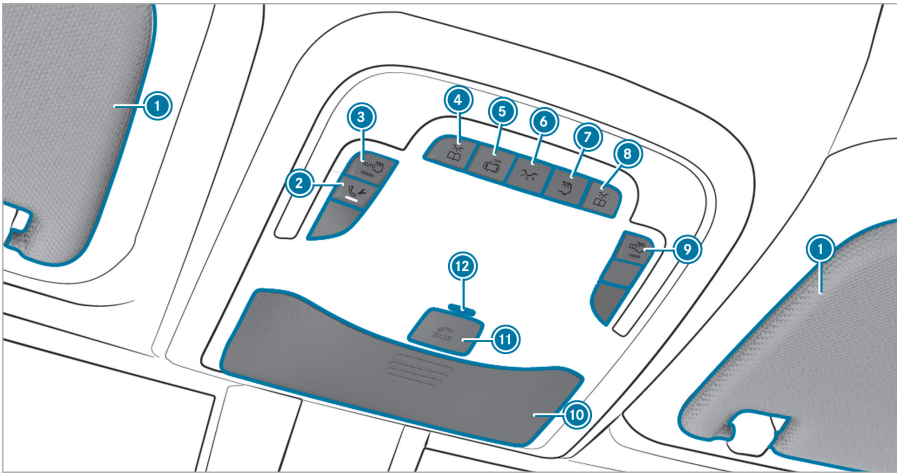

Version 4 of the overhead control panel

- ① Sun visors

- ② Switches the interior lighting on/off



Overhead control panel for vehicles with bus equipment

<p>① Sun visors</p> <hr/> <p>②  Breakdown assistance call button</p> <hr/> <p>③  Activates/deactivates the bus function → 91</p> <hr/> <p>④  Switches the left-hand reading light on/off</p> <hr/> <p>⑤  Switches automatic light control on/off → 91</p> <hr/> <p>⑥  Switches the front interior lighting on/off</p>	<p>⑦  Switches the rear interior lighting on/off → 91</p> <hr/> <p>⑧  Switches the right-hand reading light on/off</p> <hr/> <p>⑨  Activates/deactivates reading lighting in the passenger compartment → 91</p> <hr/> <p>⑩ Eyeglasses compartment</p>
--	--

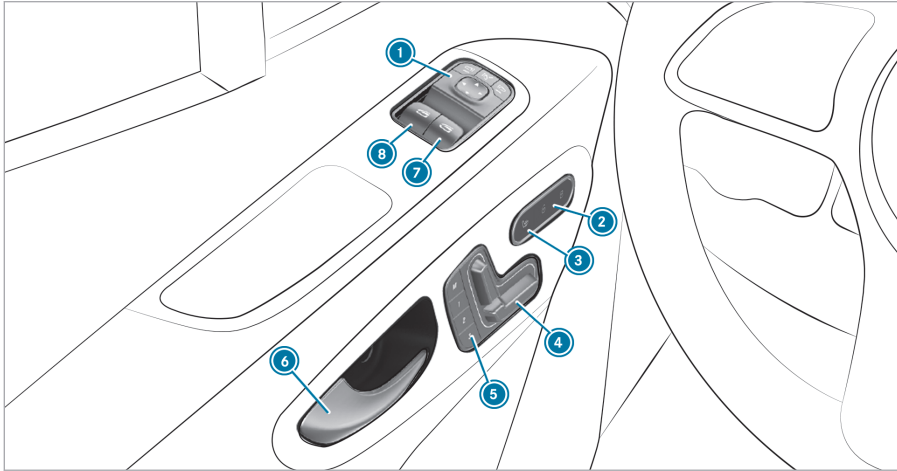



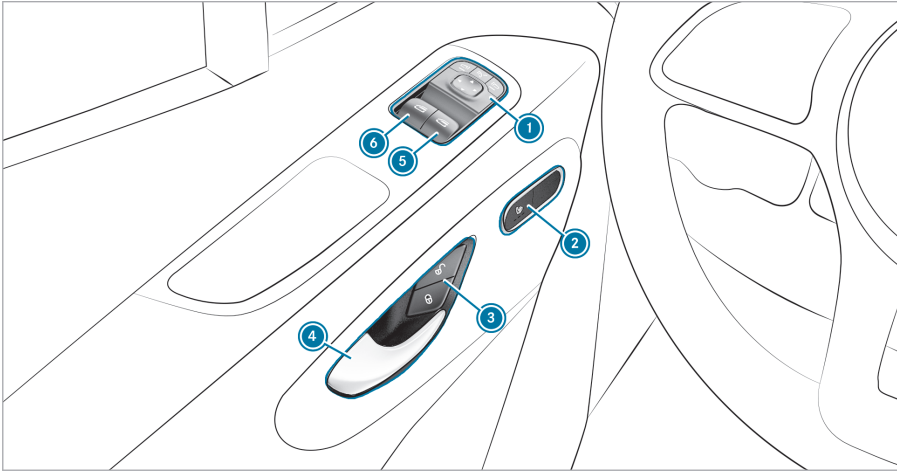

Door operating unit of vehicles with electrically adjustable seat

① Adjusts the outside mirrors →	99	⑤ M 1 2 3 Operates the memory function →	73
② Unlocks/locks the central locking system →	53	⑥ Opens the door →	51
③ Switches seat heating on/off →	79	⑦ Opens/closes the right-hand side window →	63
④ Adjusts the front seats electronically →	71	⑧ Opens/closes the left-hand side window →	63



Door operating unit of vehicles without electrically adjustable seat

① Adjusts the outside mirrors → 99	④ Opens the door → 51
②  Switches seat heating on/off → 79	⑤  Opens/closes the right-hand side window → 63
③   Unlocks/locks the central locking system → 53	⑥  Opens/closes the left-hand side window → 63

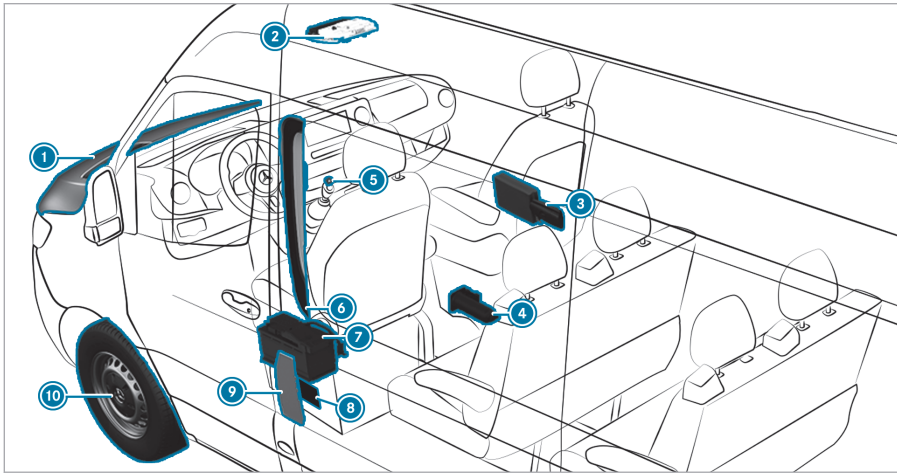

<p>① Checking and refilling operating fluids → 270</p> <p>Starting assistance → 230</p> <p>② Buttons for the SOS emergency call system and roadside assistance → 227</p> <p>③ Warning lamp → 226</p> <p>Safety vest → 226</p> <p>First-aid kit (soft-sided) → 226</p> <p>④ Vehicles with rear-wheel drive: hydraulic jack and tire-change tool kit → 236</p> <p>⑤ Hazard warning system → 88</p>	<p>⑥ B-pillar, driver's side at the level of the door handle, QR code for accessing the rescue card → 29</p> <p>Vehicles with all-wheel drive: warning notice Permissible Towing Methods → 231</p> <p>⑦ Disconnecting the starter battery</p> <p>⑧ Tire pressure table at the base of the driver's seat</p> <p>⑨ Fuel filler flap with information label on fuel type → 132</p> <p>⑩ Flat tire → 228</p>
--	--

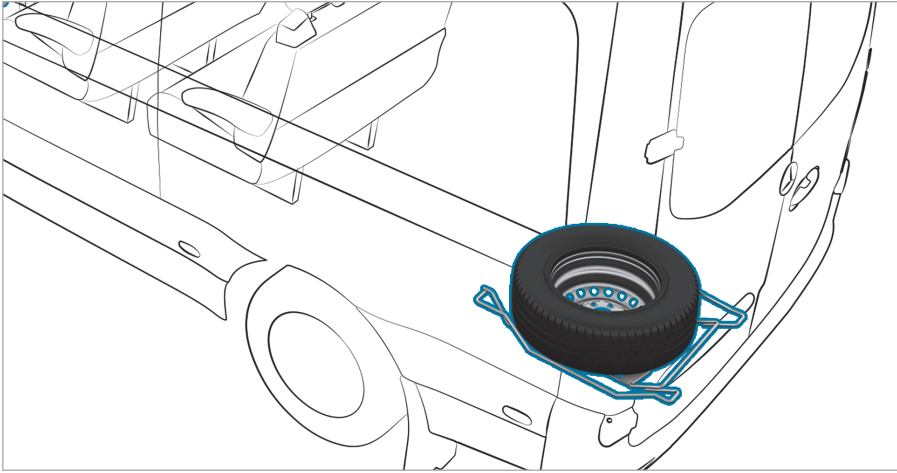

Spare wheel (example)



262

Calling up the Digital Operator's Manual

Multimedia system:

➔ Info ➔ Operator's Manual ➔ ⓘ

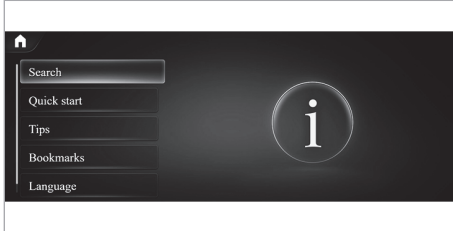

The Digital Operator's Manual describe the function and operation of the vehicle and the multimedia system.

▶ Select one of the following menu items in the Digital Operator's Manual:

- **Search:** here you can use keywords to quickly locate answers to questions concerning vehicle operation.
- **Quick start:** Here you will find the first steps for setting up the driver's seat.
- **Tips:** provides you with information on specific everyday situations for your vehicle.
- **Bookmarks:** you can access your saved personal bookmarks here.
- **Language:** you can set the language for the Digital Operator's Manual here.

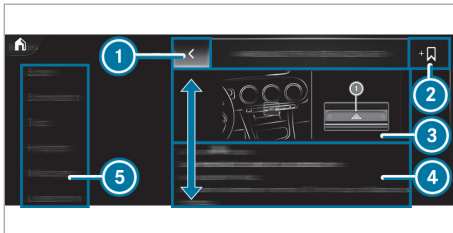

- 1 Back
- 2 Add bookmarks
- 3 Picture
- 4 Content area
- 5 Menu

Some sections in the Digital Operator's Manual, such as warning notes, can be expanded and collapsed.

Additional options for calling up the Digital Operator's Manual

▶ **Direct access:** pressing and holding down an entry in the tab bar of the multimedia system opens the corresponding content in the Digital Operator's Manual.

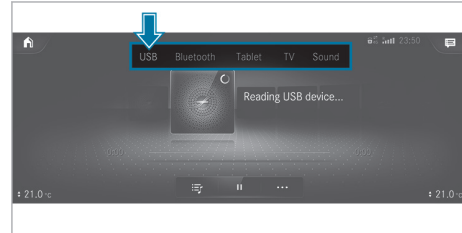

▶ **Voice Control System:** call up the Digital Operator's Manual via the voice control system.

The Digital Operator's Manual is deactivated for safety reasons while driving.

Environmental protection

 **ENVIRONMENTAL NOTE** Environmental damage due to operating conditions and personal driving style

The pollutant emission of the vehicle is directly related to the vehicle's operation.

Operate the vehicle in an environmentally responsible manner to make a contribution to environmental protection. To do this, observe the following recommendations on operating conditions and your personal driving style.

Operating conditions:

- ▶ Make sure that the tire pressures are always correct.
- ▶ Do not transport any unnecessary weight (e.g. a roof luggage rack which is no longer required).
- ▶ Observe the service intervals. A regularly serviced vehicle will contribute to environmental protection.
- ▶ Always have maintenance work carried out at a qualified specialist workshop.

Personal driving style:

- ▶ Do not depress the accelerator pedal when starting the engine.
- ▶ Do not warm up the vehicle while stationary.
- ▶ Drive carefully and maintain a sufficient distance to other vehicles.
- ▶ Avoid frequent, sudden acceleration and braking.
- ▶ Shift gears in good time and use each gear only up to $\frac{2}{3}$ of its maximum engine speed.
- ▶ Switch off the vehicle in stationary traffic.
- ▶ Drive in a fuel-efficient manner. Pay attention to the ECO display for a fuel-efficient driving style.

Environmental issues and recommendations

It is recommended that you re-use or recycle materials instead of simply disposing of them.

The relevant environmental guidelines and regulations serve to protect the environment and should be followed carefully.

Mercedes-Benz Genuine Parts

 **ENVIRONMENTAL NOTE** Environmental damage due to not using recycled reconditioned components

Mercedes-Benz AG offers recycled reconditioned components and parts with the same quality as new parts. The same entitlement from the Limited Warranty is valid as for new parts.

- ▶ Use recycled reconditioned components and parts from Mercedes-Benz AG.

 **NOTE** Impairment of the operating efficiency of the restraint systems due to the installation of accessory parts or due to repairs or welding

Air bags and seat belt tensioners as well as control units and sensors for the restraint systems may be installed in the following areas of your vehicle:

- Door frame
- Roof frame
- Doors
- Door pillars
- Sill
- Seats
- Cockpit
- Instrument cluster
- Center console

- ▶ Do not install accessory parts such as audio systems in these areas.
- ▶ Do not carry out repairs or welding.
- ▶ Have accessories retrofitted at a qualified specialist workshop.

If you use parts, tires, wheels or safety-relevant accessories that have not been approved by Mercedes-Benz, the operating safety of the vehicle may be jeopardized. Safety-relevant systems such as the brake system may malfunction. Only use Mercedes-Benz Genuine Parts or parts of equal quality. Only use tires, wheels and accessory parts that are approved for your vehicle model.

Mercedes-Benz tests original parts, conversion parts and accessory parts that have been approved for your vehicle model for reliability, safety and suitability. Despite ongoing market research, we are unable to assess other parts. We

therefore accept no responsibility for the use of such parts in Mercedes-Benz vehicles, even if they have been officially approved or independently approved by a testing center.

In some other countries, certain parts are officially approved for installation or modification only if they comply with legal requirements. All Mercedes-Benz Genuine Parts satisfy these requirements. Make sure that all parts are suitable for your vehicle.

Always specify the vehicle identification number (VIN) and the engine number when ordering Mercedes-Benz Genuine Parts (→ page 269).

Attachments, add-on equipment, installations and conversions

Notes on body/equipment mounting directives

For safety reasons, have add-on equipment produced and installed in accordance with the valid Mercedes-Benz body/equipment mounting directives. These body/equipment mounting directives ensure that the chassis and add-on equipment form one unit and that the greatest possible level of operational and driving safety is achieved.

Both vehicle manufacturers and body manufacturers must always ensure that the products they manufacture come into circulation only in a safe state and do not pose any risks to people. Otherwise, there may be consequences under civil, criminal or public law. All manufacturers are responsible for the products that they have manufactured. Manufacturers of attachments, add-on equipment, installations and conversions must guarantee compliance with Directive 2001/95/EC on general product safety.

The body manufacturer must also ensure compliance with standards concerning operational reliability (in accordance with ISO 26262) and cyber security (in accordance with ISO 21434 and UN R155).

Mercedes-Benz recommends the following procedure for safety reasons:

- Do not make any other changes to the vehicle.
- Obtain approval from the dealer named on the inside title page in the event of deviations from the approved body/equipment mounting directives.

Acceptance tests performed by public test bodies or official approvals do not rule out safety risks.

Observe the information about Mercedes-Benz Genuine Parts (→ page 21).

- You can obtain further information at a qualified specialist workshop.
- You can find further information on requesting a check for compatibility with the basic vehicle in the body/equipment mounting directives.

⚠ WARNING Risk of accident and injury in the event of improper conversions or changes to the vehicle

Conversions or changes to the vehicle can prevent systems or components from functioning properly and/or jeopardize the vehicle's operational safety.

▶ Always have conversions or changes to the vehicle carried out at a qualified workshop.

If you intend to make changes to your vehicle, Mercedes-Benz strongly recommends that you contact the dealer. They will give you all the information you need. There may be a charge for this service.

If body manufacturers and dealers make modifications that affect the final inspection of the engine, vehicle or equipment, they must accept sole responsibility for the vehicle. This also applies to marking and documenting the vehicle parts affected by the changes that they make.

You are responsible for ensuring and providing evidence that the following conditions are met:

- The vehicle complies with all relevant standards and regulations that are affected by the modification.
- The modified vehicle still meets vehicle safety standards and emissions laws and regulations.
- The modification does not impair the safety of the vehicle.

Mercedes-Benz is not responsible for the final inspection, product liability or warranty claims resulting from modification. This applies to the following points:

- The modified components or systems
- The resultant violation of emissions laws and regulations or vehicle safety standards
- All consequences resulting from the modified, less safe or even faulty vehicle

Mercedes-Benz accepts no responsibility as final manufacturer or for the resultant product liability.

Notes on the radiator

Even seemingly minor changes to the vehicle, such as attaching a radiator grill in winter, are not permitted. Do not cover the radiator. Do not use any thermal mats, insect protection covers etc.

Otherwise, the values of the vehicle's diagnostic system will be distorted. Some of these values are prescribed by law and must be correct at all times.

Notes on the cargo floor

The factory equips the vehicle with a wooden or plastic cargo floor; this is an integral part of the vehicle structure. If you have the cargo floor removed, the vehicle body may be damaged. Load securing will then be impaired and the maximum loading capacity of the tie-down points will no longer be guaranteed. Therefore, do not have the cargo floor removed.

Notes on the partition

Without a partition, vehicles that are approved as commercial vehicles (N1, N2) do not fulfill ISO 27956, which describes the equipment for properly securing a load in delivery vehicles. If the vehicle is used to transport goods, retrofitting the partition is strongly recommended, as properly securing the load in vehicles without a partition will always be complex.

Operator's Manual

This Operator's Manual describes all models, as well as standard and optional equipment of your vehicle that was available at the time of going to press. Country-specific differences are possible. Note that your vehicle may not be equipped with all the functions described. This is also the case for systems and functions relevant to safety. Therefore, your vehicle's equipment may differ from that in the descriptions and illustrations.

The original purchase agreement for your vehicle contains a list of all the systems in your vehicle.

Should you have any questions concerning equipment and operation, consult an authorized Mercedes-Benz Center.

- i** Please bear in mind that all the speed values stated in this Operator's Manual are approximate and are subject to a certain tolerance.

The Operator's Manual and Service Booklet are important documents and should be kept in the vehicle.

Note on vehicles that are equipped by body manufacturers

Always observe the body manufacturer's operating instructions. You could otherwise fail to recognize dangers.

Service and vehicle operation**Warranty**

The limited warranty for your vehicle is in accordance with the warranty terms and conditions in the Service and Warranty Information booklet.

Your Mercedes-Benz will replace and repair all factory-installed parts in accordance with the terms of the following warranty terms and conditions:

- New Vehicle Limited Warranty
- Exhaust System Warranty
- Emission Systems Warranty
- California, Connecticut, Maine, Massachusetts, New York, Pennsylvania, Rhode Island and Vermont Emission Control System Warranty
- State Warranty Enforcement Laws ("Lemon Laws")

Replacement parts and accessories are covered by the Mercedes-Benz Parts and Accessories Warranties.

These are available at any Mercedes-Benz.

- i** Should you lose your Service and Warranty Information booklet, have an Mercedes-Benz arrange for a replacement. The new Service and Warranty Information booklet will be posted to you.

Vehicle operation outside the USA or Canada

When you are traveling abroad with your vehicle, observe the following points:

- Service points or replacement parts may not be available immediately.
- Unleaded fuel for vehicles with a catalytic converter may not be available. Leaded fuel can cause damage to the catalytic converter.
- The fuel may have a considerably lower octane number. Unsuitable fuel can cause engine damage.

Certain Mercedes-Benz models are available in Europe through the European Delivery Program.

For more information, please consult a Mercedes-Benz or write to one of the following addresses.

In the USA:

Mercedes-Benz USA, LLC
 One Mercedes-Benz Drive
 Sandy Springs, GA 30328

In Canada:

Mercedes-Benz Canada, Inc.
 2680 Matheson Blvd E, Suite 400
 Mississauga, ON L4W 0A5

Maintenance

Your customer service advisor will record every service for you in the Service and Warranty Information booklet.

Roadside Assistance

Roadside Assistance offers technical help in the event of a breakdown. Your calls to the toll-free Roadside Assistance Hotline are answered by our agents 24 hours a day, 365 days a year.

1-877-762-8267 (USA)

1-800-387-0100 (Canada)

You can find further information in the Roadside Assistance brochure (USA) or the "Roadside Assistance" section in the Service and Warranty Information booklet (Canada). You will find both in the vehicle document wallet.

Change of address or change of ownership

In the event of a change of address, please send us the "Notification of Address Change" in the Service and Warranty Information booklet, or simply call the Customer Assistance Center (USA) on the hotline number 1-877-762-8267 or Customer Service (Canada) on 1-800-387-0100. This will give us the opportunity to get in touch with you as soon as possible when necessary.

If you sell your Mercedes, please leave the entire literature in the vehicle so that it is available to the next owner. If you have purchased a used vehicle, please send us the "Notice of Purchase of Used Car" in the Service and Warranty Information booklet or call the Customer Assistance Center (USA) on the hotline number 1-877-762-8267 or Customer Service (Canada) on 1-800-387-0100.

Possible danger due to substances hazardous to health

In compliance with Proposition 65 ("Prop65"), the following detachable label has been added to each vehicle sold in California:



Operating safety

⚠ WARNING Risk of accident due to malfunctions or system failures

If you do not have the prescribed service/maintenance work or any required repairs carried out, this could result in malfunctions or system failures.

- ▶ Always have the prescribed service and maintenance work or any required repairs carried out in a qualified specialist workshop.

⚠ WARNING Risk of accident or injury due to incorrect modifications on electronic component parts

Modification of electronic components, their software or wiring could impair their function and/or the function of other networked component parts or safety-relevant systems.

This can endanger the operating safety of the vehicle.

- ▶ Never tamper with the wiring and electronic component parts or their software.
- ▶ You should have all work on electrical and electronic components carried out at a qualified specialist workshop.

Please observe the "Vehicle electronics" section in the "Technical data".

⚠ WARNING Risk of fire caused by flammable material on hot exhaust system components

Flammable material such as leaves, grass or twigs may ignite if they come into contact with hot parts of the exhaust system.

- ▶ When driving on an unpaved road or off-road, check the vehicle underside regularly.
- ▶ In particular, remove trapped plant parts or other flammable material.
- ▶ If there is damage, consult a qualified specialist workshop immediately.

ℹ NOTE Damage to the vehicle due to driving too fast and due to impacts to the vehicle underbody or suspension components

In the following situations, in particular, there is a risk of damage to the vehicle:

- The vehicle becomes grounded, e.g. on a high curb or an unpaved road
- The vehicle is driven too fast over an obstacle, e.g. a curb, speed bump or pothole
- A heavy object strikes the underbody or suspension components

In situations such as these, damage to the body, underbody, suspension components, wheels or tires may not be visible. Components damaged in this way can unexpectedly fail or, in the case of an accident, may no longer absorb the resulting force as intended.

If the underbody paneling is damaged, flammable materials such as leaves, grass or twigs can collect between the underbody and the underbody paneling. These materials may ignite if they come into contact with hot parts of the exhaust system.

- ▶ Have the vehicle checked and repaired immediately at a qualified specialist workshop.

or

- ▶ If driving safety is impaired while continuing your journey, pull over and stop the vehicle immediately, while paying attention to road and traffic conditions, and contact a qualified specialist workshop.

Declarations of conformity and notes on driving in different countries

Country-specific information for regulatory radio components

Notes when crossing national borders

You must observe the regulatory provisions concerning radio for the country in which you are currently driving when operating the vehicle.



USA: "The wireless devices of this vehicle comply with Part 15 of the FCC Rules. Operation is subject to the following two conditions: 1) These devices may not cause harmful interference, and 2) These devices must accept any interference received, including interference that may cause undesired operation. Changes or modifications not expressly approved by the party responsible for compliance could void the user's authority to operate the equipment."

Canada: "The wireless devices of this vehicle comply with Industry Canada licence-exempt RSS standard(s). Operation is subject to the following two conditions: (1) These devices may not cause interference, and (2) These devices must accept any interference, including interference that may cause undesired operation of the device".

USA: "Wireless charging system for mobile devices (Model: WMI3.5 Wireless Mobile Interface): This Device complies with Part 18 of the FCC Rules."

The name and address of the responsible party is:

Molex CVS
Mizarstraße 3
12529 Schönefeld
Germany

Diagnostics connection

The diagnostics connection is a technical interface in the vehicle. It is used, for example, during repair and maintenance work or for issuing readouts of vehicle data in a specialist workshop. Diagnostic devices should therefore be connected only in a qualified specialist workshop.

⚠ WARNING Risk of accident due to connecting devices to the diagnostics connection

If you connect devices to the diagnostics connection of the vehicle, the function of vehicle systems and operating safety may be impaired.

- ▶ For safety reasons, we recommend that you use and connect only products approved by an authorized Mercedes-Benz Service Center.

⚠ WARNING Risk of accident due to objects in the driver's footwell

Objects in the driver's footwell may impede pedal travel or block a depressed pedal.

This will jeopardize the operating- and road safety of the vehicle.

- ▶ Stow all objects in the vehicle securely so that they cannot get into the driver's footwell.
- ▶ Make sure that there is always sufficient clearance for the pedals.
- ▶ Always install the floor mats securely and as prescribed.
- ▶ Do not use loose floor mats and do not place floor mats on top of one another.

! **NOTE** Battery discharging from using devices connected to the diagnostics connection

Using devices at the diagnostics connection drains the battery.

- ▶ Check the charge level of the battery.
- ▶ If the charge level is low, charge the battery, e.g. by driving a considerable distance.

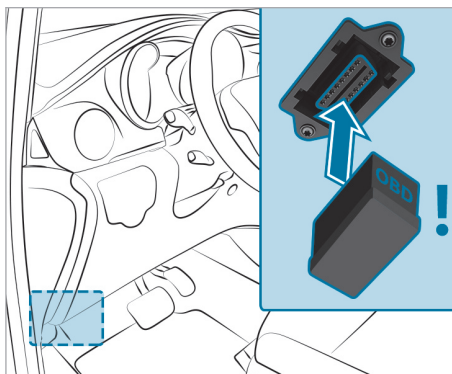

The connection and use of another device on the diagnostics connection can have the following effects:

- Malfunctions in the vehicle system
- Permanent damage to vehicle components

Please refer to the warranty terms and conditions regarding this.

In addition, connecting equipment to the diagnostics connection may lead to emissions monitoring information being reset, for example. This may lead to the vehicle failing to meet the requirements of the next emissions inspection during the main inspection.

Notes on changes to the engine output

Output increases can:

- Change the emission values.
- Lead to malfunctions.
- Result in consequential damage.

The operating safety of the vehicle is not guaranteed in all situations.

Any tampering with the engine management, for example, in order to increase the vehicle's engine output will lead to the loss of the New Vehicle Limited Warranty and other warranty entitlements.

If you sell the vehicle, inform the buyer of any alterations to the vehicle's engine output. Otherwise, this may constitute a punishable offense under national law.

Qualified specialist workshop

A qualified specialist workshop has the necessary special skills, tools and qualifications to correctly

carry out any necessary work on your vehicle. This particularly applies to work relevant to safety.

Always have the following work on the vehicle carried out at a qualified specialist workshop:

- Safety-relevant works
- Service and maintenance work
- Repair work
- Modifications as well as installations and conversions
- Work on electronic component parts

Mercedes-Benz recommends that you use an authorized Mercedes-Benz for this purpose.

Vehicle registration

Mercedes-Benz may ask its service centers to carry out technical inspections on certain vehicles. The quality or safety of the vehicles is improved as a result of the inspection.

Mercedes-Benz can only inform you about vehicle checks if it Mercedes-Benz has your registration data.

In the following cases, your vehicle may not be registered to you yet:

- you did not purchase your vehicle at an authorized specialist dealer.
- your vehicle has not yet been inspected at a Mercedes-Benz Service Center.

It is advisable to register your vehicle with a Mercedes-Benz Service Center.

Inform Mercedes-Benz as soon as possible about any change in address or vehicle ownership.

You can do this at a Mercedes-Benz Service Center, for example.

Correct use of the vehicle

If you remove warning stickers, you or others may fail to recognize the dangers. Leave warning stickers in position.

Observe the following information in particular when operating the vehicle:

- Safety notes in these operating instructions
- Technical data for the vehicle
- Traffic rules and regulations of the country in which you are currently located

- Laws pertaining to motor vehicles and safety standards of the country in which you are currently located
- Radio regulations of the country in which you are currently located

Multi-purpose vehicle

⚠ WARNING Risk of accident when the center of gravity is too high

The vehicle may start to skid and rollover in the event of sudden steering maneuvers and/or when the vehicle's speed is not adapted to the road conditions.

▶ Always adapt your speed and driving style to the vehicle's driving characteristics and to the prevailing road and weather conditions.

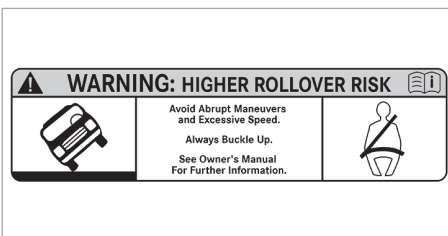

USA

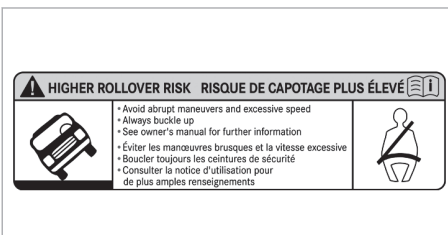

Canada

Utility vehicles have a significantly higher rollover rate than other types of vehicles.

Unsafe operation of the vehicle can result in an accident or rollover, as well as serious or even fatal injuries.

In a rollover crash, an unbelted person is significantly more likely to die than a person wearing a seat belt.

You and all vehicle occupants should always wear seat belts.

Notes for persons with electronic medical aids

Mercedes-Benz AG cannot, despite carefully developing vehicle systems, completely rule out the interaction of vehicle systems with electronic medical aids such as cardiac pacemakers.

In addition, there are components built into the vehicle that, regardless of the operating status of your vehicle, can generate magnetic fields on a par with permanent magnets. These fields can be found, for example, in the area around the multimedia and sound system or also in the seating area, depending on the vehicle equipment.

For this reason, the following can occur in isolated cases, depending on the aids used:

- Medical aids malfunctioning
- Adverse health effects

Observe the notes and warnings of the manufacturer of the medical aids; if in doubt, contact the device manufacturer and/or your doctor. If there is continuing uncertainty concerning the possibility of medical aids malfunctioning, Mercedes-Benz AG recommends using only few electrical vehicle systems and/or maintaining a distance from the components.

Only have repairs and maintenance work in the area of the following components carried out at a qualified specialist workshop:

- Vehicle components carrying live voltage
- Transmission antenna
- Multimedia system and sound system

If you have any queries or suggestions, consult a qualified specialist workshop.

Problems with your vehicle

If you experience a problem with your vehicle, particularly one that you believe may affect vehicle safety, please contact a Mercedes-Benz immediately to have the problem diagnosed and rectified.

If the problem is not resolved to your satisfaction, please contact a Mercedes-Benz again or write to one of the following addresses.

In the USA:

Mercedes-Benz USA, LLC
Customer Assistance Center
One Mercedes-Benz Drive
Sandy Springs, GA 30328

In Canada:

Mercedes-Benz Canada, Inc.
Customer Assistance Center
2680 Matheson Blvd E, Suite 400
Mississauga, Ontario L4W 0A5

"Reporting safety defects"

USA only:

The following text is published as required of manufacturers under Title 49, Code of U.S. Federal Regulations, Part 575 pursuant to the "National Traffic and Motor Vehicle Safety Act of 1966".

If you believe that your vehicle has a defect which could cause a crash or could cause injury or death, you should immediately inform the National Highway Traffic Safety Administration (NHTSA) in addition to notifying Mercedes-Benz Vans, LLC.

If NHTSA receives similar complaints, it may open an investigation, and if it finds that a safety defect exists in a group of vehicles, it may order a recall and remedy campaign. However, NHTSA cannot become involved in individual problems between you, your dealer, or Mercedes-Benz Vans, LLC.

To contact NHTSA, you may call the Vehicle Safety Hotline toll-free at 1-888-327-4236 (TTY: 1-800-424-9153); go to <https://www.safercar.gov>; or write to: Administrator, NHTSA, 400 Seventh Street, SW., Washington, DC 20590, USA.

You can find more information on vehicle safety on <https://www.safercar.gov>

Canada only:

The following text is published as required of manufacturers under subsection 18.4 (4) of the Motor Vehicle Safety Regulations.

If you believe that your vehicle has a defect which could cause a crash or could cause injury or death, you should immediately inform Transport Canada in addition to notifying Mercedes-Benz Canada Inc.

If Transport Canada received similar complaints, it may open an investigation, and if it finds that a safety defect exists in a group of vehicles, it may order a recall and remedy campaign. However, Transport Canada cannot become involved in individual problems between you, your dealer, or Mercedes-Benz Canada Inc.

To contact Transport Canada, you may call the Defect Investigations and Recalls Division toll-free in Canada at 1-800-333-0510 or 819-994-3328 in the Gatineau-Ottawa area or internationally; may also go to the following websites for more information:

- English: www.tc.gc.ca/recalls
- French: www.tc.gc.ca/rappels

Limited Warranty

! **NOTE** Damage to the vehicle arising from violation of these operating instructions.

Damage to the vehicle can arise from violation of these operating instructions.

Such damage is not covered by either the Limited Warranty or the new or used-vehicle warranty.

▶ Observe the instructions in these operating instructions on proper operation of your vehicle as well as regarding possible vehicle damage.

QR codes for rescue card

The QR code stickers are affixed to the B-pillar on the driver's and front passenger side. In the event of an accident, emergency services can use the QR code to quickly determine the corresponding rescue card for your vehicle. The current rescue card contains the most important information about your vehicle in a compact form, e.g. the routing of the electric lines.

Further information is available at: <https://rk.mb.com/de/#rescue-sticker>

Data storage

Data processing in the vehicle

Electronic control units

Electronic control units are installed in your vehicle. Control units process data they receive from vehicle sensors, for example, generate themselves or exchange between themselves. Some control units are required for the safe operation of your vehicle. For example, some assist you when driving, such as driver assistance systems, while others enable functions serving comfort or infotainment.

The following provides you with general information regarding data processing in the vehicle. Additional information regarding which data in your vehicle is collected, saved and transmitted to third parties and for what purpose can be found in the information directly related to the functional characteristics in question in the respective Operator's Manual. This information is available both online

and digitally, depending on the vehicle's equipment.

Personal data

A unique vehicle identification number identifies every vehicle. Depending on the country, this vehicle identification number can be used by, for example, governmental authorities to determine the owner's identity. There are other possibilities for using data collected from the vehicle to identify the owner or driver, such as the license plate number.

Therefore, data generated or processed by control units may be attributable to a person or, under certain conditions, become attributable to a person. Depending on which vehicle data are available, it may be possible to make inferences about, for example, your driving behaviour, location, route or use patterns.

Legal requirements regarding the disclosure of data

If legally required to do so, manufacturers are legally obliged on a case-by-case basis to provide data stored by the manufacturer to governmental entities, upon request and to the extent required. For example, this may come into effect during the investigation of a criminal offense.

Governmental entities are themselves authorised to read out data from the vehicle in individual cases and within the applicable legal framework. Following an accident, information that can help with an investigation can be taken from the air bag control unit, for example.

Operational data in the vehicle

Data processed by control units for operation of the vehicle.

This includes the following data, for example:

- Vehicle status information such as the speed, longitudinal acceleration, lateral acceleration, number of wheel revolutions or the fastened seat belts display
- Ambient conditions, such as temperature, rain sensor or distance sensor

Generally, these are short-term data and will not be stored beyond the period of operation, and is processed only within the vehicle itself. Control units, for example vehicle keys, often contain data memories. Their use permits the temporary or permanent documentation of technical information regarding the vehicle's operating state, component loads, maintenance requirements and technical events or malfunctions.

Depending on the technical equipment, the following data are stored:

- Operating status of system components, such as fill levels, tire pressure or battery status
- Malfunctions or defects in important system components, such as lights or brakes
- System reactions in special driving situations, such as air bag deployment or the intervention of stability control systems
- Information on events leading to vehicle damage

In certain cases, storing data that would have otherwise been temporary may be required. This may be the case if the vehicle has detected a malfunction, for example.

If you use services such as repair services and maintenance work, stored operational data and the vehicle identification number can be read out and used as required. They can be read out from the vehicle by service network employees, such as those working for workshops, manufacturers or third parties (e.g. breakdown services). The same applies for warranty claims and quality assurance measures.

In general, the readout is performed via the legally prescribed port for the diagnostics connection in the vehicle. The operating data read out documents the vehicle's or individual components' technical condition and help to diagnose faults, ensure compliance with warranty obligations and bring about improvements in quality. To that end, this data, and in particular information pertaining to component loads, technical events, malfunctions and other faults may be transmitted along with the vehicle identification number to the manufacturer. Furthermore, the manufacturer is subject to product liability. For this reason, the manufacturer also uses operational data from the vehicle, for example, for recalls. These data can also be used to examine the customer's warranty and legal guarantee claims.

Fault memories in the vehicle can be reset by a service outlet or at your request as part of repair or maintenance work.

Functions serving comfort and infotainment

You can store the vehicle's settings for comfort and customisations, and can change or reset them at any time.

Depending on the vehicle equipment, this includes the following settings, for example:

- Seat and steering wheel positions
- Suspension tuning and climate control settings
- Customisation settings, such as interior lighting

Depending on the selected equipment, you can import data into vehicle infotainment functions yourself.

Depending on the vehicle equipment, this includes the following data, for example:

- Multimedia data, such as music, films or photos for playback in an integrated multimedia system
- address book data for use in connection with an integrated hands-free system or an integrated navigation system
- entered navigation destinations
- data for the use of Internet services

These data for functions serving comfort and infotainment may be saved locally in the vehicle or on a device connected to the vehicle, such as a smartphone, USB flash drive or MP3 player. Data that you have entered yourself can be deleted at any time.

These data are transmitted only from the vehicle to third parties at your request. This applies in particular when using online services from your own selected settings.

Smartphone integration (e.g. Android Auto or Apple CarPlay®)

If your vehicle is equipped accordingly, you can connect your smartphone or another mobile end device to the vehicle. You can then control them through the control elements integrated into the vehicle. Images and audio from the smartphone can be relayed through the multimedia system. Certain information is simultaneously transferred to your smartphone. Depending on the type of integration, this includes position data, day/night mode and other general vehicle statuses. For more information, please consult the Operator's Manual for the vehicle or in the infotainment system.

This integration allows the use of selected smartphone apps, such as navigation or music player apps. There is no further interaction between the smartphone and the vehicle; in particular effective access to vehicle data. The type of additional data processing is determined by the provider of the app being used. Permissible settings, if any, will

depend on the specific app and your smartphone's operating system.

Online services

Wireless network connection

If your vehicle has a wireless network connection, data can be exchanged between your vehicle and other systems. The wireless network connection is made possible by the vehicle's own transmitter and receiver or by a mobile end device that you have brought into the vehicle, for example, a smartphone. Online functions can be used via this wireless network connection. This includes online services and applications/apps provided to you by the manufacturer or by other providers.

Manufacturer's own services

Regarding the manufacturer's online services, the individual functions are described by the manufacturer in a suitable place, for example, in the Operator's Manual or on the manufacturer's website, where the relevant data protection information is also given. Personal identification data may be used to provide online services. Data is exchanged via a secure connection, e.g. the manufacturer's designated IT systems. Any personal data which are collected, processed and used, other than for the provision of services, is done so exclusively on the basis of legal permission. This is the case, for example, for a legally prescribed emergency call system, a contractual agreement or when consent has been given.

You can have services and functions, some of which are subject to a fee, activated or deactivated. This excludes legally prescribed functions and services, such as an emergency call system.

Services of third parties

If you use online services from other providers (third parties), these services are the responsibility of the provider in question and subject to that provider's data protection conditions and terms of use. As a general rule, the manufacturer has no influence on the content exchanged.

For this reason, when services are provided by third parties, please ask the service provider in question for information about the type, extent and purpose of the collection and use of personal data.

Onboard Logic Unit (OLU)

The Onboard Logic Unit (OLU) is available to commercial customers.

It contains control units, including antennas for connection via wireless networks, that permit the

exchange of data between your vehicle and other systems. The control units can be used in conjunction with service provided by a third party. Under certain circumstances, these services may alter the basic configuration of the vehicle and could affect the performance of certain vehicle functions.

For further information about specific services, read the Operator's Manual of the third-party provider. For further information about the Onboard Logic Unit, consult an authorized Mercedes-Benz Center.

If you, yourself, do not own and are not responsible for the vehicle, you may not know the current status of the Onboard Logic Unit. For further information concerning the services which are currently active, including any data which may be being processed as defined by the GDPR, please contact the person responsible for the vehicle.

Data protection rights

Depending on the country, the equipment and functions of your vehicle, and the services and service offerings used, you are entitled to different data protection rights. Further information on data protection and your data protection rights can either be found on the manufacturer's website or you will receive this information as part of the various services and service offers. There, you will also find the contact information for the manufacturer and its data protection officer.

At a workshop, for example, with the support of a specialist and possibly for a fee, you can have data read out which is stored only locally in the vehicle.

Event Data Recorders

USA only:

This vehicle is equipped with an event data recorder (EDR). The main purpose of an EDR is to record, in certain crash or near crash-like situations, such as an air bag deployment or hitting a road obstacle, data that will assist in understanding how a vehicle's systems performed. The EDR is designed to record data related to vehicle dynamics and safety systems for a short period of time, typically 30 seconds or less.

The EDR in this vehicle is designed to record such data as:

- How various systems in your vehicle were operating;
- Whether or not the driver and passenger safety belts were buckled/fastened;

- How far (if at all) the driver was depressing the accelerator and/or brake pedal; and,
- How fast the vehicle was traveling.

These data can help provide a better understanding of the circumstances in which crashes and injuries occur. NOTE: EDR data are recorded by your vehicle only if a non-trivial crash situation occurs; no data are recorded by the EDR under normal driving conditions and no personal data (e.g., name, gender, age, and crash location) are recorded. However, other parties, such as law enforcement could combine the EDR data with the type of personally identifying data routinely acquired during a crash investigation.

Access to the vehicle and/or the EDR is needed to read data that is recorded by an EDR, and special equipment is required. In addition to the vehicle manufacturer, other parties that have the special equipment, such as law enforcement, can read the information by accessing the vehicle or the EDR.

EDR data may be used in civil and criminal matters as a tool in accident reconstruction, accident claims, and vehicle safety. Since the Crash Data Retrieval CDR tool that is used to extract data from the EDR is commercially available, Mercedes-Benz Vans, LLC („MBV“) expressly disclaims any and all liability arising from the extraction of this information by unauthorized Mercedes-Benz personnel.

MBV will not share EDR data with others without the consent of the vehicle owners or, if the vehicle is leased, without the consent of the lessee.

Exceptions to this representation include responses to subpoenas by law enforcement; by federal, state or local government; in connection with or arising out of litigation involving MBV or its subsidiaries and affiliates; or, as required by law.

Warning: The EDR is a component of the Restraint System Module. Tampering with, altering, modifying or removing the EDR component may result in a malfunction of the Restraint System Module and other systems.

State laws or regulations regarding EDRs that conflict with federal regulation are pre-empted. This means that in the event of such conflict, the federal regulation governs. As of Dec 2016, 17 states have enacted laws relating to EDRs.

data storage medium in your vehicle document wallet and with latest updates on the following website:

<https://www.mercedes-benz.com/opensource>

Registered trademarks

- Bluetooth® is a registered trademark of Bluetooth SIG Inc.
- DTS™ is a registered trademark of DTS, Inc.
- Dolby® and MLP™ are registered trademarks of DOLBY Laboratories.
- ESP® and PRE-SAFE® are registered trademarks of Mercedes-Benz Group AG.
- HomeLink® is a registered trademark of Gen-tex Corporation.
- iPod® and iTunes® are registered trademarks of Apple Inc.
- Burmester® is a registered trademark of Burmester Audiosysteme GmbH.
- Microsoft® and Windows Media® are registered trademarks of Microsoft Corporation.
- SiriusXM® is a registered trademark of Sirius XM Radio Inc.
- HD Radio™ is a registered trademark of iBiquity Digital Corporation.
- Gracenote® is a registered trademark of Gracenote, Inc.
- ZAGAT Survey® and related brands are registered trademarks of Zagat Survey, LLC.

Copyright



Free and open source software

Information on licenses for free and open-source software used in your vehicle can be found on the

Brief overview of most important points

Basic information

Make sure that the following prerequisites in particular have been met, so that the components of the restraint system are able to provide the intended level of protection:

- Sit correctly (→ page 33).
- Fasten the seat belt correctly (→ page 34).
 - Function of the  seat belt warning lamp (→ page 35).
- The  restraint system warning lamp has not gone out after the self-test (→ page 35).

For clear understanding

The chapter "Occupant safety" includes information on equipment, functions and behaviors that contribute directly to safety of vehicle occupants.

The information is structured as follows:

- **The most important information in brief:** in this chapter, you are provided with an overview of the relationship between the restraint system and the correct behavior of all vehicle occupants.
- **Specific information:** in further sections of the chapter "Occupant safety", you can find specific information on the equipment and functions of the restraint system.
- **Keyword directory:** you can also find certain subjects in this Operator's Manual using the keyword directory.

Information on the following subjects, among others, is not provided in the chapter "Occupant safety":

- Children in the vehicle (→ page 41)
- Driving and driving safety systems (→ page 143)
- Stowage areas (→ page 209)

Defining generic terms clearly

In this Operator's Manual, the following generic terms are used:

- **Occupant safety:** comprises the components and system functions which help to minimize, as much as possible, the stresses on and consequences for vehicle occupants during an accident.
- **Restraint system:** comprises those components which, along with the vehicle structure, help prevent vehicle occupants from potentially

coming into contact with parts of the vehicle interior. The seat belts and air bags, for example, are components of the restraint system.

- **Child restraint system:** you can find all information on this subject in the chapter "Children in the vehicle" (→ page 41).

Be diligent

For the components of the restraint system to provide the intended level of protection, it is essential that you are seated correctly and that the seat belt is correctly secured.

Bear in mind that negligence when adjusting your sitting position and fastening the seat belt can have serious consequences. Be diligent and make sure before starting every journey that all vehicle occupants are sitting correctly and have fastened their seat belts properly.

Information on the correct seat position

The seat position must be correct in order for the components of the restraint system to provide the intended level of protection.

The seat position influences both the protection provided by the seat belt and the additional protection provided by the air bag.

A correct seat position in which the seat is nearly perfectly upright and a correctly fastened seat belt reduce the risks posed by the air bag when it is deployed.

WARNING Risk of injury or death due to an incorrect seat position

If you deviate from the correct seat position, the air bag cannot provide its intended protective function.

Each vehicle occupant must make sure of the following.

- ▶ Put the seat in the correct position.
- ▶ Fasten seat belts correctly. Pregnant women must take particular care to ensure that the lap belt never lies across the abdomen.
- ▶ Observe the following information.

In order for the restraint system to provide the intended level of protection, observe the following information:

- Before starting your journey, adjust your seat correctly (→ page 68).

When doing so, make sure you are able to fasten your seat belt correctly. The shoulder belt strap must be routed forward from the seat belt outlet over the center of your shoulder.

- Keep your distance from the air bags, especially the front air bags. Set the driver's seat and co-driver seat as far back as possible while making sure the seat belt is fastened correctly.
- If persons are sitting on the rear seats, vehicle occupants should maintain a sufficient distance to the parts of the vehicle interior in front of them.
- Make sure there are no people, animals or objects between the vehicle occupants and an air bag.
- If you are the driver, observe the following information on the correct position of the driver's seat (→ page 68).

Hold the steering wheel only by the steering wheel rim. This allows the driver's air bag to fully deploy.

- Assume a nearly upright sitting posture, with your buttocks positioned as far back as possible in the gap between the seat cushion and the seat backrest.

Your back must lie as flatly and as firmly as possible against the seat backrest.

- While driving, do not lean forward and do not lean against the door or side window. You may otherwise be in the deployment area of the air bags.
- Sit with their feet resting on the floor, if possible. Your thighs are slightly supported by the seat cushion.

Do not put your feet on the cockpit, for example. Your feet may otherwise be in the deployment area of the air bag.

- Fasten the seat belt correctly.

Notes on wearing the seat belt correctly

Always fasten your seat belt correctly before starting a journey. Only a seat belt that is worn correctly can provide the intended level of protection.

⚠ WARNING Risk of injury or death due to incorrectly fastened seat belt

If the seat belt is not worn correctly, it cannot perform its intended protective function.

In addition, an incorrectly fastened seat belt can also cause injuries, for example, in the event of an accident or when braking or changing direction suddenly.

▶ Always ensure that all vehicle occupants have their seat belts fastened correctly and are sitting properly.

⚠ WARNING Risk of injury or death when additional restraint systems are not used for persons with a smaller stature

Persons under 5 ft (1.50 m) tall cannot wear the seat belt correctly without a suitable additional restraint system.

▶ Always secure persons under 5 ft (1.50 m) tall in a suitable restraint system.

Each vehicle occupant must observe the following notes in particular:

- The seat belt must not be twisted.
- The shoulder belt strap must be routed forward from the seat belt outlet over the center of your shoulder.
- The shoulder belt strap should neither touch your neck nor be routed under your arm or behind your back.
- The lap belt must be routed as low down across the hips as possible.

In addition, push the lap belt down as far as possible across your hips and pull tight with the shoulder belt strap. Never route the lap belt across your abdomen.

Pregnant women must also take particular care with this.

- After being tightened, the shoulder belt strap and lap belt must fit snugly against the body.
- Avoid wearing bulky clothing, e.g. a winter coat.
- Never route the seat belt across sharp, pointed, abrasive or fragile objects.
- Only one person should use each seat belt at any one time.
- Never secure objects with a seat belt if the seat belt is being used by one of the vehicle's occupants.

Also ensure that no objects, e.g. a cushion, are ever placed between a person and the seat.

Fastening and adjusting seat belts

If the seat belt is pulled quickly or sharply, the seat belt retractor locks. The seat belt strap cannot be pulled out any further.

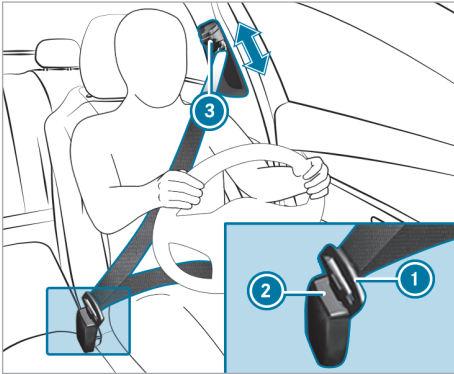

- ▶ Always engage the seat belt tongue ① of the seat belt into the seat belt buckle ② of the corresponding seat.
- ▶ **To adjust the seat belt height:** press button ③ on the seat belt outlet and slide the seat belt outlet to the desired position.
- ▶ **To engage the seat belt outlet:** release button ③ and ensure that the seat belt outlet engages.

! **NOTE** Deployment of components of the restraint system when the front passenger seat is unoccupied and a seat belt is buckled

When the front passenger seat is unoccupied and the seat belt tongue of the seat belt is engaged in the seat belt buckle, components of the restraint system may deploy unnecessarily on the front passenger side, e.g. the Emergency Tensioning Device.



- ▶ Only buckle the seat belts as intended.

i Observe the information on the special seat belt retractor of the seat belt (→ page 45).

Function of the restraint system warning lamp

When the vehicle is switched on, a self-test is performed, during which the restraint system warning lamp  lights up. It goes out no later than a few seconds after the vehicle is started. The components of the restraint system are then functional.

A malfunction has occurred in the restraint system in the following cases:

- The restraint system warning lamp  does not light up or lights up continuously when the vehicle is switched on.
- The restraint system warning lamp  lights up continuously or repeatedly during a journey.

If components of the restraint system have been deployed, the restraint system warning lamp  lights up continuously.

! **WARNING** Risk of injury due to malfunctions in the restraint system

Components in the restraint system may be activated unintentionally or not deploy as planned in an accident.

- ▶ Have the restraint system checked and repaired immediately at a qualified specialist workshop.

Mercedes-Benz recommends that you have the vehicle towed to a qualified specialist workshop.

Function of the seat belt warning lamp

The  seat belt warning lamp in the instrument cluster display reminds you that all vehicle occupants must fasten their seat belts correctly.

The  seat belt warning lamp lights up for six seconds each time the vehicle is switched on.

A warning tone may also sound.

After the vehicle is started, the seat belt warning goes out as soon as the driver's and the front passenger's seat belts are fastened.

While driving, the seat belt warning lights up in the following cases:

- if the vehicle's speed is higher than 15 mph (25 km/h) and the driver's or front passenger's seat belt is not fastened
- if the driver or front passenger unfastens their seat belt during the journey

Information on the child restraint system

When installing a child restraint system, observe the notes in "Children in the vehicle" (→ page 41).

Notes on the child restraint system on the front passenger seat

▲ WARNING Risk of injury or fatal injuries if the front passenger air bag is enabled

If the front passenger air bag is enabled, a child on the front passenger seat may be struck by the front passenger air bag in the event of an accident.

▶ NEVER use a rearward-facing child restraint system on a seat with an ENABLED FRONT AIR BAG. This can result in the DEATH of or SERIOUS INJURY to the CHILD.

Also pay particular attention to the notes on rearward-facing or forward-facing child restraint systems on the front passenger seat (→ page 43).

Information on the automatic functions of the restraint system

Overview of the automatic measures after an accident

Depending on the type and severity of the accident, and depending on the vehicle's equipment, the following measures can be implemented, for example:

- automatic braking (post-collision brake)
- activating the hazard warning lights
- triggering an automatic emergency call (→ page 226)
- switching off the engine

To start the vehicle again, switch the vehicle off and on once more (→ page 111). Depending on the type and severity of the accident, it may be possible that the vehicle can no longer be started.
- switching off the fuel supply
- unlocking the vehicle doors
- lowering the front side windows
- switching on the interior lighting

Function of the post-collision brake after an accident

Function of the post-collision brake

Depending on the accident situation, the post-collision brake can minimize the severity of a further collision or even avoid it.

If an accident has been detected, the post-collision brake can implement automatic braking. When the vehicle has come to a standstill, the electric parking brake is automatically applied.

The driver can cancel automatic braking by taking the following actions:

- braking more strongly than automatic braking
- fully depressing the accelerator pedal with force

Purpose and function of the restraint system

Overview of deployment situations (restraint system)

Make sure that the following prerequisites in particular have been met, so that the components of the restraint system are able to provide the intended level of protection:

- Sit correctly (→ page 33).
- Fasten the seat belt correctly (→ page 34).
 - Function of the seat belt warning lamp (→ page 35) .
- The  restraint system warning lamp is not on after the self-test (→ page 35).

Depending on the detected deployment situation, the components of the restraint system can be activated or deployed independently of one another:

- Emergency Tensioning Device: frontal impact, rear impact, side impact¹⁾, overturning, rollover
- Driver's air bag, front passenger air bag: frontal impact
- Side air bag: side impact
- Window air bag: side impact, overturning, rollover, frontal impact

¹⁾ Only when the vehicle is installed with a side air bag or window air bag.

The installation location of an air bag is identified by the symbol AIRBAG (→ page 40).

Observe the information on the function of the restraint system (→ page 36).

Information on how the restraint system works

How the restraint system functions depends on the severity of the impact detected and the apparent type of accident.

For more information about types of accidents, see "Overview of deployment situations" (→ page 36).

The activation thresholds for the components of the restraint system are determined based on the evaluation of the sensor values measured at various points in the vehicle. This process is pre-emptive in nature. The triggering/deployment of the components of the restraint system must take place in good time at the start of the collision.

Factors that can be seen and measured only after a collision has occurred do not play a decisive role in the deployment of an air bag, nor do they provide an indication of air bag deployment.

The vehicle may be deformed significantly without an air bag being deployed. This is the case if only parts that are relatively easily deformed are affected and the rate of vehicle deceleration is not high. Conversely, an air bag may be deployed even though the vehicle suffers only minor deformation. If very rigid vehicle parts, such as longitudinal members, are hit, the vehicle deceleration may be high enough for this to happen.

Depending on the apparent type of accident and the detected deployment situation, Emergency Tensioning Devices and/or air bags supplement the protection offered by a correctly worn seat belt.

Vehicles with a front passenger bench seat: the Emergency Tensioning Device on the front passenger seat is triggered whether or not the seat belt tongue is engaged in the seat belt buckle.

When enabled, an air bag can provide additional protection for the respective vehicle occupant.

Possible protection per air bag:

- Driver's air bag, front passenger air bag: head and ribcage
- Window curtain air bag: head
- Side impact air bag: ribcage and pelvis

However, no system available today can completely eliminate injuries and fatalities in every accident situation. In particular, the seat belt and air bag generally do not protect against objects penetrating the vehicle from the outside. It is also not possible to completely rule out the risk of injury caused by the air bag deploying.

Mercedes-Benz recommends that you have the vehicle towed to a qualified specialist workshop after an accident. Take this into account, particularly if a Emergency Tensioning Device is triggered or an air bag deployed.

If the Emergency Tensioning Devices are triggered or an air bag is deployed, you will hear a bang, and a small amount of powder may also be released:

- The bang will not generally affect your hearing.
- In general, the powder released is not hazardous to health but may cause short-term breathing difficulties to persons suffering from asthma or other pulmonary conditions.

Provided it is safe to do so, leave the vehicle immediately or open the window in order to prevent breathing difficulties.

Air bags and pyrotechnic Emergency Tensioning Devices contain perchlorate material, which may require special handling or environmental protection measures. National guidelines regarding waste disposal must be observed. In California see <https://dtsc.ca.gov/>. You can use the search function to find information on perchlorate, for example.

Information on the limited protection provided by the restraint system

Risk due to the incorrect behavior of vehicle occupants

Every vehicle occupant must make sure of the following in particular:

- They observe the information on the correct seat position (→ page 33).
- There are no heavy, sharp-edged or fragile objects in the pockets of their clothing. Stow such objects in a suitable place.

⚠ WARNING Risk of injury or death due to an incorrect seat position

The seat belt does not offer the intended level of protection if you have not moved the seat backrest to an almost vertical position.

In particular, you could slip beneath the seat belt and become injured.

- ▶ Adjust the seat properly before beginning your journey.
- ▶ Always ensure that the seat backrest is in an almost vertical position and that the shoulder belt is routed across the center of your shoulder.

Risk due to objects in the vehicle interior

Every vehicle occupant must make sure of the following in particular:

- They observe the information on the correct seat position (→ page 33).
- There are no objects between the seat, door and door pillar (B-pillar).
- There are no hard objects, e.g. coat hangers, hanging on the grab handles or coat hooks.
- There are no heavy, sharp-edged or fragile objects in the pockets of your clothing. Store such objects in a suitable place.

⚠ WARNING Risk of injury or death due to blocked seat belt buckle or seat belt anchorage

Objects next to the front seat that block the seat belt buckle or the moving seat belt anchorage on the front seat impair the function of the Emergency Tensioning Devices.

- ▶ Before starting the journey, make sure that there are no objects around the seat belt buckle or between the front seat and door.

⚠ WARNING Risk of injury from objects in the deployment area of an airbag

Objects in the deployment area of an airbag can hinder or prevent the correct deployment of the airbag.

The airbag may then deploy in an uncontrolled manner and may even cause additional injuries to the vehicle occupants by deploying. This may be the case in particular if the airbag is integrated into the seat.

- ▶ Always stow and secure objects correctly.
- ▶ Before commencing your journey, make sure that no objects are stowed in the deployment area of an airbag.

The installation location of an air bag is identified by the AIRBAG symbol (→ page 40).

Risk due to installation of accessories

Do not attach accessories such as mobile navigation devices, mobile phones or cup holders within the deployment area of an air bag, e.g. on the cockpit, on the door, on the side window or on the side trim.

In addition, no connecting cables, tensioning straps or retaining straps may be routed or attached to the vehicle within the deployment area of an air bag. Always comply with the accessory manufacturer's installation instructions and, in particular, the notes on suitable places for installation.

⚠ WARNING Risk of injury or death due to unsuitable protective covers

Unsuitable protective covers mean that air bags can no longer protect vehicle occupants as they are designed to do.

- ▶ Use only protective covers approved by Mercedes-Benz for the seat in question.

Risk due to pets in the vehicle interior

⚠ WARNING Risk of accident and injury due to animals left unsecured or unattended in the vehicle

If you leave animals in the vehicle unattended or unsecured, they could possibly press buttons or switches.

An animal may:

- Activate vehicle equipment and become trapped, for example
- Switch systems on or off and endanger other road users

Unsecured animals may be thrown around in the vehicle in the event of an accident or sudden steering and braking maneuvers and injure vehicle occupants in the process.

- ▶ Never leave animals in the vehicle unattended.
- ▶ Always correctly secure animals while driving, e.g. using a suitable animal carrier.

Risk due to modification, damage or wear to the components of the restraint system

⚠ WARNING Risk of injury or death due to modifications to the restraint system

Vehicle occupants may no longer be protected as intended if alterations are made to the restraint system.

- ▶ Never alter the parts of the restraint system.
- ▶ Never tamper with the wiring or any electronic component parts or their software.

If it is necessary to adjust the vehicle to accommodate a person with physical disabilities, contact an authorized Mercedes-Benz Center for details.

USA only: for further information contact our Customer Assistance Center at 1-800-FOR-MERCEDES (1-800-367-6372).

⚠ WARNING Risk of injury or death due to damaged or modified seat belts

Seat belts cannot provide protection in the following situations:

- The seat belt is damaged, has been modified, is extremely dirty, bleached or dyed
- The seat belt buckle is damaged or extremely dirty
- Modifications have been made to the Emergency Tensioning Device, seat belt anchorage or seat belt retractor

Seat belts may sustain non-visible damage in an accident, e.g. due to glass splinters.

Modified or damaged seat belts could tear or fail in the event of an accident, for example.

Modified Emergency Tensioning Devices could accidentally trigger or fail to function as intended.

- ▶ Never modify the seat belt system, for example the seat belt, seat belt buckle, Emergency Tensioning Device, seat belt anchorage and seat belt retractor.
- ▶ Make sure that the seat belts are undamaged, not worn and clean.
- ▶ Always have the seat belts checked immediately after an accident at a qualified specialist workshop.

Only use seat belts which have been approved for your vehicle by Mercedes-Benz.

⚠ WARNING Risk of injury due to modifications to the cover of an airbag

If you change the cover of an airbag or attach objects, e.g. even stickers, to it, the airbag may no longer function as intended.

- ▶ Never modify the cover of an airbag.
- ▶ Do not attach any objects to the cover.

The installation location of an air bag is identified by the air bag symbol (→ page 40).

⚠ WARNING Risk of injury due to malfunctioning sensors in the door

The function of the airbags can be impaired due to modifications or incorrect work performed on the doors or door trim, or if the doors are damaged.

- ▶ Never modify the doors or parts of the doors.
- ▶ Always have work on the doors or door trim carried out at a qualified specialist workshop.

■ Risk due to components of the restraint system that have already been deployed

Mercedes-Benz recommends that you have the vehicle towed to a qualified specialist workshop after an accident.

⚠ WARNING Risk of burns from hot air bag components

The air bag parts are hot after an air bag has been deployed.

- ▶ Do not touch the air bag parts.
- ▶ Have a deployed air bag replaced at a qualified specialist workshop as soon as possible.

⚠ WARNING Risk of injury due to deployed airbag

A deployed airbag no longer offers any protection.

- ▶ Have the vehicle towed to a qualified specialist workshop in order to have the deployed airbag replaced.

Have deployed air bags replaced immediately.

⚠ WARNING Risk of injury or death from deployed pyrotechnic Emergency Tensioning Devices

Pyrotechnic Emergency Tensioning Devices that have been deployed are no longer operational and are unable to perform their intended protective function.

- ▶ Therefore, have deployed pyrotechnic Emergency Tensioning Devices immediately replaced at a qualified specialist workshop.

Seat belts

Unfastening the seat belts

- ▶ Press the release button on the seat belt buckle and guide the seat belt back with the seat belt tongue.

! **NOTE** Damage caused by trapping the seat belt

If an unused seat belt is not fully retracted, it may become trapped in the door or in the seat mechanism.

- ▶ Always ensure that an unused seat belt is fully retracted.

Airbags

Overview of air bags

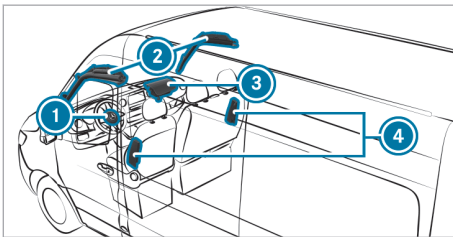

- ① Driver's air bag
- ② Window curtain air bag
- ③ Co-driver air bag
- ④ Side impact air bag

The installation location of an air bag is identified by the AIRBAG symbol.

Observe the information in "Overview of deployment situations" (→ page 36).

Brief overview of most important points

Safely transporting children in the vehicle

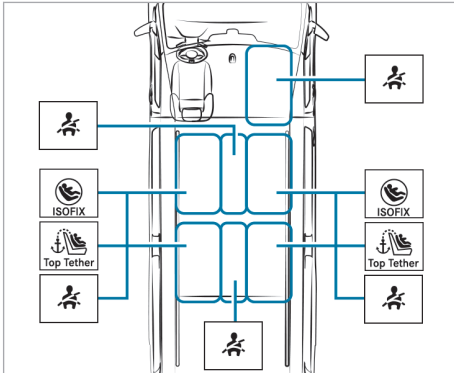

Always observe the following when carrying children:

- Never leave children unattended in the vehicle (→ page 42).
- Properly secure children up to a height of 5 m (1.50 m) or under 12 years of age on the appropriate seat with a suitable and approved child restraint system and secure infants in a rear-facing child restraint system.
- Observe the child restraint system manufacturer's installation instructions.

Left/right rear seat (preferred seats)



Preferred attachment system:

-  LATCH-type (ISOFIX) securing ring (→ page 45)

and

-  Also attach Top Tether if present (→ page 46).

Alternative attachment system:

-  Seat belt on vehicle seat (→ page 47)
-  Additionally attach Top Tether if recommended by the manufacturer of the child restraint system (→ page 46).



Front passenger seat

Attachment system:

-  Seat belt on vehicle seat (→ page 47)

Rear center seat

Attachment system:

-  Seat belt on vehicle seat (→ page 47)
-  Additionally attach Top Tether if recommended by the manufacturer of the child restraint system (→ page 46).

The following belt-secured child restraint systems within the Universal category are approved: U, UF. Take note (→ page 47).

Important safety notes

Basic information

Be diligent

Bear in mind that negligence when securing a child in the child restraint system can have serious consequences. Always be diligent and secure a child carefully before each journey.

Infants and children must never travel sitting on the lap of a vehicle occupant.

To improve protection for children under 12 years of age or less than 5 ft (1.50 m) in height, Mercedes-Benz recommends that you make sure you observe the following information:

- Always secure the child in a child restraint system suitable for this Mercedes-Benz vehicle.
- The child restraint system must be appropriate to the age, weight and size of the child.
- The vehicle seat must be suitable for the child restraint system to be installed:
 - ISOFIX mounting bracket (→ page 45)
 - Securing with the seat belt on the vehicle seat

Accident statistics show that children secured on the rear seats are generally safer than children secured on the front seats. For this reason, Mercedes-Benz strongly advises that you install a child restraint system on a rear seat if there are rear seats.

The generic term child restraint system

The generic term child restraint system is used in this Operator's Manual. A child restraint system can be e.g.:

- an infant carrier
- a rear-facing child seat

- a front-facing child seat
- a child booster seat – Mercedes-Benz recommends using a child booster seat **with** a seat backrest and seat belt guide

Observe laws and regulations

Always observe the legal requirements when using a child restraint system in the vehicle.

Securing systems for child restraint systems in the vehicle

Only use the following securing systems for child restraint systems:

- the ISOFIX/LATCH mounting bracket
- the seat belt system of the vehicle
- the Top Tether anchorages

Easy attachment to the ISOFIX/LATCH mounting bracket on the vehicle can reduce the risk of installing the child restraint system incorrectly.

When securing a child with the integrated seat belt of the ISOFIX child restraint system, always comply with the permissible total weight of the child and the child restraint system (→ page 45).

A booster seat may be necessary to achieve proper seat belt positioning for children over 40 lbs (18 kg) in weight or until they reach a height where a three-point seat belt can be installed properly without a booster seat.

Mercedes-Benz recommends a child booster seat with a backrest and seat belt guides.

Observe standards for child restraint systems

All child restraint systems must meet the following standards:

- U.S. Federal Motor Vehicle Safety Standards 213
- Canadian Motor Vehicle Safety Standards 213

Confirmation that the child restraint system complies with the standards can be found on an information label on the child restraint system. This confirmation can also be found in the installation instructions that are included with the child restraint system.

Important warning notices

Always secure a child restraint system correctly

⚠ WARNING Risk of injury or death due to incorrect installation of the child restraint system

The child can then not be protected or restrained as intended.

- ▶ Be sure to comply with the manufacturer's installation instructions for the child restraint system and its correct use.
- ▶ Make sure that the entire base of the child restraint system always rests on the sitting surface of the seat.
- ▶ Never place objects (e.g. cushions) under or behind the child restraint system.
- ▶ Use child restraint systems only with the original cover designed for them.
- ▶ Always replace damaged covers with genuine covers.

- Always observe the vehicle-specific information.
 - Installing the ISOFIX child restraint system on the rear seat (→ page 45).
 - Securing the child restraint system with the seat belt (→ page 47).
- Observe the warning labels in the vehicle interior and on the child restraint system.

⚠ WARNING Risk of injury or death due to unsecured child restraint systems in the vehicle

If the child restraint system is incorrectly mounted or unsecured, it may come loose.

The child can then not be protected or restrained as intended.

Unused child restraint systems could be flung around and hit vehicle occupants.

- ▶ Always comply with the manufacturer's installation instructions for the child restraint system and its correct use.
- ▶ Always fit child restraint systems correctly, even if they are transported in the vehicle unused.

Do not modify the child restraint system**⚠ WARNING** Risk of injury due to modifications to the child restraint system

The child restraint system can no longer function properly. This poses an increased risk of injury.

- ▶ Never modify a child restraint system.
- ▶ Only affix accessories which have been specially approved for this child restraint system by the child restraint system's manufacturer.

Only use child restraint systems which are in proper working condition**⚠ WARNING** Risk of injury or death caused by the use of damaged child restraint systems

Child restraint systems or their retaining systems that have been subjected to stress in an accident may not be able to perform their intended protective function.

It may be the case that the child cannot be properly restrained.

- ▶ Always immediately replace child restraint systems that have been damaged or involved in an accident.
- ▶ Have the securing systems for the child restraint systems checked at a qualified specialist workshop before installing a child restraint system again.

Avoid direct sunlight**⚠ WARNING** Risk of burns when the child seat is exposed to direct sunlight

If the child restraint system is exposed to direct sunlight or heat, parts could heat up excessively.

Children could suffer burns from these parts, particularly the metallic parts of the child restraint system.

- ▶ Always make sure that the child restraint system is not exposed to direct sunlight.
- ▶ Cover the child restraint system with a blanket, for example.
- ▶ If the child restraint system has been exposed to direct sunlight, allow it to cool before securing a child into it.

- ▶ Never leave children unattended in the vehicle.

Observe when stopping or parking**⚠ WARNING** Risk of fatal injury due to exposure to extreme heat or cold in the vehicle

If persons, particularly children, are subjected to prolonged exposure to intense heat or cold, there is a risk of severe injury or even death.

- ▶ Never leave persons, particularly children, unattended in the vehicle.

⚠ WARNING Risk of accident and injury due to children left unattended in the vehicle

If you leave children unattended in the vehicle, they could, in particular:

- open doors, thereby endangering other persons or road users.
- get out and be struck by oncoming traffic.
- operate vehicle equipment and become trapped, for example.

In addition, the children could also set the vehicle in motion by, for example:

- releasing the parking brake.
- changing the gearbox position.
- starting the vehicle.

- ▶ Never leave children unattended in the vehicle.
- ▶ When leaving the vehicle, always take the key with you and lock the vehicle.
- ▶ Keep the key out of reach of children.

Notes on rearward-facing child restraint systems on the front passenger seat

The front passenger air bag cannot be deactivated. Never install a rearward-facing child restraint system on the front passenger seat. Observe the manufacturer's installation and operating instructions for the child restraint system.

Securing the child restraint system

Adjusting the seat correctly

When installing a child restraint system on the left or right-hand rear seat, always observe the following:

- ▶ Make sure that the child's feet do not touch the front seat. If necessary, move the front seat slightly forward.

If the head restraint of the child restraint system cannot be completely extended when installed, the maximum size adjustment for certain child restraint systems may be restricted. Observe the installation instructions of the child restraint system's manufacturer in this respect.

- ⓘ Contact with the roof when the head restraint is fully extended and locked in place will not result in any restrictions on use.

 **When installing an ISOFIX/LATCH child restraint system, also observe the following:**

- ▶ **When using a rear-facing child restraint system on a rear seat:** adjust the front seat in such a way as to ensure that it is not touching the child restraint system.
- ▶ **When using a front-facing child restraint system with integrated child seat belt:** adjust the head restraint of the respective seat so that it cannot push the child restraint system forward. If necessary, the corresponding head restraint can be removed. In addition, the seat backrest of the child restraint system must lie as flat as possible against the backrest of the vehicle seat. After the child restraint system has been removed, immediately replace the vehicle head restraint and adjust correctly.
- ▶ Do not wedge the child restraint system between the roof and the seat surface and/or install it facing in the wrong direction. Where possible, adjust the seat cushion inclination accordingly.
- ▶ Adjust the vehicle head restraints so that the child restraint system is not put under strain by the head restraint.

 **When installing a belt-secured child restraint system, also observe:**

- ▶ **When using a rear-facing child restraint system on a rear seat:** adjust the front seat in such a way as to ensure that it is not touching the child restraint system.
- ▶ Also attach Top Tether if present .

- ▶ **When using a front-facing child restraint system with integrated child seat belt:** adjust the head restraint of the respective seat so that it cannot push the child restraint system forward. If necessary, the corresponding head restraint can be removed. In addition, the seat backrest of the child restraint system must lie as flat as possible against the backrest of the vehicle seat. After the child restraint system has been removed, immediately replace the vehicle head restraint and adjust correctly.

- ▶ Ensure that the seat backrest of front-facing child restraint system is lying as flat as possible against the backrest of the rear seat.
- ▶ Do not wedge the child restraint system between the roof and the seat surface and/or install it facing in the wrong direction. Where possible, adjust the seat cushion inclination accordingly.
- ▶ Adjust the vehicle head restraints so that the child restraint system is not put under strain by the head restraint.
- ▶ Make sure that the child's feet do not touch the front seat. If necessary, move the front seat slightly forward.

 **Depending on the vehicle equipment, always observe the following when installing a belt-secured child restraint system on the front passenger seat:**

- ▶ **When using a front-facing child restraint system with integrated child seat belt:** remove the head restraint from the respective seat, if possible. After the child restraint system has been removed, immediately replace the head restraint and adjust correctly.
- ▶ The backrest of the front-facing child restraint system must, as far as possible, be resting against the seat backrest of the front passenger seat.
- ▶ Do not wedge the child restraint system between the roof and the seat surface and/or install it facing in the wrong direction.
- ▶ Adjust the vehicle head restraints so that the child restraint system is not put under strain by the head restraint.
- ▶ Never place objects (e.g. cushions) under or behind the child restraint system.
- ▶ Set the front passenger seat as far back as possible and move the seat into the highest position possible. Always make sure that the shoulder belt strap is correctly routed from the

seat belt outlet of the vehicle to the shoulder belt guide on the child restraint system. The shoulder belt strap must be routed forwards from the seat belt outlet and, where possible, downwards to the child restraint system.

- ▶ Fully retract the seat cushion length adjustment.
- ▶ Set the seat cushion inclination in such a way that the front edge of the seat cushion is in the highest position and the rear edge of the seat cushion is in the lowest position.
- ▶ Set the seat backrest to the most vertical position possible.

Activating or deactivating the child seat safety feature of the seat belt

⚠ WARNING Risk of injury or death if a seat belt is unfastened while the vehicle is in motion

If the seat belt is released while the vehicle is in motion, the special seat belt retractor is deactivated and the child restraint system is no longer correctly secured. The seat belt is drawn in slightly by the inertia reel and cannot be immediately closed again.

- ▶ Stop the vehicle immediately in accordance with the traffic conditions.
- ▶ Activate the special seat belt retractor again and correctly secure the child restraint system.

When activated, the child seat safety feature ensures that the seat belts of the front passenger seat do not slacken once the child restraint system is secured.

The seat belts on the following seats are equipped with a child seat safety feature:

- Front passenger seat
- Rear seats

Installing a child restraint system

- ▶ When installing a child restraint system, always observe the manufacturer's installation and operating instructions for the child restraint system used, as well as the notes in this Operator's Manual.
- ▶ Pull the seat belt smoothly from the seat belt outlet.
- ▶ Engage the seat belt tongue in the seat belt buckle.

Activating the child seat safety feature

- ▶ Extend the seat belt fully and then allow the inertia reel to retract the belt. When the child seat safety feature is activated, you should hear a ratcheting sound.
- ▶ Push the child restraint system down until the seat belt is tight.

Deactivating the child seat safety feature

- ▶ Press the release button of the seat belt buckle.
- ▶ Hold the seat belt tongue and guide it back to the seat belt outlet.

Installing an ISOFIX/LATCH child restraint system on the rear seat

⚠ WARNING Risk of injury or death if the permissible gross mass of the child and child restraint system together is exceeded.

Too much load may be placed on the LATCH-type (ISOFIX) or iSize child restraint systems and the child may not be restrained correctly in the event of an accident, for example.

- ▶ If the child is secured in a LATCH-type (ISOFIX) child restraint system with integrated seat belt, the total mass of the child and child restraint system must not exceed 73 lb (33 kg).

Always observe the information about the mass of the child:

- In the manufacturer's installation and operating instructions for the child restraint system used
- On a label on the child restraint system, if available

Regularly check that the permissible gross mass of the child and child restraint system is still complied with.

When you install a child restraint system, observe the following:

- Always observe the correct use and suitability of the seats for attaching a child restraint system.
ISOFIX/LATCH child seat anchor
- Always observe the manufacturer's installation and operating instructions for the child restraint system used.

- ✔ Make sure that the child's feet do not touch the front seat. If necessary, move the front seat slightly forward.
- 🔗 When installing an ISOFIX/LATCH child restraint system, also observe the following:
 - ✔ **When using a weight category 0/0+ baby car seat and a weight category I rearward-facing child restraint system on a rear seat:** adjust the rear and/or front seat so that the front seat does not touch the child restraint system.
 - ✔ **When using a weight category I forward-facing child restraint system:** the backrest of the child restraint system must, as far as possible, lie flat against the backrest of the seat.
 - ✔ For certain child restraint systems in weight category II or III, there may be restrictions on the maximum size setting, e.g. owing to possible contact with the roof.
 - ✔ Do not wedge the child restraint system between the roof and the seat surface and/or install it facing the wrong direction.
 - ✔ Do not put the child restraint system under load from the head restraint. Adjust the head restraints as appropriate.

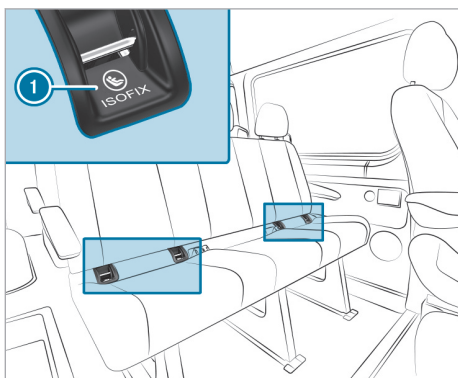

1 LATCH-type (ISOFIX) securing ring

Before every journey, make sure that the ISOFIX/LATCH child restraint system is engaged correctly in both securing rings in the vehicle.

! **NOTE** Damage to the seat belt for the center seat during installation of the child restraint system

▶ Make sure that the seat belt is not trapped.

- ▶ Attach the ISOFIX/LATCH child restraint system to both securing rings 1 in the vehicle.

Securing Top Tether

⚠ WARNING Risk of injury due to incorrect attachment of the Top Tether belt

If you attach the Top Tether belt incorrectly, the child restraint system is not properly secured and therefore cannot protect as intended.

- ▶ Attach the Top Tether hook only to the intended Top Tether anchorage.

- 🔗 If the child restraint system is equipped with a Top Tether belt:

The risk of injury can be reduced by Top Tether. The Top Tether belt enables an additional connection between the child restraint system attached with ISOFIX and the vehicle.

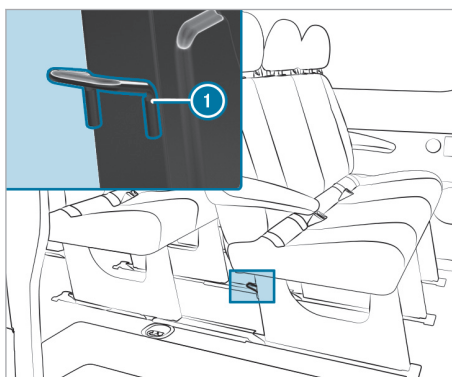

Top Tether anchorages 1 are located on the back of the rear bench seat on the bench seat legs.

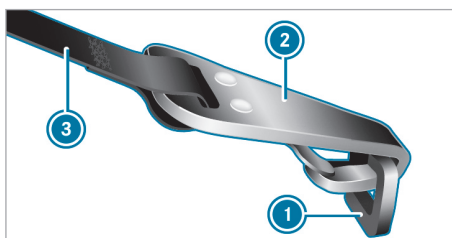

- ▶ If necessary, move the head restraint upwards (→ page 79).

- ▶ Install the ISOFIX/LATCH child restraint system with Top Tether. Comply with the child restraint system manufacturer's installation instructions.
- ▶ Guide Top Tether belt ③ under the head restraint between the two head restraint bars.
- ▶ Hook Top Tether hook ② into Top Tether anchorage ① without twisting.
- ▶ Tension Top Tether belt ③. Comply with the child restraint system manufacturer's installation instructions.
- ▶ If necessary, slide the head restraint downwards (→ page 79). Make sure that you do not interfere with the correct routing of Top Tether belt ③.

Securing the child restraint system with the seat belt

The seat belts on the following seats are equipped with a child seat safety feature:

- Front passenger seat
- Rear seats

When enabled, the child seat safety feature ensures that the seat belts of the front passenger seat do not slacken once the child restraint system is secured.

- ▶ Install the child restraint system. The entire base of the child restraint system must always rest on the sitting surface of the seat.
- ▶ Always make sure that the shoulder belt strap is correctly routed from the seat belt outlet of the vehicle to the shoulder belt guide on the child restraint system. The shoulder belt strap must be routed forwards from the seat belt outlet and, where possible, downwards to the child restraint system.
- ▶ If necessary, adjust the seat belt outlet and the front passenger seat as appropriate.

Child safety locks

Activating or deactivating child safety locks for the sliding doors

⚠ WARNING Risk of accident and injury due to children left unattended in the vehicle

If you leave children unattended in the vehicle, they could, in particular:

- open doors, thereby endangering other persons or road users.
- get out and be struck by oncoming traffic.
- operate vehicle equipment and become trapped, for example.

In addition, the children could also set the vehicle in motion by, for example:

- releasing the parking brake.
- changing the gearbox position.
- starting the vehicle.

- ▶ Never leave children unattended in the vehicle.
- ▶ When leaving the vehicle, always take the key with you and lock the vehicle.
- ▶ Keep the key out of reach of children.

⚠ WARNING Risk of fatal injury due to exposure to extreme heat or cold in the vehicle

If persons, particularly children, are subjected to prolonged exposure to intense heat or cold, there is a risk of severe injury or even death.

- ▶ Never leave persons, particularly children, unattended in the vehicle.

⚠ WARNING Risk of accident and injury due to children left unattended in the vehicle

If children are traveling in the vehicle, they could, in particular:

- Open doors, thereby endangering other persons or road users
- Get out and be struck by oncoming traffic
- Operate vehicle equipment and become trapped, for example

- ▶ Always activate the child safety locks installed if children are traveling in the vehicle.

- ▶ Never leave children unattended in the vehicle.
- ▶ When leaving the vehicle, always take the SmartKey with you and lock the vehicle.

The following doors have child safety locks:

- Sliding doors

The child safety locks on the doors secure each door separately. The doors can no longer be opened from the inside (except the electric sliding door). The door can be opened from the outside when the vehicle is unlocked.

The electric sliding door can be opened at any time using the button on the center console.

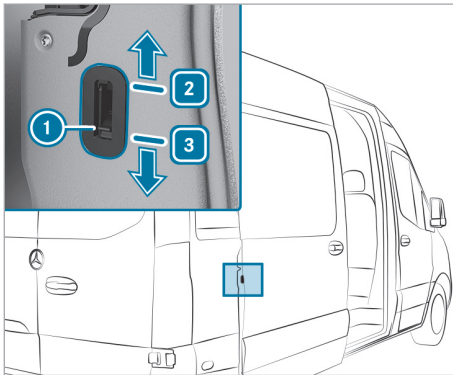

Example: sliding door child safety lock

- ▶ Slide the child safety lock latch ① into position ② (locked) or ③ (unlocked).
- ▶ Ensure that the child safety locks are working properly.

SmartKey

Notes on radio connections of the key

⚠ DANGER Risk of fatal injury to persons with medical devices due to electromagnetic radiation when using the start/stop button

Persons with medical devices, e.g. pacemakers or defibrillators:

There is a radio connection between the key and the vehicle.

The function of a medical device can be impaired.

- ▶ Before operating the vehicle, consult your doctor or the manufacturer of the medical device about any possible effects from such systems.

Detection range of the KEYLESS-START function antenna

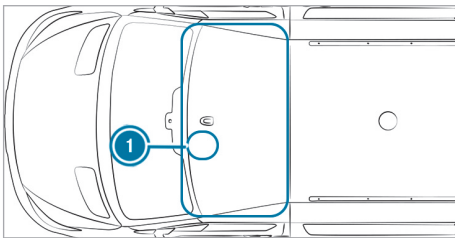

- ① Position of the key holder when the detection range of the antenna is reduced

Overview of SmartKey functions

⚠ WARNING Risk of accident and injury due to children left unattended in the vehicle

If you leave children unattended in the vehicle, they could, in particular:

- open doors, thereby endangering other persons or road users.
- get out and be struck by oncoming traffic.
- operate vehicle equipment and become trapped, for example.

In addition, the children could also set the vehicle in motion by, for example:

- releasing the parking brake.
 - changing the gearbox position.
 - starting the vehicle.
- ▶ Never leave children unattended in the vehicle.
 - ▶ When leaving the vehicle, always take the key with you and lock the vehicle.
 - ▶ Keep the key out of reach of children.

! **NOTE** Damage to the SmartKey caused by magnetic fields

- ▶ Keep the SmartKey away from strong magnetic fields.

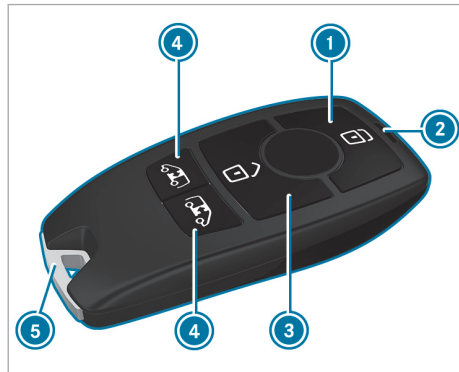



- ① To lock
- ② Battery indicator light
- ③ To unlock
- ④ To unlock the cargo compartment (sliding doors and rear-end doors)/to unlock and open/close the electric sliding doors
- ⑤ Emergency key

The SmartKey's factory setting enables you to centrally lock and unlock the following components:

- The driver's and front passenger door
- The sliding doors
- The rear-end doors

- ① If you do not open the vehicle within approximately 40 seconds of unlocking it, the vehicle will lock again and anti-theft protection will be armed again.

Do not keep the SmartKey together with electronic devices or metallic objects. This can affect the SmartKey's functionality.

- ❗ If the indicator lamp does not light up when you press the  or  button, the battery is discharged.

Replace the SmartKey battery (→ page 50).

Activating/deactivating the acoustic locking verification signal



Multimedia system:

  **Settings**  **Vehicle**

- ▶ Activate or deactivate **Acoustic Lock**.

Changing the unlocking settings



The key has the following adjustable unlocking functions:

- unlock the vehicle centrally
 - unlock the driver's door (vehicles without partition or with cab)
 - unlock the driver's door and front passenger door (vehicles with partition)
- ▶ **To switch between settings:** press and hold the  and  buttons at the same time for approximately six seconds until the indicator lamp flashes twice.
 - ▶ **To unlock the vehicle centrally when the unlocking function is selected for the driver's door or the driver's and front passenger door:** press the  button a second time.

Reducing the energy consumption of the SmartKey

Deactivating SmartKey function

If you do not use the vehicle or a SmartKey for an extended period of time, you can also deactivate the function of the SmartKey to reduce its energy consumption.

- ▶ Press and hold the  button on the SmartKey.
- ▶ With the  button held down, immediately press the  button on the SmartKey twice in quick succession.
The SmartKey's indicator light will light up once briefly and once for a long time.

Deactivating SmartKey function



- ▶ Press any button on the SmartKey.

- ❗ The SmartKey function will automatically be activated when the vehicle is started with the SmartKey in the gearshift console slot (→ page 112).

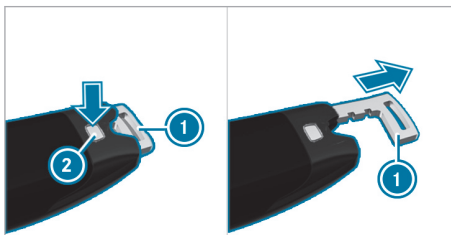

Removing and inserting the mechanical key

Removing



- ▶ Press release button .
Emergency key  is pushed slightly out.
- ▶ Pull mechanical key  out completely.

Inserting

- ▶ Press release button .
- ▶ Slide the mechanical key  in completely until it engages.

Replacing the key battery

⚠ DANGER Risk of fatal injury due to swallowing batteries

Batteries contain toxic and corrosive substances. If batteries are swallowed or otherwise enter the body, severe internal burns can occur within two hours.

There is a risk of fatal injury!

- ▶ Keep the batteries out of the reach of children.
- ▶ If the lid and/or the battery compartment do not close securely, stop using the key and keep it away from children.
- ▶ If batteries are swallowed or otherwise enter the body, seek immediate medical attention.

 **ENVIRONMENTAL NOTE** Environmental damage due to improper disposal of batteries



Batteries contain pollutants. It is illegal to dispose of them with the household rubbish.



Dispose of batteries in an environmentally responsible manner. Take discharged batteries to a qualified specialist workshop or to a collection point for used batteries.

Requirements:

- One CR 2032 3 V cell battery

Mercedes-Benz recommends that you have the battery replaced by a qualified specialist workshop.

- ▶ Removing the emergency key (→ page 50).



Example image

- ▶ Press release button (2) down fully and slide cover (1) forward.
- ▶ Remove battery compartment (3) and remove the discharged battery.
- ▶ Insert the new battery into battery compartment (3). Observe the positive pole marking in the battery compartment and on the battery.
- ▶ Insert battery compartment (3).
- ▶ Replace cover (1) so that it engages.
- ▶ Slide the emergency key in completely until it engages (→ page 50).

Rectifying problems with the key

You can no longer lock or unlock the vehicle

Possible causes:

- The key battery is weak or discharged.
- There is interference from a powerful radio signal source.
- The key is faulty.

- ▶ Check the battery with the indicator lamp and replace if necessary (→ page 50).
- ▶ Use the mechanical key to unlock and lock the vehicle (→ page 50).
- ▶ Have the key checked at a qualified specialist workshop.

You have lost a key

- ▶ Have the key deactivated at a qualified specialist workshop.
- ▶ If necessary, have the mechanical locks replaced.

Doors

Unlocking and opening the door from inside

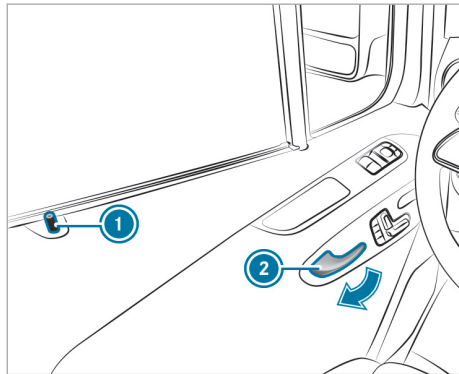

- ▶ **To unlock and open the front door:** pull door handle (2). Safety pin (1) pops up when the door is unlocked.

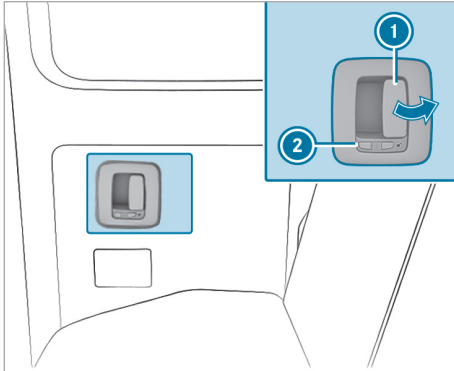

The  symbol indicates that the rear door is unlocked.

▶ **To unlock and open the rear door:** pull opening lever ① and open the rear door. When the door unlocks, latch ② moves forward.

The  symbol is visible.

▶ **To close:** pull the rear door closed by the door handle.

▶ **To lock:** slide latch ② back. The  symbol is visible.

Centrally locking and unlocking the door from the inside

⚠ WARNING Risk of accident and injury due to children left unattended in the vehicle

If you leave children unattended in the vehicle, they could, in particular:

- open doors, thereby endangering other persons or road users.
- get out and be struck by oncoming traffic.
- operate vehicle equipment and become trapped, for example.

In addition, the children could also set the vehicle in motion by, for example:

- releasing the parking brake.
- changing the gearbox position.
- starting the vehicle.

- ▶ Never leave children unattended in the vehicle.
- ▶ When leaving the vehicle, always take the key with you and lock the vehicle.

▶ Keep the key out of reach of children.

⚠ WARNING Risk of fatal injury due to exposure to extreme heat or cold in the vehicle

If persons, particularly children, are subjected to prolonged exposure to intense heat or cold, there is a risk of severe injury or even death.

▶ Never leave persons, particularly children, unattended in the vehicle.

You can use the central locking buttons to centrally lock and unlock the entire vehicle from the inside.

The central locking buttons are located in the driver's and front passenger door.

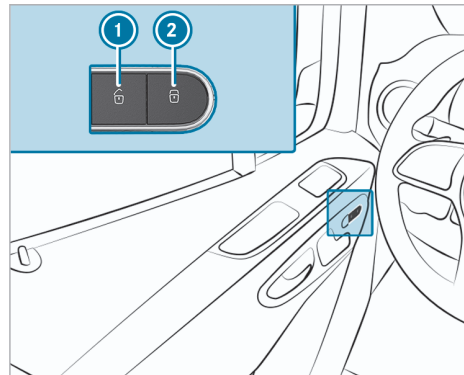

Central locking buttons (vehicles with electrically adjustable front seats)

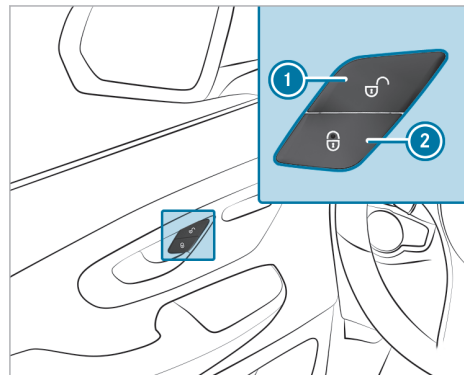

Central locking buttons (vehicles with manually adjustable front seats)

- ▶ **To unlock:** with the doors closed, press button ①.
- ▶ **To lock:** with the doors closed, press button ②.

Activating/deactivating the automatic locking mechanism

Requirements:

- The power supply of the vehicle has been switched on.
- The doors are closed.

When the automatic locking mechanism is activated and the vehicle is traveling at a speed above 9 mph (15 km/h), the vehicle is locked automatically.

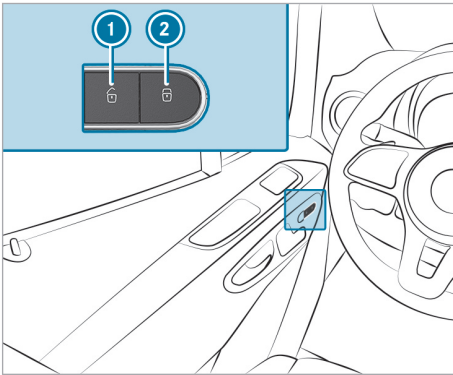

Central locking buttons (vehicles with electrically adjustable front seats)

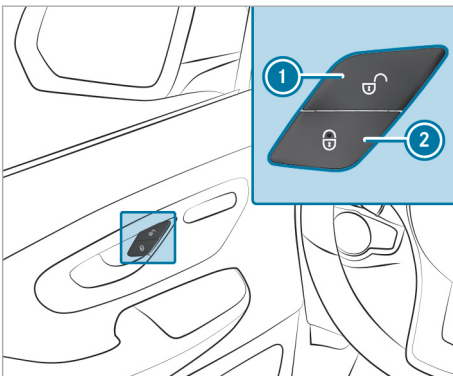

Central locking buttons (vehicles with manually adjustable front seats)

If the vehicle is being tow-started, push-started or tested on a roller dynamometer, there is a risk of being locked out when the function is activated.

- ▶ **To activate:** press and hold button ② until you hear a tone.
- ▶ **To deactivate:** press and hold button ① until you hear a tone.

Automatic locking after closing the last door

▲ WARNING Risk of fatal injury due to exposure to extreme heat or cold in the vehicle

If persons, particularly children, are subjected to prolonged exposure to intense heat or cold, there is a risk of severe injury or even death.

- ▶ Never leave persons, particularly children, unattended in the vehicle.

▲ WARNING Risk of accident and injury due to children left unattended in the vehicle

If you leave children unattended in the vehicle, they could, in particular:

- open doors, thereby endangering other persons or road users.
- get out and be struck by oncoming traffic.
- operate vehicle equipment and become trapped, for example.

In addition, the children could also set the vehicle in motion by, for example:

- releasing the parking brake.
- changing the gearbox position.
- starting the vehicle.

▶ Never leave children unattended in the vehicle.

▶ When leaving the vehicle, always take the key with you and lock the vehicle.

▶ Keep the key out of reach of children.

▲ WARNING Accident- and risk of injury with unsecured or unattended animals in parked vehicle

If you leave animals in the vehicle unattended or unsecured, they could possibly press buttons or switches.

An animal may:

- Activate vehicle equipment and become trapped, for example.
 - Switch systems on or off and endanger other road users
- ▶ Never leave animals in the vehicle unattended.
- ▶ Always secure animals properly, e.g. with a suitable animal transport box.

After leaving the vehicle and closing the last door, the vehicle is automatically locked. This also applies if the SmartKey is still in the vehicle.

There is a danger of locking oneself out. The vehicle can only be opened again with a SmartKey for the vehicle.

- Always carry the SmartKey for the vehicle with you when leaving the vehicle.
- ❗ If the vehicle is locked and the only available SmartKey is in the vehicle, notify a qualified specialist workshop.



Warning notice, depending on the equipment on the driver's door, the partition wall, the sliding door or the Speed Delivery Door

Unlocking and locking the driver's door with the mechanical key

- ❗ If you want to lock the vehicle completely with the mechanical key, press the button for the locking mechanism from inside first with the driver's door open. Then lock the driver's door with the mechanical key.

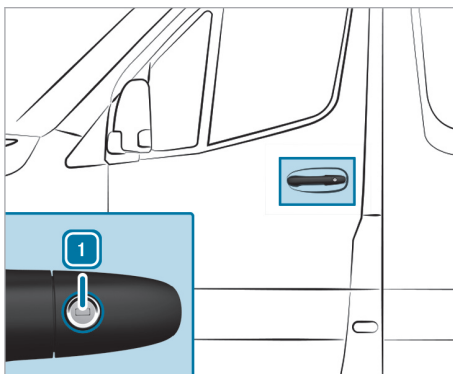

▶ **To unlock:** turn the mechanical key counter-clockwise to position **1**.

▶ **To lock:** turn the mechanical key clockwise to position **1**.

❗ **Right-hand drive vehicles:** turn the mechanical key in the opposite direction for each case.

Using the grab handles when getting into and out of the vehicle

The entrances may be equipped with grab handles and steps. The grab handles to enter and exit the vehicle are at the front door and the sliding door.

❗ To avoid risks:

- When getting into and out of the vehicle, always use the grab handles and steps. These are specifically designed to withstand such loads.
- Keep steps and entrances free from dirt, e.g. mud, clay, snow and ice.

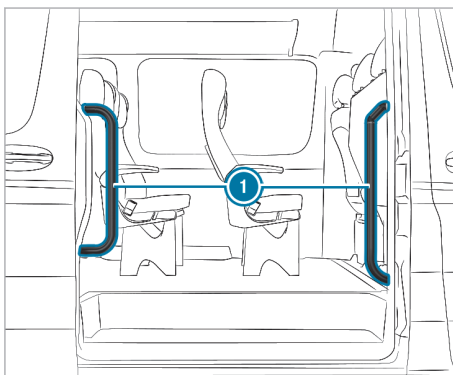

Getting into and out of the vehicle (example: sliding door)

- ▶ When getting into and out of the vehicle, use the grab handles ❶ and steps.
- ❶ The grab handles on the sliding door are provided as an easy entry and exit feature and can hold up to a maximum of 176 lbs (80 kg). Do not use the grab handle on the sliding door to secure a load (lashing). Do not secure any objects to the easy entry and exit features.

Sliding door

Opening and closing the sliding door

⚠ WARNING Risk of becoming trapped due to an open sliding door which is not engaged in place

On an incline, the sliding door can move by itself.

This can cause you or other people to become trapped.

- ▶ Always make sure that the open sliding door is engaged. To do so, open the sliding door to the stop.

⚠ WARNING Risk of becoming trapped due to sliding door opening towards the rear

When you open the sliding door, the sliding door could hit other people as it moves towards the rear of the vehicle.

- ▶ Only open the sliding door when traffic conditions permit.

To unlock

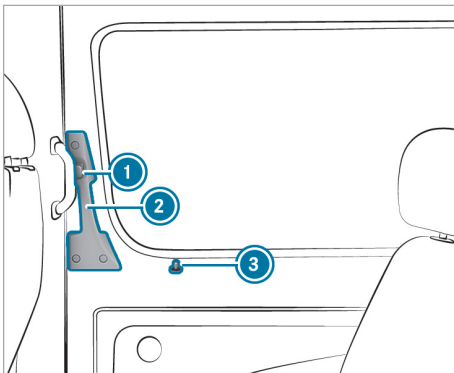

- ▶ Pull safety pin ❸ upwards manually or use the central locking button to unlock the sliding door (→ page 52).

Opening

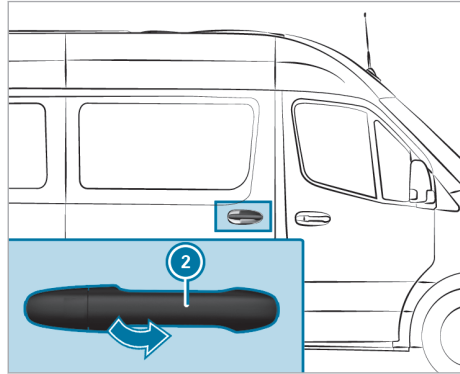

- ❶ Your vehicle may be equipped with a long sliding door with an intermediate catch. You can also lock the sliding door in place around half-way when opening and closing. This means you do not always have to open the door fully when getting in or out. The sliding door is not fully engaged when in the intermediate catch position.

- ▶ Press in the button ❶ and pull the door ❷ handle.
- ▶ Push back the sliding door fully using the door handle ❷ until it engages.
- ▶ Check the sliding door catch.

Closing

- ▶ Press in the button ❶ and pull the door ❷ handle.
- ▶ Slide the sliding door firmly forwards using the door handle ❷ until it closes.

To lock

- ▶ Push safety pin ❸ downwards manually or use the central locking button to lock the sliding door (→ page 52).

Notes on electrical closing assist

If your vehicle is fitted with electrical closing assist, you will require less force to close the sliding door.

Electric sliding door

Function of the electric sliding door

Your vehicle may be equipped with an electric sliding door on the left and/or right-hand side.

You can operate the electric sliding door in the following ways:

- by pressing the sliding door buttons on the center console
- by pressing the sliding door button on the door sill (B-pillar)
- using the door handle (inside or outside)
- using the key

If the electric sliding door is obstructed while opening, it will move a few centimeters in the opposite direction and then stop.

If the sliding door is obstructed during the closing procedure, it will open fully again.

If the electric motor of the sliding door is in danger of overheating, e.g. due to frequent opening and closing within a short period, the sliding door will open fully. The sliding door will then be locked in place. The sliding door will be operational again after approximately 30 seconds.

If there has been a malfunction or the battery has been disconnected, you can use the release catch to disconnect the sliding door from the electric motor. You will then be able to open or close the door manually (→ page 57).

Opening/closing the electric sliding door with the button

⚠ WARNING Risk of becoming trapped due to sliding door opening towards the rear

When you open the sliding door, the sliding door could hit other people as it moves towards the rear of the vehicle.

- ▶ Only open the sliding door when traffic conditions permit.

⚠ WARNING Risk of injury despite the object detection function

The object detection function does not react to soft, light and thin objects, such as fingers. The object detection function cannot prevent someone from becoming trapped in these situations.

- ▶ When opening and closing the electric sliding door, make sure that no parts of the body are within the operating range of the sliding door.
- ▶ If someone becomes trapped, press the button again to stop the sliding door.

Object detection:

If an object obstructs the sliding door as it closes, the sliding door will be stopped. Object detection is only an aid. It is not a substitute for your attentiveness.

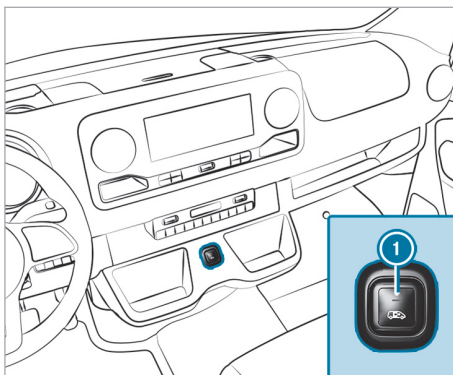

- ① Opens and closes the sliding door on the right side of the vehicle

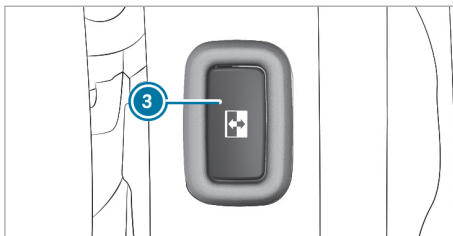

In vehicles with a partition, button ③ is located on the partition next to the door entrance at the height of the inside door handle.

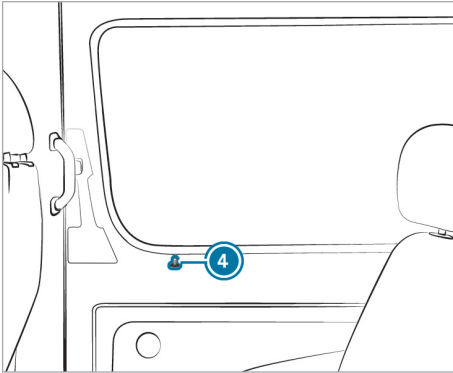









When the sliding door is locked, it can only be opened from the inside by manually unlocking locking pin ④.

- ▶ **To unlock:** pull locking pin ④ up manually or use the central locking button to unlock the sliding door (→ page 52).
- ▶ **To open:** briefly press button ①, ② or ③. The sliding door will open automatically. When you open the door using button ① or ②, you will hear two acoustic signals. The indicator lamp at the top of button ① or ② will flash, and button ③ will flash. When the sliding door is completely open, the indicator lamp at the top of button ① or ② will light up.
- ▶ **To close:** briefly press button ①, ② or ③. The sliding door will close automatically. When you close the door using button ① or ②, you will also hear two acoustic signals. The indicator lamp at the top of button ① or ② will flash, and button ③ will flash. When the sliding door is completely closed, the indicator lamp at the top of button ① or ② will go out.
- ▶ **To stop automatic operation:** briefly press button ① or ②. The sliding door will stop moving.
- ▶ **To lock:** push the locking pin ④ down manually or use the central locking button to lock the sliding door (→ page 52).

- ① When you stop automatic operation during opening, the door will close when you press the button again.

- ① In unfavorable operating conditions, e.g. frost or ice, or if the vehicle is very dirty, you can press and hold the corresponding button. The electric sliding door will then move with increased force. Note that, in such circumstances, the object detection function is less sensitive. To stop the movement, release the button.

Opening/closing the electric sliding door with the key

- ▶ **To unlock:** briefly press the  or  button on the key.
- ▶ **To open:** press and hold the  or  button on the key for longer than 0.5 seconds. You will hear two acoustic signals and the sliding door will open automatically.
- ▶ **To close:** press and hold the  or  button on the key for longer than 0.5 seconds. You will hear two acoustic signals and the sliding door will close automatically.
- ▶ **To interrupt automatic operation:** briefly press the  or  button on the key. The sliding door stops moving.

- ① When you stop automatic operation upon opening the door, the door closes when you press the button again.

Opening/closing the electric sliding door with the door handle

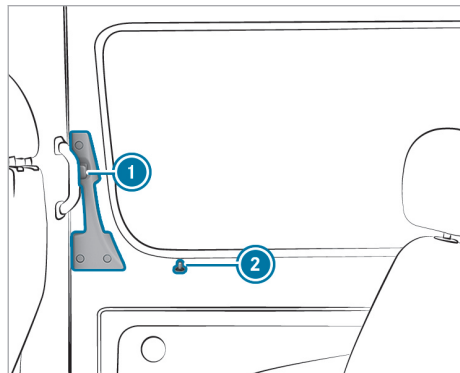

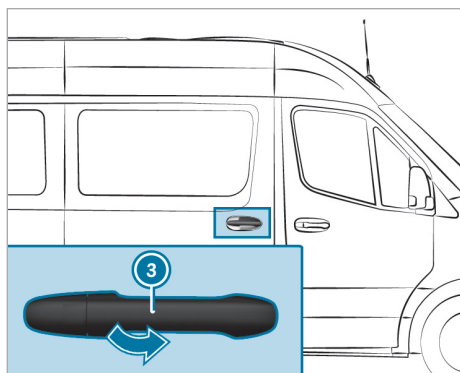

- ▶ **To unlock:** pull locking pin ② up manually or use the central locking button to unlock the sliding door (→ page 52).
- ▶ Press button ① or pull outside door handle ③.
The sliding door will open or close.
- ▶ Press button ① again or pull outside door handle ③.
The sliding door will stop moving.

Unlocking the electric sliding door manually

Disconnecting the sliding door from the electric motor

- ▶ Insert the emergency key into opening ① of disconnect switch ② in the "AUTO" position.
- ▶ Turn the emergency key 180° clockwise.
The "MAN" position will be set.
- ▶ Open or close the sliding door with the outside or inside door handle.

Establishing the connection between the sliding door and electric motor

- ▶ Insert the emergency key into opening ① of disconnect switch ② in the "MAN" position.
- ▶ Turn the emergency key 180° counter-clockwise.
The "AUTO" position will be set.
- ▶ Adjust the sliding door (→ page 59).

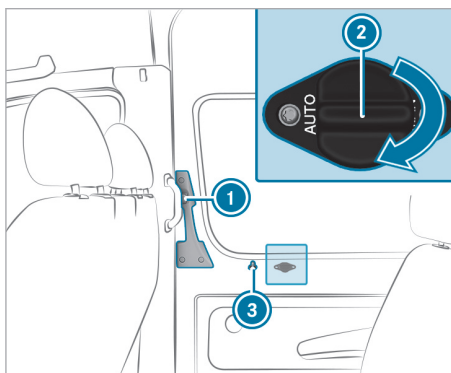

If there has been a malfunction or if the battery has been disconnected, you can use disconnect switch ② to disconnect the sliding door from the electric motor. Then you can open or close the sliding door manually.

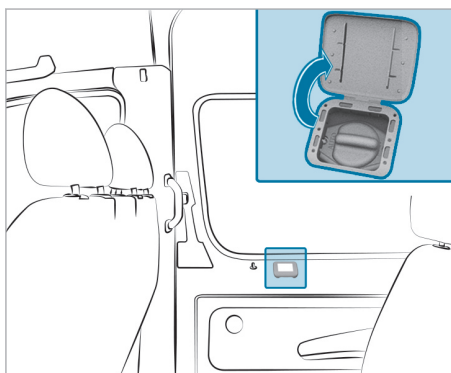

Cover in sliding door trim

- ▶ **Vehicles with sliding door trim:** fold the cover of disconnect switch ② up.
The disconnect switch will be accessible.
- ▶ **To disconnect the sliding door from the electric motor:** turn disconnect switch ② 180° clockwise.
The "MAN" position will be set.

Unlocking

- ▶ Pull locking pin ③ up manually or use the central locking button to unlock the sliding door (→ page 52).
- ▶ Press release button ①.
- ▶ Open or close the sliding door with the outside or inside door handle.

Establishing the connection between the sliding door and electric motor

- ▶ Turn disconnect switch ② 180° counter-clockwise.
The "AUTO" position will be set.
- ▶ Adjust the sliding door (→ page 59).
- ▶ If it is not possible to rectify the malfunction, visit a qualified specialist workshop.

Resetting the electric sliding door

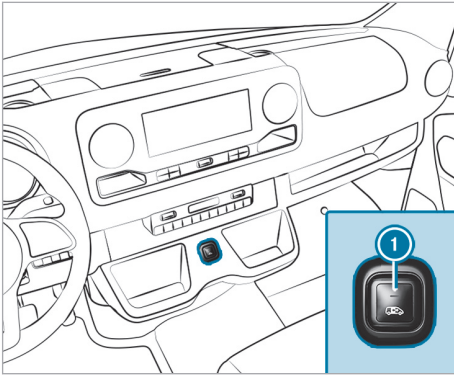

Sliding door button on the center console

Sliding door button on the center console

- ① Opens and closes the sliding door on the right side of the vehicle

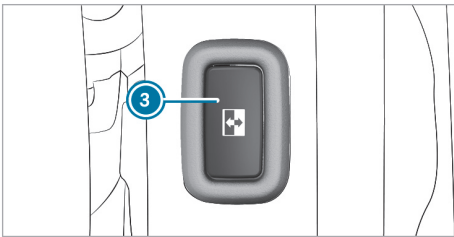

Sliding door button on the door frame (B-pillar)

You must reset the sliding door if there has been a malfunction or a voltage supply interruption.

- ▶ If the sliding door is open: press button ① on the center console or sliding door button ③ on the door frame (B-pillar) and hold it until the door is closed.

or

- ▶ Close the sliding door with the door handle (→ page 57).

- ▶ Then briefly press button ① on the center console or sliding door button ③ on the door frame (B-pillar) once, or pull the door handle (→ page 57) to open the sliding door completely.
The sliding door will be operational.

Rear-end doors

Opening and closing the rear-end doors from outside

- ⚠ **WARNING** Risk of injury due to the rear-end door swinging open

When you open a rear-end door, the following can occur:

- You or another person can be injured.
- A person may be struck by oncoming traffic.

This is particularly the case if you open the rear-end door more than 90° or if it opens in an uncontrolled manner.

Even rear-end doors which are properly closed can swing open when the vehicle parked is on an incline or it is windy.

- ▶ Only open a rear-end door when the traffic conditions and surroundings permit.
- ▶ Always make sure that the rear-end doors are properly closed.

- ⚠ **NOTE** Damage to the rear-end doors due to objects obstructing their range of movement

When the rear-end doors are opened, any objects obstructing the range of movement of the rear-end doors can be damaged as well as the vehicle.

- ▶ Make sure that there is sufficient clearance when opening the rear-end doors.

Opening the right rear-end door

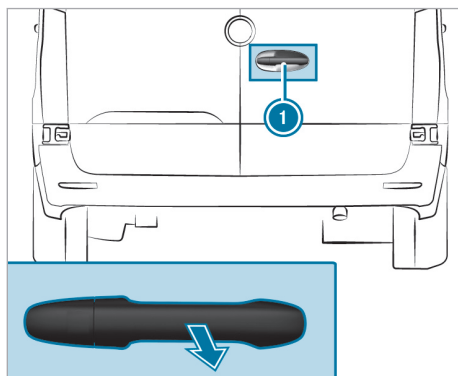

- ▶ Pull handle ①.
- ▶ Swing the rear-end door out to the side until it engages.

Opening the left rear-end door

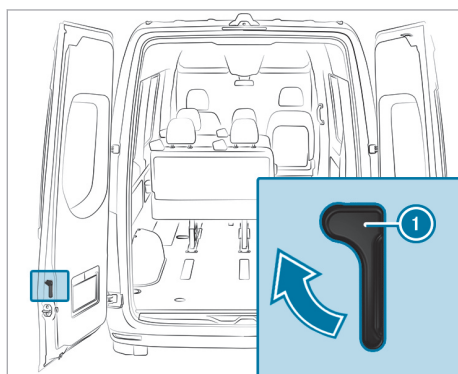

- ▶ Ensure that the right rear-end door is open and engaged.
- ▶ Pull release handle ① in the direction of the arrow.
- ▶ Swing the rear-end door out to the side until it engages.

Opening the rear-end doors fully

- ▶ Open the respective rear-end door beyond the first detent (90°).
- ▶ Open the rear-end door fully. The rear-end door will be retained in the stop position.

Closing the rear-end doors from outside

- ▶ Close the left rear-end door firmly from outside.
- ▶ Close the right rear-end door firmly from outside.

Opening rear-end doors with door retainer more than 90°

⚠ WARNING Risk of injury due to the rear-end door swinging open

When you open a rear-end door, the following can occur:

- You or another person can be injured.
- A person may be struck by oncoming traffic.

This is particularly the case if you open the rear-end door more than 90° or if it opens in an uncontrolled manner.

Even rear-end doors which are properly closed can swing open when the vehicle parked is on an incline or it is windy.

- ▶ Only open a rear-end door when the traffic conditions and surroundings permit.
- ▶ Always make sure that the rear-end doors are properly closed.

! NOTE Damage to the rear-end doors due to objects obstructing their range of movement

When the rear-end doors are opened, any objects obstructing the range of movement of the rear-end doors can be damaged as well as the vehicle.

- ▶ Make sure that there is sufficient clearance when opening the rear-end doors.

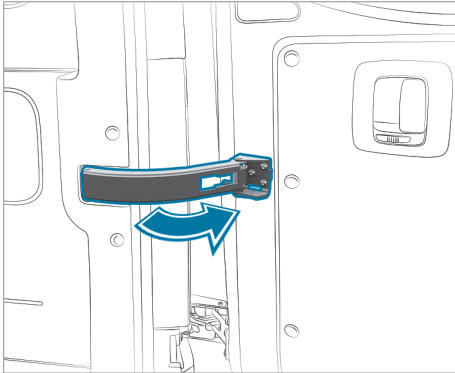

- ▶ Open the rear-end door approximately 45°.
- ▶ Pull and hold the door retainer in the direction of the arrow.
- ▶ Open the rear-end door at an angle greater than 90° so that the door retainer is no longer locked in place.
- ▶ Release the door check and open the tailgate to the steering limit.

Opening/closing the rear-end doors from the inside

⚠ WARNING Risk of injury due to the rear-end door swinging open

When you open a rear-end door, the following can occur:

- You or another person can be injured.
- A person may be struck by oncoming traffic.

This is particularly the case if you open the rear-end door more than 90° or if it opens in an uncontrolled manner.

Even rear-end doors which are properly closed can swing open when the vehicle parked is on an incline or it is windy.

- ▶ Only open a rear-end door when the traffic conditions and surroundings permit.
- ▶ Always make sure that the rear-end doors are properly closed.



❗ NOTE Damage to the rear-end doors due to objects obstructing their range of movement

When the rear-end doors are opened, any objects obstructing the range of movement of the rear-end doors can be damaged as well as the vehicle.

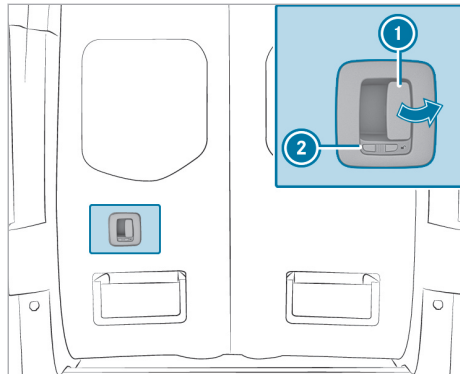
- ▶ Make sure that there is sufficient clearance when opening the rear-end doors.



The  symbol indicates that the rear-end door is unlocked.

- ▶ **To unlock:** slide latch **2** to the left. The  symbol is visible.
- ▶ **To open:** pull opening lever **1** and open the rear-end door. Swing the rear-end door to the side until it engages.
- ▶ **To close:** make sure that the left rear-end door is closed. Pull the rear right door firmly to by the door handle.
- ▶ **To lock:** slide latch **2** to the right. The  symbol is visible.

Partition sliding door

Opening and closing the partition sliding door

⚠ WARNING Risk of becoming trapped if the partition sliding door is not engaged

The partition sliding door may move on its own while the vehicle is in motion.

This can cause you or other people to become trapped.

- ▶ Before every journey, close the partition sliding door and ensure that it is engaged.

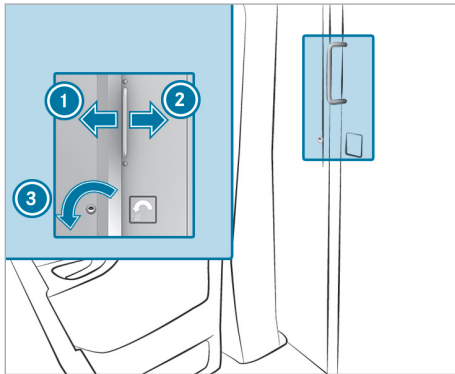

Partition from the cab

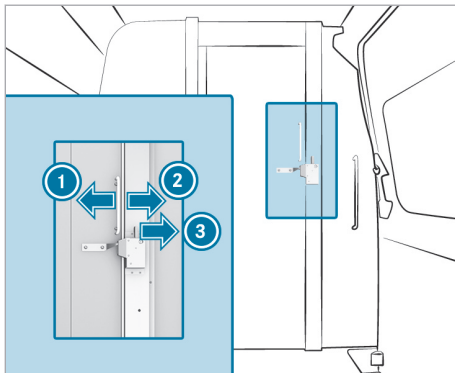

Partition from the cargo compartment

- ▶ **To open:** turn the key to the left ③ from the cab or push the lever to the right ③ from the cargo compartment. The sliding door will be unlocked.
- ▶ Push the sliding door as far as it will go to the right ② from the cab or to the left ① from the cargo compartment.
- ▶ **To close:** push the sliding door to the left ① from the cab or to the right ② from the cargo compartment until it engages. You can lock the sliding door from the cab with the key.

Electrical step

Function of the electrical step

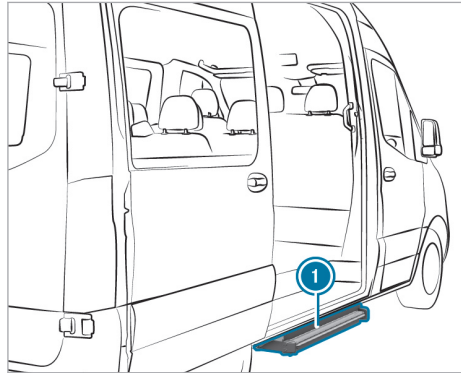

Your vehicle's sliding door may be equipped with an electrical step.

Electrical step ① automatically extends when the sliding door opens, and retracts after the sliding door closes. Electrical step ① is equipped with object recognition at the front. If the step meets an object while extending, it stops. Once you have removed the object, you must first close the sliding door and then open it again so that the step extends completely.

If the electrical step prevents loading, you can block it via object recognition when the sliding door opens. The electrical step then remains retracted and a fork-lift truck or another lifting vehicle can move closer to the cargo compartment.

- ⓘ The **Step Not Extended See Operator's Manual** or **Sliding Step Not Extended Malfunction See [🔧]** message appears on the instrument cluster display.

When the vehicle is switched off, a warning tone will sound if object recognition is blocked. The tone lasts for two minutes.

When the vehicle is switched on, the warning tone will sound continuously.

Vehicles with an instrument cluster (color): if the instrument cluster display shows the **Step Not Retracted See Operator's Manual** or **Step Not Extended See Operator's Manual** message and a warning tone sounds, electrical step ① is malfunctioning (→ page 304).

If electrical step ① is malfunctioning, the step may not extend or retract or do so only partially. After a malfunction occurs, you must retract and

lock electrical step ❶ manually in order to continue your journey (→ page 63). Before passengers exit the vehicle, inform them that electrical step ❶ may be missing.

Releasing the electrical step in an emergency (manual retraction)

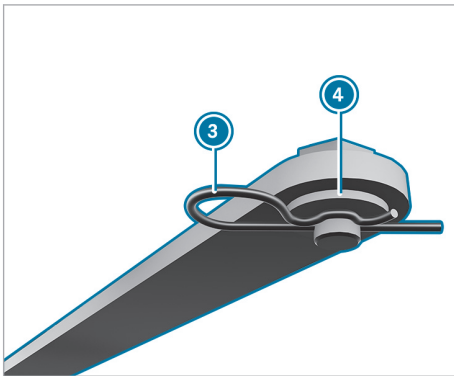
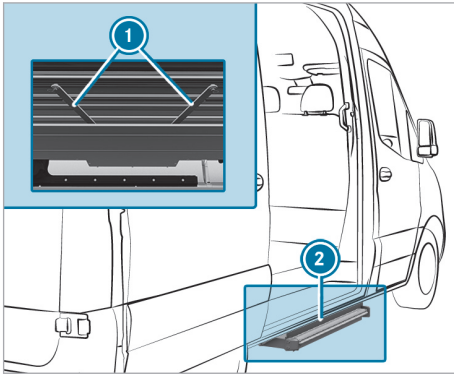

If the electrical step does not automatically retract, you must manually retract the step and lock it in order to continue driving.

- ▶ On the underside of step ❷ on both bars ❶ remove the spring cotters ❸ from the pin.
- ▶ Remove the washers ❹ and detach both bars.

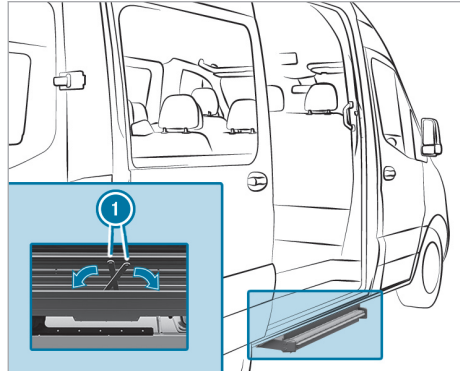

- ▶ Fold bars ❶ into the step's housing.
 - ▶ Slide the step into its housing.
- ❶ When securing the step for the first time, you must puncture a foil with the spring cotters.

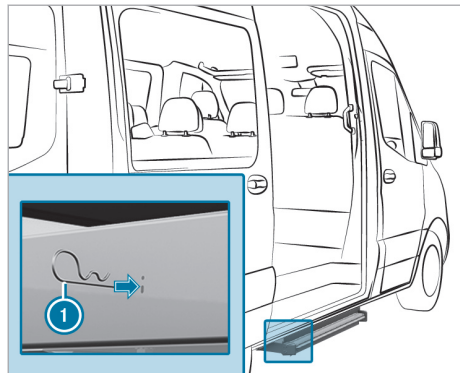

- ▶ On both sides, insert spring cotters ❶ through the housing's holes and into the step as far as they will go.
- The step has been secured in its housing.

Side window

Opening and closing the side windows

⚠ WARNING Risk of entrapment when opening a side window

When opening a side window, parts of the body could be drawn in or become trapped between the side window and window frame.

- ▶ When opening, make sure that nobody is touching the side window.

- ▶ If someone is trapped, release the button immediately or pull it in order to close the side window again.

⚠ WARNING Risk of becoming trapped when closing a side window

When closing a side window, body parts could be trapped in the closing area in the process.

- ▶ When closing, make sure that no body parts are in the closing area.
- ▶ If someone is trapped, release the button immediately or press the button in order to reopen the side window.

⚠ WARNING Risk of becoming trapped when children operate the side windows

Children could become trapped if they operate the side windows, particularly when unattended.

- ▶ Activate the child safety lock for the rear passenger compartment side windows.
- ▶ When leaving the vehicle, always take the SmartKey with you and lock the vehicle.
- ▶ Never leave children unattended in the vehicle.

⚠ WARNING Risk of fatal injury due to exposure to extreme heat or cold in the vehicle

If persons, particularly children, are subjected to prolonged exposure to intense heat or cold, there is a risk of severe injury or even death.

- ▶ Never leave persons, particularly children, unattended in the vehicle.

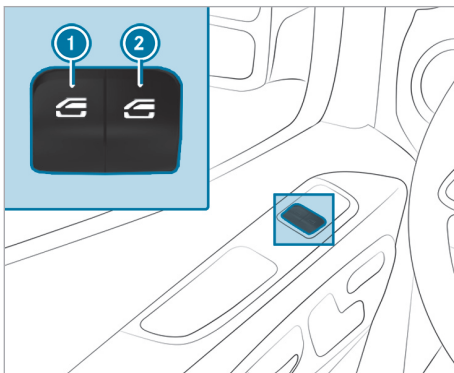

- ▶ **To open manually:** press and hold button ① or ②.
- ▶ **To close manually:** pull and hold button ① or ②.

The windows in the front doors can also be operated automatically.

- ▶ **To open completely:** briefly press button ① or ② beyond the pressure point. Automatic operation will start.
- ▶ **To close completely:** briefly pull button ① or ② beyond the pressure point. Automatic operation will start.
- ▶ **To interrupt automatic operation:** briefly press or pull button ① or ② again.

- ① If an object blocks a side window during the automatic closing process, the side window will open again automatically. The automatic reversing function is only an aid and is not a substitute for your attentiveness.
- ① If automatic operation of the side window does not work, there will also be no automatic reversing function.

Automatic reversing function of the side windows

If an object blocks a side window during the closing process, the side window will open again automatically. The automatic reversing function is only an aid and is not a substitute for your attentiveness.

- ▶ During the closing process, make sure that no body parts are in the closing area.

⚠ WARNING Risk of becoming trapped despite there being reversing protection on the side window

The reversing function will not react:

- to soft, light and thin objects, e.g. fingers
- over the last 1/4 in (4 mm) of the closing path
- during resetting
- when the side window is closed again manually immediately after automatic reversing

The reversing function cannot prevent someone from becoming trapped in these situations.

- ▶ During the closing process, make sure that no body parts are in the closing area.

- ▶ If someone becomes trapped, press the  button to open the side window again.

Adjusting the side windows

The side windows must be readjusted after a malfunction or a voltage supply interruption.

- ▶ Switch on the power supply (→ page 110).
- ▶ Push both buttons on the power window and hold for approximately one second after the side window has closed.

Rectifying problems with the side windows

A side window cannot be closed and you cannot see the cause

- ▶ Check to see if there are any objects in the window guide.

⚠ WARNING Risk of becoming trapped or fatally injured if reversing protection is not activated

If you close a side window again immediately after it has been blocked, the side window will close with increased or maximum force. The reversing function is then not active and body parts may become trapped.

- ▶ Make sure that no parts of the body are in the closing area.
- ▶ To stop the closing process, release the button or press the button again to reopen the side window.

If a side window is obstructed during closing and reopens again slightly, you can proceed as follows:

- ▶ Immediately after the window is obstructed, pull the corresponding button again until the side window has closed. Then pull and hold the button for another second. The side window will be closed with increased force.

If the side window is obstructed again and reopens slightly, you can proceed as follows:

- ▶ Repeat the previous step. The side window will be closed without the automatic reversing function.
- ▶ If a side window is obstructed again during closing and reopens again slightly, consult a qualified specialist workshop.

Anti-theft prevention

Function of immobilizer

The immobilizer prevents your vehicle from being started without the correct key.

The immobilizer is automatically activated when the vehicle is switched off, and deactivated when the vehicle is switched on.

When leaving the vehicle, always take the key with you and lock the vehicle. If the key is left inside the vehicle, anyone can start the vehicle.

- ⓘ In the event the engine does not start despite the vehicle's starter battery having sufficient charge, the immobilizer is faulty. Contact a qualified specialist workshop or call 1-800-367-6372 (in the USA) or 1-800-387-0100 (in Canada).

ATA (Anti-Theft Alarm system)

Function of ATA (Anti-Theft Alarm system)

If the ATA system is armed, a visual and audible alarm is triggered in the following situations:

- a side door is opened
- the rear-end door is opened
- the hood is opened
- the interior protection is triggered (→ page 67)
- the tow-away alarm is triggered (→ page 66)

The alarm will not be deactivated, even if the door which was opened to trigger the alarm is immediately closed again, for example.

Canceling a triggered alarm (→ page 66).

The ATA is activated automatically after approximately ten seconds in the following instance:

- after the vehicle has been locked with the key

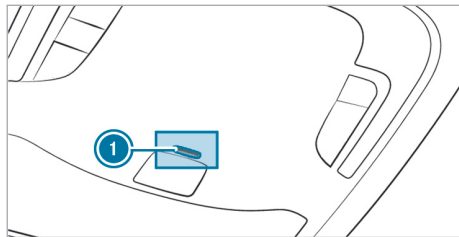

When the ATA system is armed, an indicator lamp  flashes in the overhead control panel.

ATA is automatically deactivated in the following situations:

- after unlocking the vehicle with the key
- after pressing the start/stop button with the key inside the vehicle.

Arms/deactivates ATA (anti-theft alarm system)

Arming

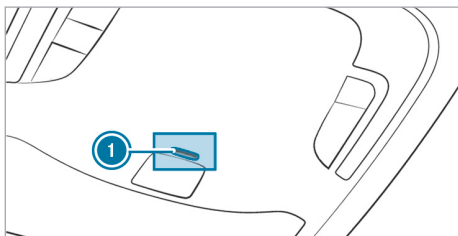



- ▶ Close all the doors.
- ▶ Close the side window or deactivate the interior protection (→ page 67) to prevent a false alarm.
- ▶ Lock the vehicle with the key. Indicator lamp ① in the overhead control panel flashes.

Deactivating

- ▶ Unlock the vehicle with the key. Indicator lamp ① in the overhead control panel goes out.
- ▶ The vehicle locks again automatically if you do not open a door within 40 seconds after unlocking the vehicle.

Stopping the alarm

- ▶ Press the  or  button on the key. or
- ▶ Press the Start/Stop button with the key inside the vehicle. The alarm stops.

Function of the tow-away alarm

When the tow-away alarm is armed, a visual and audible alarm is triggered if the vehicle's inclination changes. This may be the case, for example, if the vehicle is lifted on one side.

Arming or deactivating the tow-away alarm

Arming/deactivating

- ▶ Lock the vehicle with the key. The tow-away alarm is automatically armed after about 40 seconds:
- ▶ Open the vehicle with the key. The tow-away alarm is deactivated.

The tow-away alarm is activated if the following condition is met:

- All the doors are closed.

Deactivating

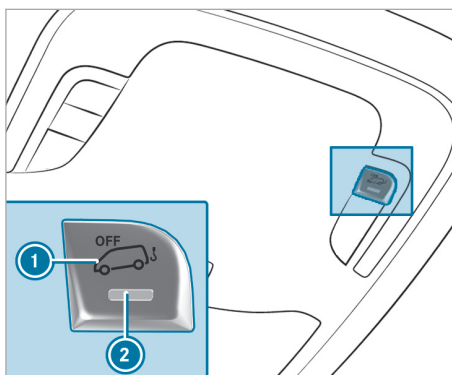

- ▶ Switch off the vehicle (→ page 110).
- ▶ Press the ① button. When the button is released, the indicator lamp ② in the button lights up for approximately three seconds.
- ▶ Lock the vehicle with the key. The tow-away alarm is deactivated.

The tow-away alarm is activated again in the following instances:

- the vehicle is unlocked again.
- a door is opened
- the vehicle is locked again.

Deactivate the tow-away alarm when locking your vehicle in the following situations:

- when loading and/or transporting the vehicle on a ferry or car transporter, for example
- when parking the vehicle on a movable surface, such as a split-level garage

False alarms will thus be prevented.

Interior protection

Function

A visual and acoustic alarm is triggered if the armed interior protection detects motion in the vehicle interior.

Depending on the respective vehicle equipment, the interior protection may be automatically deactivated temporarily if the stationary heater is switched on.

Arming/deactivating the interior protection

Arming

- ▶ Close the side windows.
- ▶ Ensure that no objects (such as mascots or clothes hangers) are hanging on the inside mirror or on the grab handles. False alarms will thus be prevented.
- ▶ Lock the vehicle with the key.
The interior protection is armed after approximately 40 seconds.

The interior protection is activated if the following condition is met:

- All the doors are closed.

Switching off

- ▶ Unlock the vehicle with the key.
The interior protection automatically switches off.

Deactivating

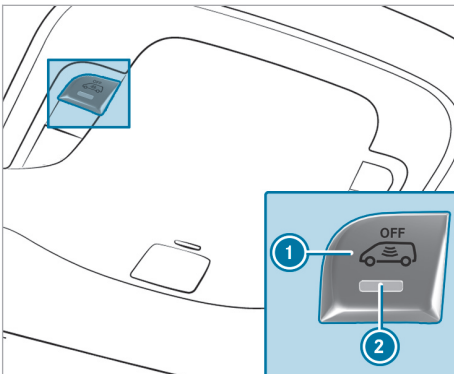

- ▶ Switch off the vehicle (→ page 110).
- ▶ Press the ① button.
When the button is released, indicator lamp ② in the button lights up for approximately three seconds.

- ▶ Lock the vehicle with the key.
The interior protection is deactivated.

The interior protection is activated again in the following instances:

- the vehicle is unlocked again.
- a door is opened
- the vehicle is locked again.

Deactivate the interior protection when locking your vehicle in the following situations:

- people or animals remain inside the vehicle
- if the side windows remain open
- when transporting the vehicle, for example on a ferry or car transporter.

False alarms will thus be prevented.

Notes on the correct driver's seat position

⚠ WARNING Risk of accident due to adjusting the vehicle settings while the vehicle is in motion

You could lose control of the vehicle in the following situations in particular:

- If you adjust the driver's seat, the head restraint, the steering wheel or the mirror while the vehicle is in motion
 - If you fasten your seat belt while the vehicle is in motion
- ▶ Before starting the vehicle: in particular, adjust the driver's seat, head restraint, steering wheel and mirror, and fasten your seat belt.

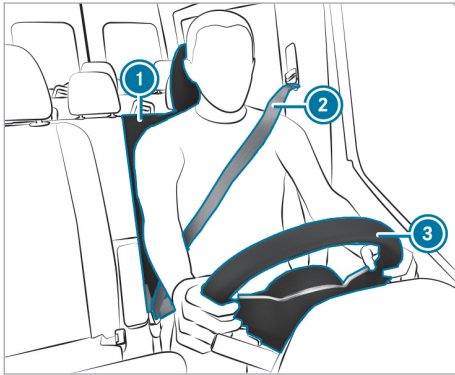

Ensure the following when adjusting steering wheel

③, seat belt ② or driver's seat ①:

- You are sitting as far away from the driver's air bag as possible.
- You are sitting in an upright position.
- Your thighs are gently supported by the seat cushion.
- Your legs are not fully extended and you can reach the pedals easily.
- The back of your head is supported at eye level by the middle part of the head restraint.
- You can hold the steering wheel with your arms slightly bent.
- You can move your legs without any restrictions.
- You can see all of the instrument cluster displays well.

- You have a good overview of the traffic conditions.
- Your seat belt sits snugly against your body and passes across the center of your shoulder and across your hips in the pelvic area.

Notes on grab handles

⚠ WARNING Risk of injury due to excessive load on the grab handles

If you apply your full body weight to the grab handle or pull it abruptly, the grab handle may be damaged or come loose from its anchorage. This may result in injuries.

- ▶ Use the grab handles only to stabilize the seating position or to assist in getting in and out of the seat.

Seats

Adjusting the front seats manually (without Seat Comfort Package)

⚠ WARNING Risk of becoming trapped if the seat is adjusted by children

Children could become trapped if they adjust the seats, particularly if they are unattended.

- ▶ When leaving the vehicle, always take the key with you and lock the vehicle.
- ▶ Never leave children unattended in the vehicle.

⚠ WARNING Risk of becoming trapped when adjusting the seat

When you adjust a seat, you or other vehicle occupants could become trapped, e.g. on the seat guide rail.

- ▶ When adjusting a seat, make sure that no one has any part of their body within the sweep of the seat.

Observe the safety notes on "Air bags" and "Children in the vehicle".

⚠ WARNING Risk of accident due to the driver's seat not being engaged

The driver's seat may move unexpectedly while driving.

This could cause you to lose control of the vehicle.

- ▶ Always make sure that the driver's seat is engaged before starting the vehicle.

⚠ WARNING Risk of accident due to adjusting the vehicle settings while the vehicle is in motion

You could lose control of the vehicle in the following situations in particular:

- If you adjust the driver's seat, the head restraint, the steering wheel or the mirror while the vehicle is in motion
 - If you fasten your seat belt while the vehicle is in motion
- ▶ Before starting the vehicle: in particular, adjust the driver's seat, head restraint, steering wheel and mirror, and fasten your seat belt.

⚠ WARNING Risk of becoming trapped if the seat height is adjusted carelessly

If you adjust the seat height carelessly, you or other vehicle occupants could be trapped and thereby injured.

Children in particular could accidentally press the electrical seat adjustment buttons and become trapped.

- ▶ While moving the seats, make sure that hands or other body parts do not get under the lever assembly of the seat adjustment system.

⚠ WARNING Risk of injury due to head restraints not being installed or being adjusted incorrectly

If head restraints have not been installed or have not been adjusted correctly, there is an increased risk of injury in the head and neck area, e.g. in the event of an accident or when braking.

- ▶ Always drive with the head restraints installed.
- ▶ Before driving off, make sure for every vehicle occupant that the center of the head restraint supports the back of the head at about eye level.

Do not interchange the head restraints of the front and rear seats. Otherwise, you will not be able to set the height and inclination of the head restraints to the correct position.

Using the head restraint fore-and-aft adjustment, adjust the head restraint so that it is as close to the back of your head as possible.

⚠ WARNING Risk of injury or death due to an incorrect seat position

The seat belt does not offer the intended level of protection if you have not moved the seat backrest to an almost vertical position.

In particular, you could slip beneath the seat belt and become injured.

- ▶ Adjust the seat properly before beginning your journey.
- ▶ Always ensure that the seat backrest is in an almost vertical position and that the shoulder belt is routed across the center of your shoulder.

! NOTE Damage to the seats when moving the seats back

The seats may be damaged by objects when moving the seats back.

- ▶ When moving the seats back, make sure that there are no objects in the footwell, under or behind the seats.

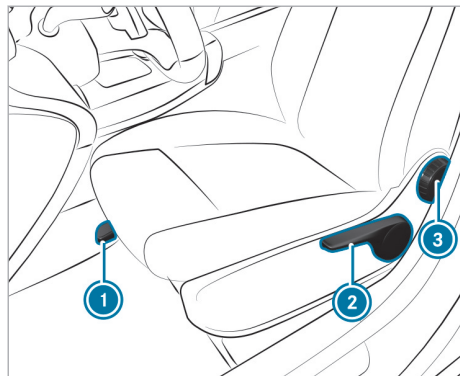

- ① Seat fore-and-aft position
- ② Seat height
- ③ Seat backrest inclination

- ▶ **To adjust the seat fore-and-aft position:** lift lever ❶ and slide the seat into the desired position. Ensure that the seat is engaged.
- ▶ **To adjust the seat height:** keep on pressing or pulling lever ❷ until the required seat height has been reached.
- ▶ **To adjust the seat backrest inclination:** rotate handwheel ❸ forwards and backwards until the desired position has been reached.

Adjusting the front seats manually (with Seat Comfort Package)

- ⚠ WARNING** Risk of becoming trapped if the seat is adjusted by children

Children could become trapped if they adjust the seats, particularly if they are unattended.

- ▶ When leaving the vehicle, always take the key with you and lock the vehicle.
- ▶ Never leave children unattended in the vehicle.

- ⚠ WARNING** Risk of becoming trapped when adjusting the seat

When you adjust a seat, you or other vehicle occupants could become trapped, e.g. on the seat guide rail.

- ▶ When adjusting a seat, make sure that no one has any part of their body within the sweep of the seat.

Observe the safety notes on "Air bags" and "Children in the vehicle".

- ⚠ WARNING** Risk of accident due to the driver's seat not being engaged

The driver's seat may move unexpectedly while driving.

This could cause you to lose control of the vehicle.

- ▶ Always make sure that the driver's seat is engaged before starting the vehicle.

- ⚠ WARNING** Risk of accident due to adjusting the vehicle settings while the vehicle is in motion

You could lose control of the vehicle in the following situations in particular:

- If you adjust the driver's seat, the head restraint, the steering wheel or the mirror while the vehicle is in motion
- If you fasten your seat belt while the vehicle is in motion

- ▶ Before starting the vehicle: in particular, adjust the driver's seat, head restraint, steering wheel and mirror, and fasten your seat belt.

- ⚠ WARNING** Risk of becoming trapped if the seat height is adjusted carelessly

If you adjust the seat height carelessly, you or other vehicle occupants could be trapped and thereby injured.

Children in particular could accidentally press the electrical seat adjustment buttons and become trapped.

- ▶ While moving the seats, make sure that hands or other body parts do not get under the lever assembly of the seat adjustment system.

- ⚠ WARNING** Risk of injury due to head restraints not being installed or being adjusted incorrectly

If head restraints have not been installed or have not been adjusted correctly, there is an increased risk of injury in the head and neck area, e.g. in the event of an accident or when braking.

- ▶ Always drive with the head restraints installed.
- ▶ Before driving off, make sure for every vehicle occupant that the center of the head restraint supports the back of the head at about eye level.

Do not interchange the head restraints of the front and rear seats. Otherwise, you will not be able to set the height and inclination of the head restraints to the correct position.

Using the head restraint fore-and-aft adjustment, adjust the head restraint so that it is as close to the back of your head as possible.

⚠ WARNING Risk of injury or death due to an incorrect seat position

The seat belt does not offer the intended level of protection if you have not moved the seat backrest to an almost vertical position.

In particular, you could slip beneath the seat-belt and become injured.

- ▶ Adjust the seat properly before beginning your journey.
- ▶ Always ensure that the seat backrest is in an almost vertical position and that the shoulder belt is routed across the center of your shoulder.

1 NOTE Damage to the seats when moving the seats back

The seats may be damaged by objects when moving the seats back.

- ▶ When moving the seats back, make sure that there are no objects in the footwell, under or behind the seats.

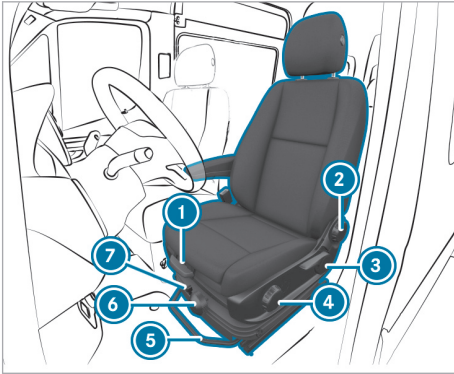

Example image of comfort suspension seat

- ① Seat cushion length
- ② Seat backrest inclination
- ③ Seat height
- ④ Seat cushion inclination
- ⑤ Seat fore-and-aft position
- ⑥ Seat suspension
- ⑦ Seat suspension lock

- ▶ **To adjust the seat cushion length:** lift lever ① and slide the front part of the seat cushion forwards or backwards.

- ▶ **To adjust the seat backrest inclination:** rotate handwheel ② forwards and backwards until the desired position has been reached.
- ▶ **To adjust the seat height:** pull or push lever ③ until the desired position has been reached.
- ▶ **To adjust the seat cushion inclination:** rotate handwheel ④ forwards and backwards until the desired position has been reached.
- ▶ **To adjust the seat fore-and-aft position:** lift lever ⑤ and slide the seat into the desired position.
- ▶ **To check for safety:** ensure that the seat is engaged.
- ▶ **To adjust the seat suspension:** take your weight off the seat.
- ▶ Using handwheel ⑥, set the body weight (88 lb (40 kg) to 265 lb (120 kg)) so that the seat suspension works optimally. If you set a higher weight, the seat suspension will become firmer. The seat will then not vibrate as much. If the seat vibrates often and significantly, you can engage it in the lower area.
- ▶ **To engage the seat suspension lock:** turn lever ⑦ upwards. The next time the seat vibrates, it will engage.
- ▶ **To release the seat suspension lock:** turn lever ⑦ to the right. The seat will then be able to vibrate.

Adjusting the front seat electrically

⚠ WARNING Risk of becoming trapped if the seat is adjusted by children

Children could become trapped if they adjust the seats, particularly if they are unattended.

- ▶ When leaving the vehicle, always take the key with you and lock the vehicle.
- ▶ Never leave children unattended in the vehicle.

The seats can be adjusted when the vehicle is switched off.

⚠ WARNING Risk of becoming trapped when adjusting the seat

When you adjust a seat, you or other vehicle occupants could become trapped, e.g. on the seat guide rail.

- ▶ When adjusting a seat, make sure that no one has any part of their body within the sweep of the seat.

Observe the safety notes on "Air bags" and "Children in the vehicle".

▲ WARNING Risk of accident due to the driver's seat not being engaged

The driver's seat may move unexpectedly while driving.

This could cause you to lose control of the vehicle.

- ▶ Always make sure that the driver's seat is engaged before starting the vehicle.

▲ WARNING Risk of accident due to adjusting the vehicle settings while the vehicle is in motion

You could lose control of the vehicle in the following situations in particular:

- If you adjust the driver's seat, the head restraint, the steering wheel or the mirror while the vehicle is in motion
 - If you fasten your seat belt while the vehicle is in motion
- ▶ Before starting the vehicle: in particular, adjust the driver's seat, head restraint, steering wheel and mirror, and fasten your seat belt.

▲ WARNING Risk of becoming trapped if the seat height is adjusted carelessly

If you adjust the seat height carelessly, you or other vehicle occupants could be trapped and thereby injured.

Children in particular could accidentally press the electrical seat adjustment buttons and become trapped.

- ▶ While moving the seats, make sure that hands or other body parts do not get under the lever assembly of the seat adjustment system.

▲ WARNING Risk of injury due to head restraints not being installed or being adjusted incorrectly

If head restraints have not been installed or have not been adjusted correctly, there is an

increased risk of injury in the head and neck area, e.g. in the event of an accident or when braking.

- ▶ Always drive with the head restraints installed.
- ▶ Before driving off, make sure for every vehicle occupant that the center of the head restraint supports the back of the head at about eye level.

Do not interchange the head restraints of the front and rear seats. Otherwise, you will not be able to set the height and inclination of the head restraints to the correct position.

Using the head restraint fore-and-aft adjustment, adjust the head restraint so that it is as close to the back of your head as possible.

▲ WARNING Risk of injury or death due to an incorrect seat position

The seat belt does not offer the intended level of protection if you have not moved the seat backrest to an almost vertical position.

In particular, you could slip beneath the seat-belt and become injured.

- ▶ Adjust the seat properly before beginning your journey.
- ▶ Always ensure that the seat backrest is in an almost vertical position and that the shoulder belt is routed across the center of your shoulder.

! NOTE Damage to the seats when moving the seats back

The seats may be damaged by objects when moving the seats back.

- ▶ When moving the seats back, make sure that there are no objects in the footwell, under or behind the seats.

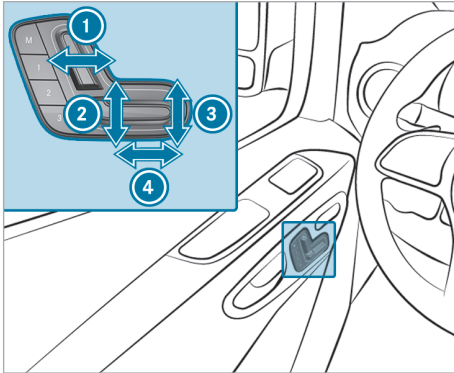

- ① Seat backrest inclination
 - ② Seat height
 - ③ Seat cushion inclination
 - ④ Seat fore-and-aft position
- ▶ Save the settings with the memory function (→ page 73).

Setting 4-way lumbar support

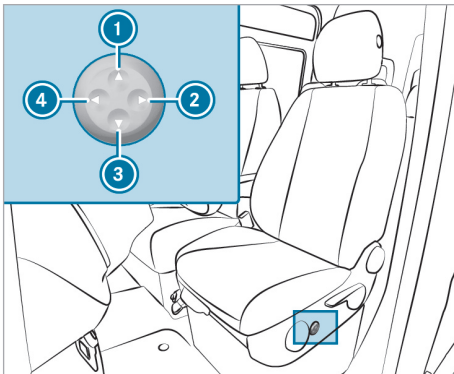

- ① Higher
 - ② Softer
 - ③ Lower
 - ④ Firmer
- ▶ Use buttons ① to ④ adjust the backrest contour individually to your spine.

Operating the memory function

⚠ WARNING Risk of an accident if the memory function is used while driving

If you use the memory function on the driver's side while driving, you could lose control of the vehicle as a result of the adjustments being made.

- ▶ Only use the memory function on the driver's side when the vehicle is stationary.

⚠ WARNING Risk of entrapment when adjusting the seat with the memory function

When the memory function adjusts the seat, you and other vehicle occupants – particularly children – could become trapped.

- ▶ During the adjustment process of the memory function, make sure that no one has any body parts in the sweep of the seat.
- ▶ If somebody becomes trapped, immediately release the memory function position button. The adjustment process is stopped.

⚠ WARNING Danger of entrapment when memory function is activated by children

When children activate the memory function, they can get trapped, especially if they are unsupervised.

- ▶ Never leave children unattended in the vehicle.
- ▶ When leaving the vehicle, always take the key with you and lock the vehicle.

The memory function can be used when the vehicle is switched off.

Storing seat adjustments

Seat adjustments for up to three people can be stored and called up using the memory function. You can adjust the seat and the backrest.

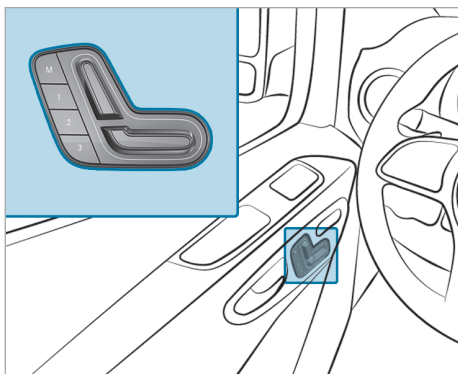

- ▶ Adjust the seat to the desired position.
- ▶ Press memory button M together with one of preset position buttons 1, 2 or 3. An acoustic signal will sound. The settings are stored.
- ▶ **To call up:** press and hold preset position button 1, 2 or 3 until the front seat is in the stored position.

Rotating the front seats

- ▲ **WARNING** Risk of injury or fatal injuries if the driver's seat and front passenger seat are not engaged

In this situation, the restraint systems cannot perform their intended protective function.

- ▶ Engage the driver's seat and front passenger seat in the direction of travel before you start the vehicle.

- ▲ **WARNING** Risk of accident due to adjusting the vehicle settings while the vehicle is in motion

You could lose control of the vehicle in the following situations in particular:

- If you adjust the driver's seat, the head restraint, the steering wheel or the mirror while the vehicle is in motion
- If you fasten your seat belt while the vehicle is in motion
- ▶ Before starting the vehicle: in particular, adjust the driver's seat, head restraint, steering wheel and mirror, and fasten your seat belt.

- ▲ **WARNING** Risk of injury when the seat is pushed backwards

If the seat has been pushed backwards, you may injure yourself on the seat guide rails protruding at the front.

- ▶ Make sure that you do not touch the seat guide rails.



You can rotate the driver's and front passenger seats by 50° and 180°. The seats engage both in and opposite to the direction of travel as well as at 50° towards the exit.

- ▶ Ensure that the parking brake is applied and the brake lever (if applicable) is down as far as it will go (→ page 142, 140).
- ▶ When rotating the seat, open the respective front door in order to avoid a collision with the door trim.
- ▶ Adjust the steering wheel in such a way that there is sufficient clearance to rotate and adjust the driver's seat (→ page 80).
- ▶ Slide the front passenger seat forward before rotating it (→ page 68).
- ▶ **To rotate the seat:** push lever ① towards the door and rotate the seat slightly inwards. The turning device will be unlocked.
- ▶ Release lever ① again.
- ▶ Rotate the seat outwards or inwards into the required position.

Folding the co-driver bench seat cushion forwards and backwards

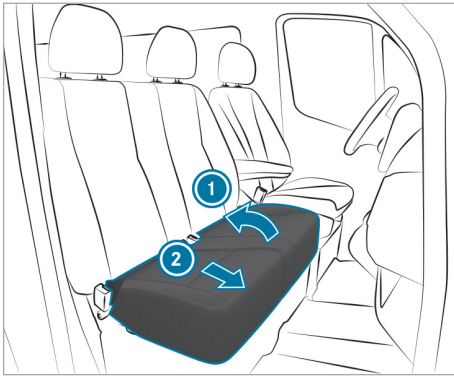

- ▶ **To fold the seat surface forward:** lift seat surface out of front anchorage ①.
- ▶ Pull the seat surface out of rear anchorage ② and move it slightly forwards.
- ▶ Fold the rear edge of the seat surface upwards.

ⓘ You can stow individual objects in the stowage compartment beneath the co-driver bench seat.

- ▶ **To fold back the seat surface:** fold the rear edge of the seat surface downwards.
- ▶ Slide the seat surface under the seat backrest into rear anchorage ②.
- ▶ Push the front seat surface downwards until it engages in front anchorage ①.

Folding the folding seat up or down

⚠ WARNING Risk of injury when using the folding seat due to inserted key

The key in the lock of the partition wall sliding door may come into contact with the person on the folding seat.

- ▶ Always remove the key before a person sits on the folding seat.

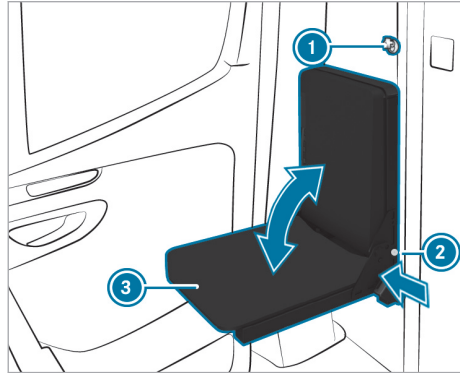

- ▶ Remove key ① from the partition sliding door.
- ▶ Press the push button on catch ② and fold seat cushion ③ up or down.
- ▶ Release push button on catch ② when seat cushion ③ reaches its end position.
- ▶ Move seat cushion ③ until it has locked. The push button on catch ② must be completely flush with the seat frame.

Installing and removing the rear bench seat

⚠ WARNING Risk of injury due to incorrect installation of the rear bench seat

If the rear seat is unsuitable, the seat belts may not perform their intended protective function.

- ▶ Install the rear seat bench as described and only in the direction of travel.
- ▶ Installation of the rear bench seat in a face-to-face position is not permitted.
- ▶ Use only rear bench seats that have been approved by Mercedes-Benz for your vehicle.

⚠ WARNING Risk of injury if the rear bench seat is not locked in place

If the rear bench seat is not stable, it may tip over during a journey.

- ▶ Before setting off, ensure that the rear bench seat is engaged. The red indicator tabs must not be visible on the release handle.

▶ If the red indicator tabs are visible on the release handle, re-engage the rear bench seat.

⚠ WARNING Risk of injury when installing and removing the rear bench seat

When you install or remove the rear bench seat, body parts such as feet may become trapped when the rear bench seat is tipped.

▶ When installing and removing the rear bench seat, ensure that there are no body parts between the rear bench seat and the floor.

! NOTE Damage to the rear bench seat rollers due to misuse

If the rear bench seat is used improperly or removed incorrectly, the rear bench seat rollers may be damaged.

- ▶ If the rear bench seat is in the seat shell, do not pull it towards the rear-end door. Roll the rear seat only beside the seat shells.
- ▶ Do not roll or use the rear bench seat as a means of transport when removed.

Installation position of three-person and four-person rear bench seat with strut

The three-person rear bench seat is available with or without a strut. The four-person rear bench seat is available only with a strut.

The strut is located on the rear side of the rear bench seat.

Install the three-person rear bench seat with strut only in the 3rd seat row (above the rear axle). Install the four-person rear bench seat only on the last seat row.

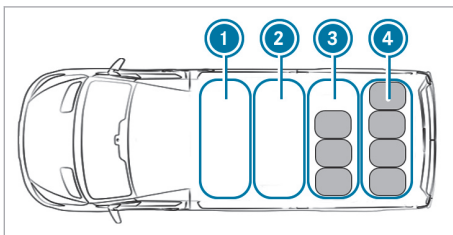

Vehicles with four seat rows

- ① 1st seat row
- ② 2nd seat row

- ③ 3rd seat row: three-person rear bench seat with strut
- ④ 4th seat row: four-person rear bench seat with strut

- ▶ Install the three-person rear bench seat on the 3rd seat row ③.
- ▶ Install the four-person rear bench seat on the 4th seat row ④.

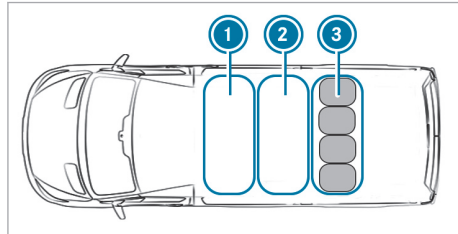

Vehicles with three seat rows

- ① 1st seat row
- ② 2nd seat row
- ③ 3rd seat row: four-person rear bench seat with strut

- ▶ Install the four-person rear bench seat on the 3rd seat row ③.

Removing the rear bench seat

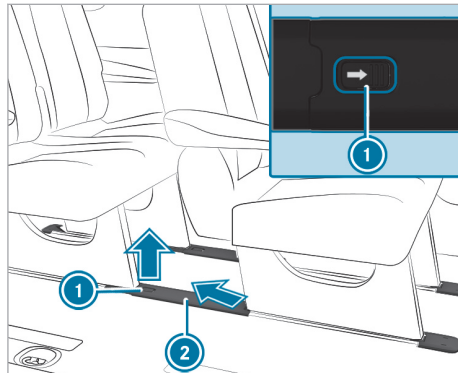

Perform these tasks carefully with the assistance of a 2nd person.

- ▶ **To remove the covers of the seat shells:** push retaining clip ① in the direction of the arrow and detach cover ② by pushing it to the top rear at an angle.

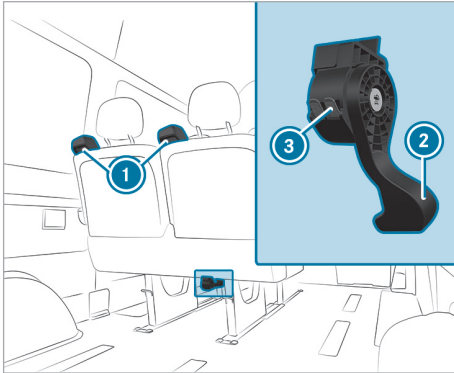

- ▶ Push release handle ② for the bench seat all the way down and hold it there. At the same time, tilt the bench seat backwards slightly using the release handle and pull it slightly backwards.
- ▶ Let go of the release handle. The locks on the bench seat legs will be unlocked and red indicator tabs ③ on the housing of release handle ② will be visible.
- ▶ Hold the unlocked bench seat by grab handles ① and pull backwards slightly.

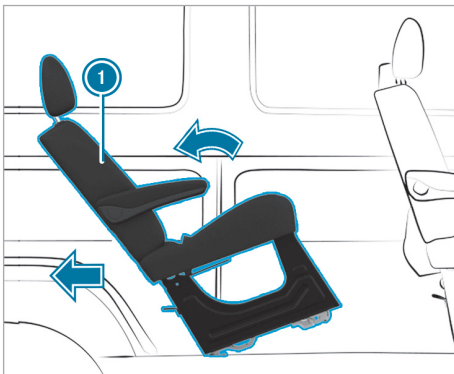

- ▶ Tilt bench seat ① backwards and pull it out of the seat shells.

ⓘ If the bench seat cannot be pulled out of the seat shells, the bench seat may be wedged in the seat anchorage. This can happen if the bench seat is tilted too far backwards.

If the seat cannot be pulled out of the seat shells, proceed as follows:

- ▶ Tilt the bench seat forwards without engaging it.

- ▶ Pull the bench seat backwards again using release handle ②.
- ▶ Tilt the bench seat slightly backwards and pull it out of the seat shells.
- ▶ To remove or store the bench seat, place it next to the seat shells and roll it towards the rear doors.

or

- ▶ Lift the bench seat out from the side to store it.

ⓘ It may be necessary for the bench seats in front or behind to be removed.

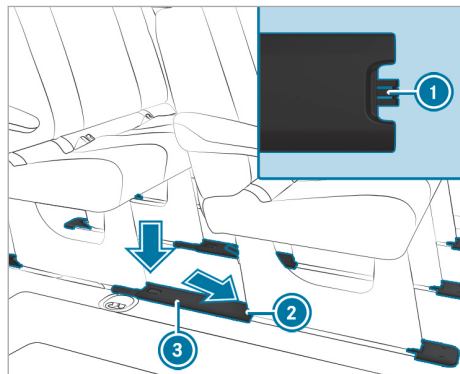

- ▶ **To attach the covers of the seat shells:** hold cover ③ such that retaining lug ① is pointing towards rear seat anchorage ②.
- ▶ Insert cover ③ into rear seat anchorage ② by pushing it downwards at an angle and then clip it to the seat shell.
- ▶ After removing the rear bench seats, ensure that the rear bench seats stand firmly and cannot tip over when in storage.

Please note that the metallic seat support in the vehicle floor will heat up during a journey if the rear seating has been removed.

Installing the rear bench seat



Warning notice on the rear bench seat

Secure engagement of the rear bench seat is guaranteed only if the seat anchorages are kept clean and free of objects.

- i In vehicles registered as passenger vehicles, observe the maximum permitted number of seats.
- ▶ Remove the covers of the seat shells as described under "Removing the rear bench seat".
- ▶ Ensure that there are no objects in the seat anchorages and seat shells.
- ▶ Position the bench seat behind the installation position.
- ▶ Hold the bench seat by the grab handles and tilt it backwards.
- ▶ Roll the bench seat forwards on the level plastic carriers.
- ▶ Ensure that the rear legs of the bench seat are engaged.

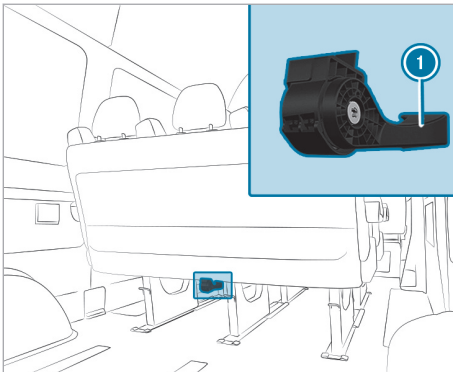

- ▶ Tilt the bench seat forwards firmly until the locks on the front legs of the bench seat engage audibly. The locks on the front legs of the bench seat will now be locked and the red indicator tabs on the housing of release handle 1 should no longer be visible.

i If the red indicator tabs on the release handle housing are visible, the bench seat is not correctly engaged.

If the bench seat is not correctly engaged, you can rectify this situation as follows:

- ▶ Unlock the bench seat again and tilt it forwards firmly until the locks on the bench seat front legs engage audibly.
- ▶ Attach the covers of the seat shells as described under "Removing the rear bench seat".

Adjusting the seat backrest of the rear bench seat

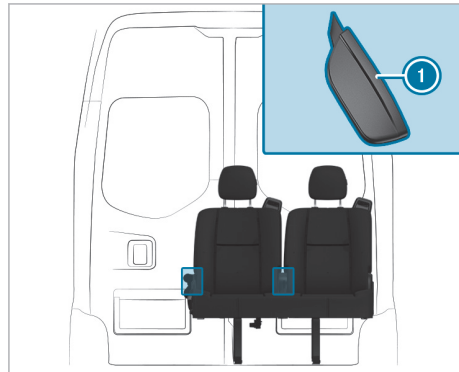

- i If a partition is installed: the rear bench seat must not come into contact with the partition at any time.
- ▶ Move the seat backrest to the desired position.

Head restraints

Adjusting the head restraint manually

⚠ WARNING Risk of accident due to adjusting the vehicle settings while the vehicle is in motion

You could lose control of the vehicle in the following situations in particular:

- If you adjust the driver's seat, the head restraint, the steering wheel or the mirror while the vehicle is in motion
- If you fasten your seat belt while the vehicle is in motion

▶ Before starting the vehicle: in particular, adjust the driver's seat, head restraint, steering wheel and mirror, and fasten your seat belt.

⚠ WARNING Risk of injury due to head restraints not being installed or being adjusted incorrectly

If head restraints have not been installed or have not been adjusted correctly, there is an increased risk of injury in the head and neck area, e.g. in the event of an accident or when braking.

- ▶ Always drive with the head restraints installed.
- ▶ Before driving off, make sure for every vehicle occupant that the center of the head restraint supports the back of the head at about eye level.

Do not interchange the head restraints of the front and rear seats. Otherwise, you will not be able to set the height and inclination of the head restraints to the correct position.

Using the head restraint fore-and-aft adjustment, adjust the head restraint so that it is as close to the back of your head as possible.

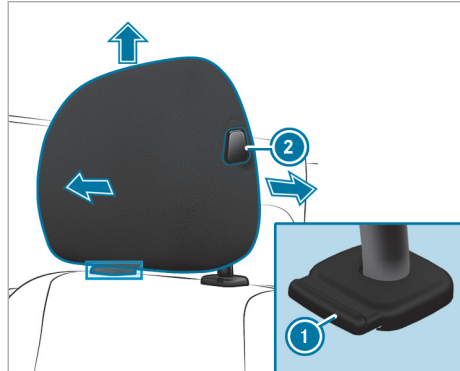

Head restraint (example of luxury head restraint on the driver's seat)

▶ **To raise:** pull the head restraint upwards into the desired position and ensure that it engages.

ⓘ Use the head restraint only when it is engaged.

▶ **To lower:** press release button ①, slide the head restraint downwards into the desired position and ensure that it engages.

ⓘ Use the head restraint only when it is engaged.

▶ **To move forwards:** press release button ② and pull the head restraint forwards until it engages in the desired position.

▶ **To move backwards:** press release button ② and slide the head restraint backwards into the desired position.

▶ **To remove:** press release button ① and pull the head restraint up and out.

▶ **To install:** press the head restraint with detent on the left-hand side when viewed in the direction of travel into the holes until it engages.

Switching the seat heating on/off

⚠ WARNING Risk of burns due to repeatedly switching on the seat heating

Repeatedly switching on the seat heating can cause the seat cushion and seat backrest padding to become very hot.

In particular, the health of persons with limited temperature sensitivity or a limited ability to react to high temperatures may be affected or they may even suffer burn-like injuries.

- ▶ Do not repeatedly switch on the seat heating.

To protect against overheating, the seat heating may be temporarily deactivated after it is switched on repeatedly.

- I NOTE** Damage to the seats caused by objects or documents when the seat heating is switched on

When the seat heating is switched on, overheating may occur due to objects or documents placed on the seats, e.g. seat cushions or child seats. This could cause damage to the seat surface.

- ▶ Make sure that no objects or documents are on the seats when the seat heating is switched on.

Requirements:

- The power supply is switched on.

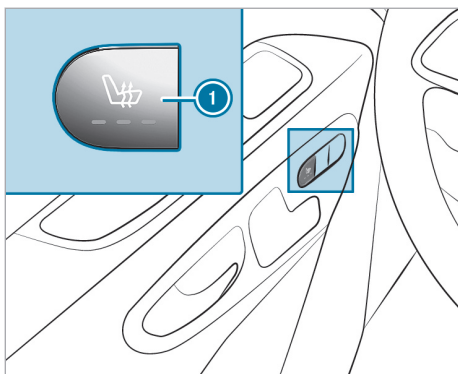

- ▶ **To switch on:** press the ① button. All indicator lamps on the button light up.
 - ▶ **To lower the level:** press button ① until the required heating level is reached. Depending on the heating level, one to three indicator lamps will light up.
 - ▶ **To switch off:** press button ① until all indicator lamps are off.
- ① The seat heater automatically switches back out of the three heating levels after 8, 10 and 20 minutes until the seat heater switches off.

Steering wheel

Adjusting the steering wheel

- ⚠ WARNING** Risk of accident due to adjusting the vehicle settings while the vehicle is in motion

You could lose control of the vehicle in the following situations in particular:

- If you adjust the driver's seat, the head restraint, the steering wheel or the mirror while the vehicle is in motion
- If you fasten your seat belt while the vehicle is in motion

- ▶ Before starting the vehicle: in particular, adjust the driver's seat, head restraint, steering wheel and mirror, and fasten your seat belt.

- ⚠ WARNING** Risk of accident due to unlocked steering wheel

The steering wheel may move unexpectedly if it is unlocked while the vehicle is in motion.

- ▶ Make sure that the steering wheel is locked before driving off.
- ▶ Never unlock the steering wheel when the vehicle is in motion.

- ⚠ WARNING** Risk of entrapment for children when adjusting the steering wheel

Children could injure themselves if they adjust the steering wheel.

- ▶ Never leave children unattended in the vehicle.
- ▶ When leaving the vehicle, always take the SmartKey with you and lock the vehicle.

Adjusting the steering wheel

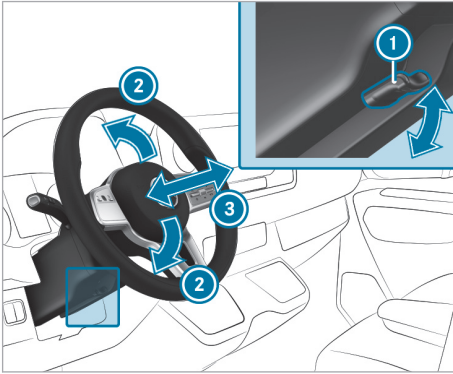

- ① Lever
- ② Steering column height
- ③ Steering column fore-and-aft adjustment

- ▶ **To unlock:** swing lever ① down as far as it will go.
The steering wheel is unlocked.
- ▶ **To lock:** pull lever ① up as far as it will go.
The steering wheel is locked.

Adjusting the steering wheel

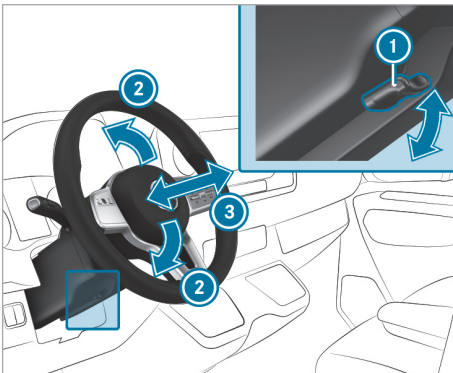

- ① Lever
- ② Steering column height
- ③ Steering column fore-and-aft adjustment

- ▶ **To unlock:** swing lever ① down as far as it will go.
The steering wheel is unlocked.
- ▶ **To lock:** pull lever ① up as far as it will go.
The steering wheel is locked.

Stowage areas

Overview of the front stowage compartments

Overview of the front storage compartments

Observe the notes on loading the vehicle (→ page 209).

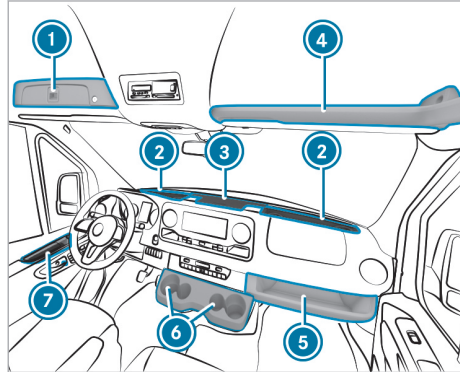

- ① Lockable compartment above windshield (subject to a maximum load of 4 lb (2 kg))
- ② Windshield storage compartment with two cup holders / ashtray stowage space
Storage compartment with cover, depending on specification
- ③ Center console storage compartment with USB port, charging interface, NFC interface and 12 V socket
- ④ Storage compartment above windshield (subject to a maximum load of 5 lb (2.5 kg))
- ⑤ Front passenger side storage compartment (subject to a maximum load of 11 lb (5 kg))
- ⑥ Cup holder (→ page 82)
- ⑦ Storage compartment in the doors

Information about the bottle holder

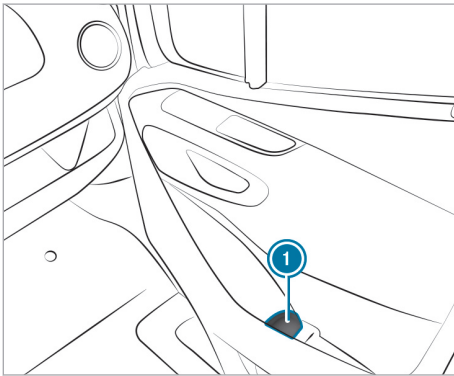

- ① Bottle holder in the front doors (example: front passenger door)

Cup holders

Overview of cup holders in the center console

⚠ WARNING - Risk of accident or injury when using the cup holder while the vehicle is moving

The cup holder cannot secure containers while the vehicle is moving.

If you use a cup holder while the vehicle is moving, the container may be flung around and liquids may be spilled. The vehicle occupants may come into contact with the liquid and if it is hot, they could be scalded. You could be distracted from traffic conditions and you may lose control of the vehicle.

- ▶ Only use the cup holder when the vehicle is stationary.
- ▶ Only use the cup holder for containers of the right size.
- ▶ Close the container, particularly if the liquid is hot.

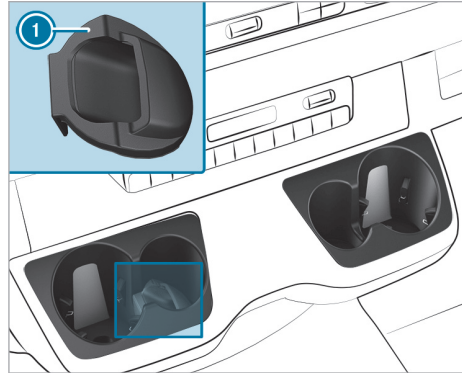

The cup holders for the driver and front passenger are in the center console.

Key holder ① for vehicles with a reduced antenna detection range (KEYLESS-START) is located in the driver's cup holder.

For vehicles with manual transmission, the key holder is in the cup holder on the front passenger side.

Opening the cup holder in the rear passenger compartment

⚠ WARNING Risk of injury due to cup holder being extended when exiting the vehicle

You may bump into the cup holder.

- ▶ Before getting out of the vehicle, push the cup holder back under the rear bench seat.

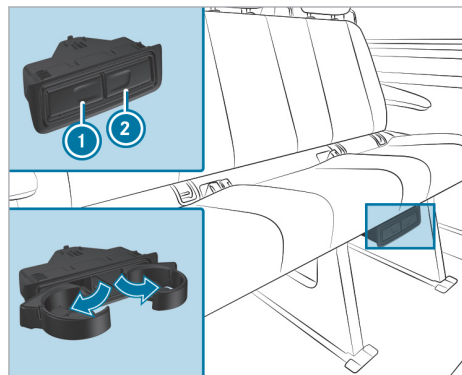

- ▶ **To open:** press on cup holder ① or ②.
- ▶ Fold out the cup holder.

- ▶ **To close:** slide cup holder ① or ② back in until it engages.

Ashtray and cigarette lighter

Using ashtrays

- ▶ Place the closed ashtray in a cup holder in the windshield stowage compartments.
- ▶ Check that the ashtray is seated securely.
- ① Do not place the ashtray in the center console cup holders. It cannot sit securely here.

Using the cigarette lighter in the center console

⚠ WARNING Risk of fire and injury from hot cigarette lighter

You can suffer burns if you touch the hot heating element or the hot socket of the cigarette lighter.

In addition, flammable materials can catch fire if:

- you drop the hot cigarette lighter.
- children e.g. hold the hot cigarette lighter to objects.

- ▶ Always hold the cigarette lighter by the knob.
- ▶ Always make sure that the cigarette lighter is out of the reach of children.
- ▶ Never leave children unattended in the vehicle.

Requirements:

- The vehicle is switched on.

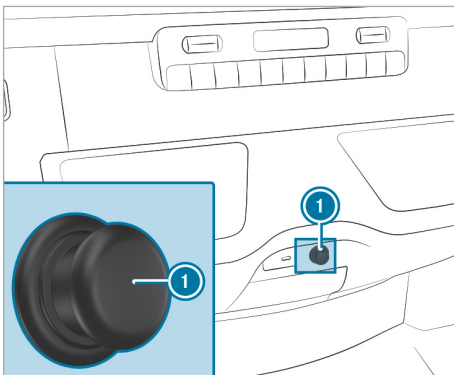

- ▶ Press in cigarette lighter ①. The cigarette lighter will pop out when the heating element is red-hot.

Sockets

Using 12 V sockets

Requirements:

- Only devices with a maximum power consumption of 180 W (15 A) may be connected.

12 V socket in the storage compartment

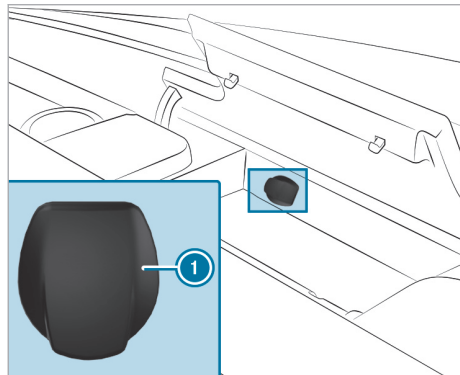

- ▶ Open the lid of the storage compartment in the center console.
- ▶ Fold up cover ① of the socket.
- ▶ Insert the plug of the device.
- ① Depending on the vehicle equipment, the vehicle has additional 12 V sockets:
 - in the lower control panel in the front center console
 - in the driver's seat
 - in the cargo compartment

Notes on the 115 V socket

ⓘ NOTE Damage to the auxiliary battery due to full discharge

The auxiliary battery may become damaged if a device with too high a power output is connected when you leave the vehicle, or the auxiliary battery's charge level is low.

- ▶ Only connect devices up to a maximum of 150 W.

- ▶ Do not leave devices connected for longer than four hours.

Vehicles with an auxiliary battery have a run-on function. If you leave the vehicle, you can charge devices over a period of up to four hours. If the vehicle is switched on and off again during the run-on period, the run-on function starts again for another four hours.

Using the 115 V socket in the center console

- ⚠ DANGER** Risk of fatal injuries due to a damaged connecting cable or a damaged socket

You could receive an electric shock if the connecting cable or the 115 V power socket is pulled out of the trim or is damaged or wet.

- ▶ Use only connecting cables that are dry and free of damage.
- ▶ When the vehicle is switched off, make sure that the 115 V power socket is dry.
- ▶ Immediately have the 115 V power socket checked or replaced at a qualified specialized workshop if it is damaged or has been pulled out of the trim.
- ▶ Never plug the connecting cable into a 115 V power socket that is damaged or has been pulled out of the trim.

- ⚠ DANGER** Risk of death due to using the socket incorrectly

In particular, you could receive an electric shock:

- If you touch the inside of the socket
- If you insert unsuitable devices or objects into the socket
- ▶ Do not touch the inside of the socket.
- ▶ Only connect suitable devices to the socket.

- ⚠ DANGER** Risk of fatal injuries due to electric shock

If you clean the 115 V socket with a wet cloth, you can get an electric shock.

There is a risk of fatal injury!

- ▶ Avoid the area around the 115 V socket when cleaning.

Requirements

- Only connect devices with a suitable plug which conforms to the standards specific to the country you are in.
- Only connect devices up to a maximum of 150 W.
- Do not use multiple socket outlets.

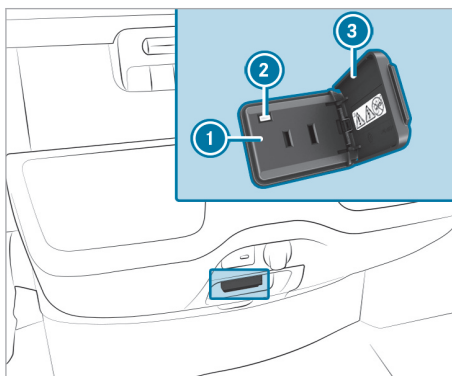

- ▶ Open flap ③.
- ▶ Insert the plug of the device into 115 V socket ①. When the on-board electrical system voltage is sufficient, indicator lamp ② lights up.

If you will not be using the 115 V power socket, keep the flap ③ closed.

Charging a mobile phone using the USB port in the rear passenger compartment

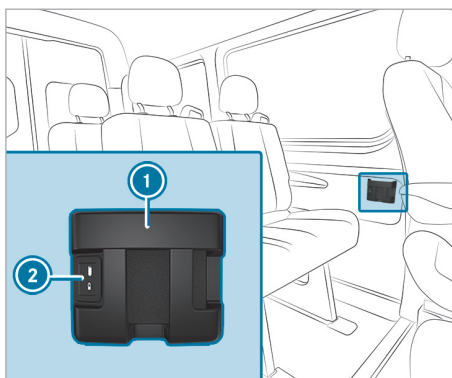

- ▶ Place the mobile phone in storage compartment ① and connect it to USB port ② to charge.

Wirelessly charging the mobile phone and coupling with the exterior antenna

Notes on wirelessly charging the mobile phone

⚠ WARNING Risk of injury due to objects being stowed incorrectly

If objects in the vehicle interior are stowed incorrectly, they can slide or be thrown around and hit vehicle occupants. In addition, cup holders, open storage spaces and mobile phone receptacles cannot always retain all objects within.

There is a risk of injury, particularly in the event of sudden braking or abrupt changes in direction.

- ▶ Always store objects such that they cannot be thrown around in such situations.
- ▶ Always make sure that objects do not protrude from storage spaces, parcel nets or storage nets.
- ▶ Close the lockable storage spaces before starting a journey.
- ▶ Stow and secure objects that are heavy, hard, pointed, sharp-edged, fragile or too large in the cargo compartment.

Comply with the instructions for loading the vehicle (→ page 209).

⚠ WARNING Risk of fire from placing objects in the mobile phone storage compartment

Placing other objects in the mobile phone storage compartment could constitute a fire hazard.

- ▶ Apart from a mobile phone, do not place any other objects in the mobile phone storage compartment, especially those made of metal.

! NOTE Damage to objects caused by placing them in the mobile phone storage compartment

If objects are placed in the mobile phone storage compartment, these may be damaged by electromagnetic fields.

- ▶ Do not place credit cards, storage media, ski passes or other objects sensitive to electromagnetic fields in the mobile phone storage compartment.

! NOTE Damage to the mobile phone stowage compartment caused by liquids

If liquids enter the mobile phone stowage compartment, the compartment may be damaged.

- ▶ Ensure that no liquids enter the mobile phone stowage compartment.

Observe the following notes on wireless charging:

- The charging function is available only when the drive system has been started.
- In some cases, it may not be possible to charge small mobile phones at every position of the mobile phone compartment.
- It may not be possible to charge large mobile phones that do not rest in the mobile phone receptacle.
- The mobile phone can warm up during the charging process. This depends on the applications (apps) currently running.
- For more efficient charging, the protective case should be removed from the mobile phone. Protective cases designed for wireless charging are an exception.
- When charging, the mat should be used if possible.

Charging the mobile phone wirelessly in the front

Requirements:

- The mobile phone must be suitable for wireless charging.

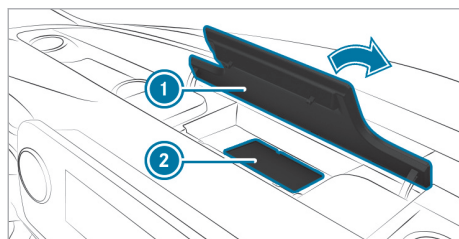

- ▶ Open the flap of stowage compartment ① above the media display.
- ▶ Place the mobile phone as centrally as possible with the display facing upwards on the marked surface of mat ②.
When the charging symbol is shown in the multimedia system, the mobile phone is being charged.

Malfunctions during charging are shown in the media display of the multimedia system.

- ① The mat can be removed for cleaning, e.g. using clean, lukewarm water.

Installing and removing the floor mats

⚠ WARNING Risk of accident due to objects in the driver's footwell

Objects in the driver's footwell may impede pedal travel or block a depressed pedal.

This will jeopardize the operating- and road safety of the vehicle.

- ▶ Stow all objects in the vehicle securely so that they cannot get into the driver's footwell.
- ▶ Make sure that there is always sufficient clearance for the pedals.
- ▶ Always install the floor mats securely and as prescribed.
- ▶ Do not use loose floor mats and do not place floor mats on top of one another.

Installing

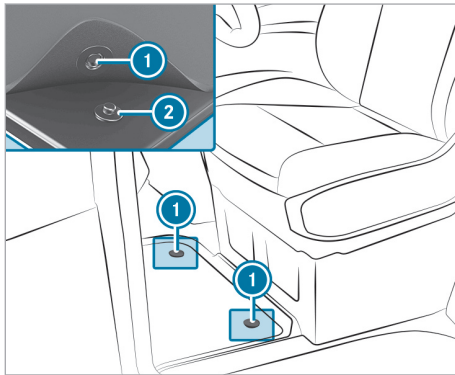

- ▶ Slide the seat backwards.
- ▶ Position the floor mat in the footwell so that it fits flush.
- ▶ Press studs ① onto holders ②, if applicable.
- ▶ Connect the installed driver and passenger footwell floor mats at the contact area.
- ▶ Adjust the seat.

Removing

- ▶ Slide the corresponding seat backwards and pull the floor mat off holders ②, if applicable.
- ▶ Remove the floor mat.

Lighting

Notes on adjusting the lights when driving abroad

Vehicles with halogen or static LED headlamps:

Changing the headlamps is not necessary. The legal requirements will also be fulfilled in countries with left- and right-hand traffic.

Information about lighting systems and your responsibility

The vehicle's various lighting systems are only aids. The vehicle driver is responsible for adjusting the vehicle's lighting to the prevailing light, visibility, statutory conditions and traffic conditions.

Light switch

Operating the light switch

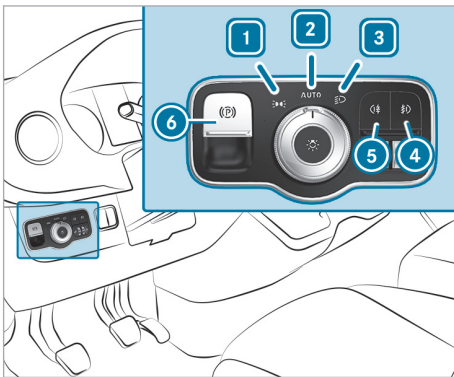

- ▶ **1** Activates or deactivates parking lamps and license plate and instrument lighting.
- ▶ **2** **AUTO** Activates or deactivates automatic driving lights/daytime running lamps (preferred light switch position).
- ▶ **3** Activates or deactivates low beam/high beam.
- ▶ **4** Activates or deactivates the front fog light.
- ▶ **5** Activates or deactivates the rear fog light.
- ▶ **6** Applies or releases the electric parking brake (→ page 141).

i If you hear a warning tone when exiting the vehicle, the lights may still be on.

i The turn signal light, the high beam and the headlamp flasher are operated with the combination switch (→ page 88).

i Leaving the parking lamps on for several hours drains the battery.

If the battery is heavily discharged, the parking lamps will switch off automatically to enable the next vehicle start.

Automatic driving lights function

▲ WARNING Risk of accident when the low beam is switched off in poor visibility

When the light switch is set to **AUTO**, the low beam may not be switched on automatically if there is fog, snow or other causes of poor visibility such as spray.

▶ In such cases, turn the light switch to



The automatic driving lights are only an aid. Responsibility for vehicle lighting rests with you. Turn the light switch from **AUTO** to immediately in the event of fog, snow or spray. Otherwise, the driving lights will be temporarily interrupted.

To switch the automatic driving lights on:

- Turn the light switch to the **AUTO** position. Switch the power supply on: the side lights will automatically switch on or off depending on the brightness of the ambient light.

The daytime running lights will be switched on when the vehicle is started. The side lights and the low beam will also switch on or off depending on the brightness of the ambient light.

When the low beam is switched on, the indicator lamp on the instrument cluster will also switch on.

Activating/deactivating the fog lights

Requirements:

- The light switch is in the or **AUTO** position.
- The vehicle has been switched on or started.

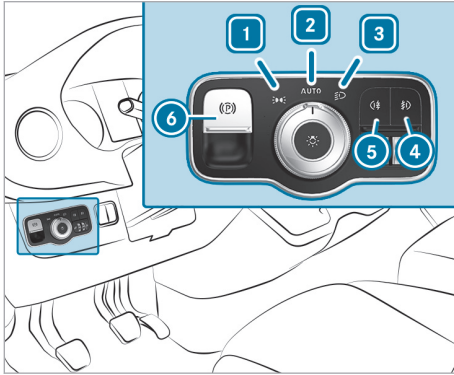

- ▶ **To switch the front fog light on or off:** press button ⑥.
- ▶ **To switch the rear fog light on or off:** press button ⑤.

Comply with the country-specific regulations for using the rear fog lamp.

Operating the combination light switch

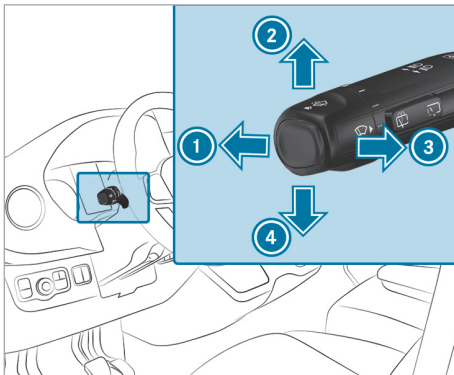

- ① High beam
- ② Right turn signal light
- ③ Headlamp flashing
- ④ Left turn signal light

▶ Use the combination switch to select the desired function.

Switching on high beam

▶ Switch on the low beam (→ page 87).

▶ Push the combination switch forwards ①. The  indicator lamp on the instrument cluster will light up. The combination switch will return to its starting position.

① In the **AUTO** position, the high beam switches on only in darkness and when the vehicle is switched on.

▶ **To switch off:** push the combination switch forwards ① or briefly pull it in the direction of arrow ③ (the action for headlamp flashing switches high beam off). The  indicator lamp on the instrument cluster will go out. The combination switch will return to its starting position.

① **Vehicles with Highbeam Assist:** when Highbeam Assist is active, it controls the activation and deactivation of the high beam (→ page 89).

Headlamp flashing

▶ Briefly pull the combination switch in the direction of arrow ③.

Turn signal light

▶ **To indicate:** push the combination switch in the required direction ② or ④ until it engages. When significant steering movements are made, the combination switch will automatically reset itself.

▶ **To indicate briefly:** tap the combination switch briefly in the required direction ② or ④. The corresponding turn signal lamp will flash three times.

Switching the hazard warning light system on/off

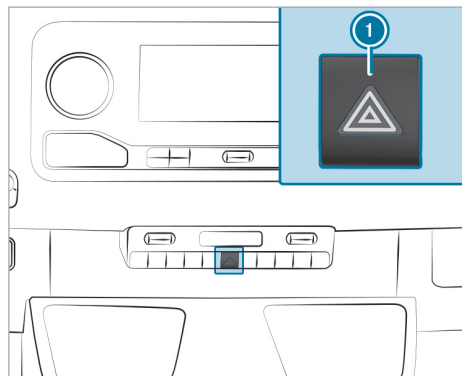

▶ Press button ①.

If you operate a turn signal indicator while the hazard warning light system is switched on, only the turn signal lamps on the relevant side of the vehicle will light up.

- ❗ The hazard warning light system will work even when the vehicle has been switched off.

Cornering light function

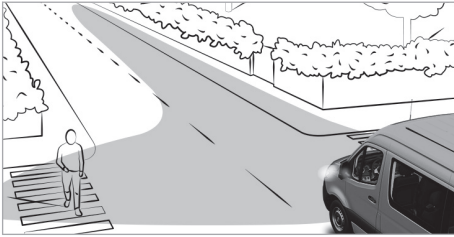

The cornering light improves the illumination of the road over a wide angle in the turning direction, e.g. enabling better visibility in tight bends.

The function is active under the following conditions:

- The speed is less than 37 mph (60 km/h) and the indicator has been switched on or the steering wheel is turned.
- The speed is between 37 mph (60 km/h) and 50 mph (80 km/h) and the steering wheel is turned.

The cornering light may still light up for a short time but will be switched off automatically after a maximum of three minutes.

- ❗ When reverse gear is engaged, the lighting switches to the opposite side.

Highbeam Assist

Adaptive Highbeam Assist function

⚠ WARNING Risk of accident despite Adaptive Highbeam Assist

Adaptive Highbeam Assist does not react to:

- Road users without lights, e.g. pedestrians
- Road users with poor lighting, e.g. cyclists
- Road users whose lighting is obstructed, e.g. by a barrier

On very rare occasions, Adaptive Highbeam Assist may fail to recognize other road users

with their own lighting, or may recognize them too late.

In these, or in similar situations, the automatic high beam will not be deactivated or will be activated despite the presence of other road users.

- ▶ Always observe the road and traffic conditions carefully and switch off the high beam in good time.

Adaptive Highbeam Assist automatically switches between the following settings:

- Low beam
- High beam

The system detects that vehicle lights are approaching in the opposite direction or driving ahead of the vehicle.

At speeds greater than 19 mph (30 km/h), the system will switch to the following setting:

- If no other road users are detected, high beam will switch on automatically.

At speeds lower than 16 mph (25 km/h) or if there is sufficient street lighting, the system will switch to the following setting:

- High beam will automatically switch off.

System limits

Adaptive Highbeam Assist cannot take the road, weather or traffic conditions into consideration.

The detection of obstacles may be restricted if:

- visibility is poor, e.g. in fog, heavy rain or snow.
- the sensors are dirty or obscured.

Adaptive Highbeam Assist is only an aid. You are responsible for ensuring correct vehicle lighting in accordance with the prevailing light, visibility and traffic conditions.

The system's optical sensor is located behind the windshield near the overhead control panel.

Switching Highbeam Assist on/off

Requirements:

- The light switch is in the **AUTO** position.

▶ **To switch on:** switch on high beam using the combination switch.

When the high beam is switched on automatically in the dark, the  indicator lamp will light up on the instrument cluster display.

- ▶ **To switch off:** switch off high beam using the combination switch.

Setting the exterior lighting switch-off delay time

Requirements:

- The light switch is in the **AUTO** position.

Multimedia system:

- ▶ ▶ **Settings** ▶ **Light**
- ▶ **Exterior Lighting Delay**

- ▶ Set a switch-off delay time.

When the vehicle is switched off, the exterior lighting will be activated for the set time.

Activating and deactivating the surround lighting

Multimedia system:

- ▶ ▶ **Settings** ▶ **Light**
- ▶ **Locator Lighting**

- ▶ Activate or deactivate the function.

The surround lighting will remain on for 40 seconds after the vehicle is unlocked. When you start the vehicle, the surround lighting will be deactivated and the automatic driving lights activated.

Adjusting the interior lighting

Adjusting the interior lighting

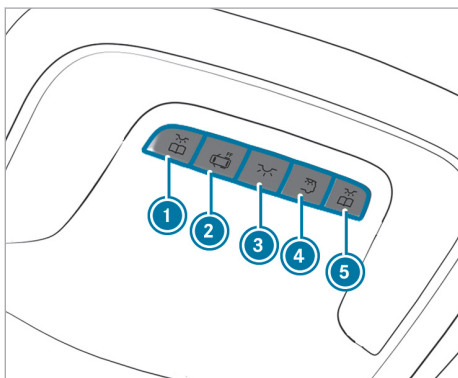

Versions 1 to 4

- ▶ **1** Switches the front-left reading lamp on/off

- ▶ **2** **To switch off the automatic interior lighting control:** press the button.

The interior lighting will switch on automatically if you:

- Unlock the vehicle
- Open a door
- ▶ **3** Switches the (front) interior lighting on/off.
- ▶ **4** Switches the rear passenger compartment / cargo compartment lamp on/off (not assigned depending on the vehicle equipment).
- ▶ **5** Switches the front-right reading lamp on/off

Adjusting the interior lighting for body manufacturer add-on equipment

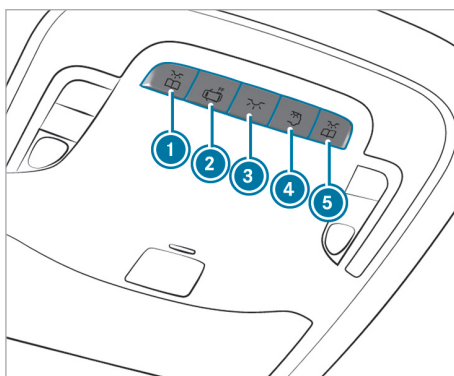

- ▶ **To switch the front left reading lamp on/off:** press button **1**.
- ▶ **To deactivate automatic interior lighting control:** press button **2**. Interior lighting control will switch on automatically if you do the following, for example:
 - Unlock the vehicle
 - Open a door
- ▶ **To switch the front interior lighting on/off:** press button **3**.
- ▶ **To switch body manufacturer lamps on/off:** press button **4** (not assigned depending on the vehicle equipment).
 - Your vehicle may be equipped with a functional feedback system: will light up

in red if the body manufacturer lamps are switched on.

- If the body manufacturer lamps have been switched on manually, they will also remain switched on for an extended period of time after locking.

- ① This period of time is shortened if there is undervoltage in the starter battery.
- ① If the body manufacturer lamps have been switched off automatically to protect the battery, restart the vehicle before switching them on again.
- ① The body manufacturer lamps can be switched on only when the battery voltage is stable.

▶ **To switch the front right reading lamp on/off:** press button ⑥.

Adjusting interior lighting with bus equipment

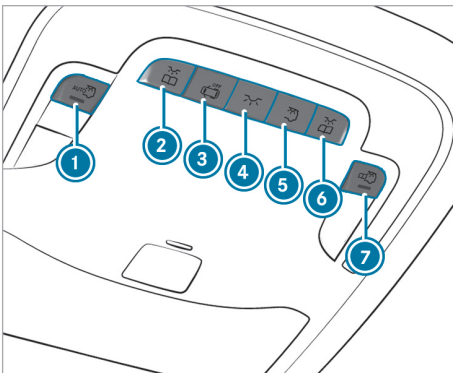

- ① Activates/deactivates the bus function
- ② Switches the front left reading lamp on/off
- ③ Activates/deactivates automatic interior lighting control
- ④ Switches the front interior lighting on/off
- ⑤ Switches passenger compartment lighting on/off
- ⑥ Switches the front right reading lamp on/off
- ⑦ Activates/deactivates reading lighting in the passenger compartment

▶ **To activate the bus function:** press button ①. The LED will light up.

The bus function will be in one of the following modes:

- **Stop mode**

If the vehicle comes to a standstill at a stop, for example, and the passenger door opens, the passenger compartment will be illuminated (undimmed).

- **Driving mode**

If all doors are closed and the vehicle is traveling faster than walking pace, the passenger compartment will be illuminated (dimmed).

- **Automatic off mode**

If automatic interior lighting control ③ is deactivated, thereby activating automatic off mode, the passenger compartment will be continuously illuminated (dimmed).

When the bus function is activated, the modes can be selected via button ⑤ that switches passenger compartment lighting on/off. Passenger compartment lighting will then be deactivated completely. When button ⑤ is pressed again to switch passenger compartment lighting on/off, the bus function will again be in one of the modes.

- If automatic interior lighting control ③ was previously activated, automatic off mode will be inactive again.
- If automatic off mode was not previously activated, either driving or stop mode will be active.
- ① The bus function can be operated independently of button ⑤ that switches passenger compartment lighting on/off. The passenger compartment lighting must not be switched on beforehand.

▶ **To deactivate the bus function:** press button ①. The LED will not light up.

▶ **To switch the front left reading lamp on/off:** press button ②.

▶ **To deactivate automatic interior lighting control:** press button ③. Interior lighting control will switch on automatically if you do the following, for example:

- Unlock the vehicle
- Open a door

▶ **To switch the front interior lighting on/off:** press button ④.

▶ **To switch passenger compartment lighting on or off:** press button ⑤.

▶ **To switch the front right reading lamp on/off:** press button ⑥.

▶ **To activate reading lighting in the passenger compartment:** press button ⑦.
The LED will light up.

Passengers will be able to switch the reading lamps on and off.

▶ **To deactivate reading lighting in the passenger compartment:** press button ⑦.
The LED will not light up.

Passengers will no longer be able to operate the reading lamps.

Switching the reading lamp above the passenger seat on and off (bus equipment)

▶ Press the  button above the passenger seat.

Switching the rear passenger compartment interior lighting on/off

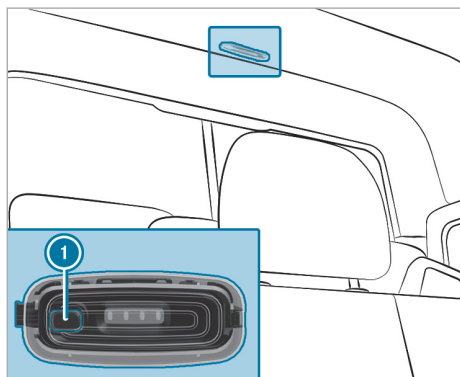

▶ ① Switches rear passenger compartment/cargo compartment lamp on or off

Motion detector

⚠ WARNING Risk of injury due to laser beam of the motion detector

The motion detector emits non-visible radiation from LEDs that are classified as class 1M lasers.

This may damage the retina in the following situations:

- If you look directly into the unfiltered laser beam of the motion detector for an extended period.
- If you look directly into the laser beam of the motion detector with optical instruments, such as glasses or magnifying glasses.

▶ Never look directly into the motion detector.

The motion detector is located in the cargo compartment behind the partition, in the middle of the roof.

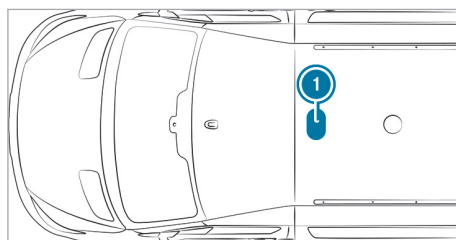

① Position of motion detector

If the vehicle is equipped with a motion detector, the cargo compartment lamp is also activated via the motion detector.

If the motion detector detects movement in the cargo compartment while the vehicle is stationary, the cargo compartment lamp will switch on for approximately two minutes.

The cargo compartment lamp will be switched on via the motion detector in the following situations:

- The vehicle is stationary, the parking brake is applied and you are not depressing the brake pedal.
- **Vehicles with automatic transmission:** the selector lever is in position **P** and you are not depressing the brake pedal.
- The vehicle has not been locked from the outside using the key.

If no change to the vehicle (e.g. a door opening) is detected over several hours, the motion detector will automatically switch off. This prevents the battery from discharging.

Switching the interior lighting switch-off delay time on/off

Multimedia system:

→ [Home] ▶ Settings ▶ Light
▶ Interior Lighting Delay

- ▶ Switch the switch-off delay time on or off. If the function is active, the interior lighting will switch on automatically when the vehicle is unlocked or switched off.

Changing bulbs

Instructions for replacing illuminants

⚠ WARNING Risk of burns from hot component parts whilst replacing a bulb

Bulbs, lamps and plug connectors can become very hot during operation.

When replacing a bulb, you could burn yourself on these component parts.

- ▶ Allow the component parts to cool down before replacing the bulbs.

Important safety notes

- Before changing the bulbs, switch off the vehicle's lighting system. This will prevent a short circuit.
- Use only spare bulbs of the same type and with the correct voltage.
- Use bulbs only in enclosed lamps that have been designed for them.
- Do not use any illuminant that has been dropped or has scratches on its glass tube. Otherwise, the illuminant may explode.
- The illuminant may explode under the following conditions:
 - if it is hot and you touch it
 - if you drop it
 - if you scratch it
- Stains on the glass tube will reduce the service life of the illuminant. Do not touch the glass tube with your bare hands. If necessary, clean the glass tube with alcohol or spirits while it is cold and wipe it down with a lint-free cloth.
- Protect light bulbs from humidity and do not bring them into contact with liquids.

Always ensure the bulbs are firmly secured.

If your vehicle is equipped with LED modules, you can check this as follows: the light cone will move

from top to bottom and back again when the vehicle starts. For this to work, low beam needs to have been switched on before the vehicle is started.

Bulbs and lamps are major elements in vehicle safety. Therefore, ensure that they are always working. Have the headlamp setting checked regularly.

If the new light source also does not light up, consult a qualified specialist workshop.

Replacing front light bulbs (vehicles with halogen headlamps)

Overview of illuminant types

You can replace the following light sources.

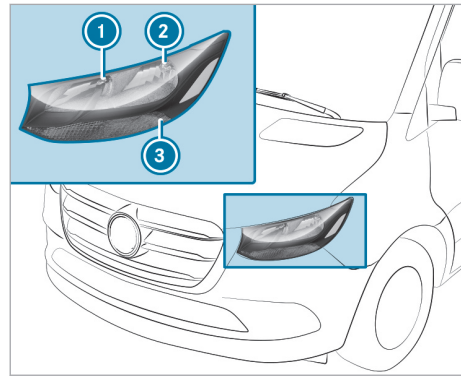

Halogen headlamps

- ① High beam/daytime running lights: H15 55 W/15 W
- ② Low beam/perimeter light: H7 55 W/W 5 W
- ③ Turn signal light: 3457 NAK 28 W

Replacing halogen headlamps

Requirements

- **Low beam:** light source type H7 55 W
- **High beam/daytime running lights:** light source type H15 55 W/15 W
- **Perimeter lights:** light source type W 5 W
- **Turn signal lights:** light source type 3457 NAK 28 W

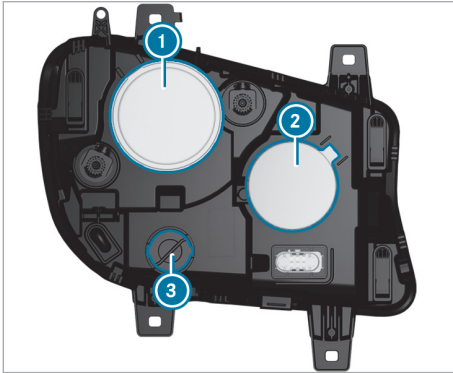

- ① Low beam/perimeter light housing cover
- ② High beam/daytime running lights housing cover
- ③ Turn signal light socket

▶ Switch off the lighting system.

▶ **Low beam/perimeter light:** pull housing cover ① rearward to remove it.

▶ Pull the socket rearward to remove it.

▶ Remove the light source from the socket.

▶ Insert the new light source into the socket such that the base of the bulb rests fully against the base of the socket.

▶ Align and insert the socket.

▶ Attach housing cover ①.

▶ **High beam/daytime running lights:** pull housing cover ② rearward to remove it.

▶ Turn the socket counter-clockwise and pull it out.

▶ Remove the light source from the socket.

▶ Insert the new light source into the socket such that the base of the bulb rests fully against the base of the socket.

▶ Insert the socket and turn it clockwise.

▶ Attach housing cover ②.

▶ **Turn signal light:**

▶ Turn socket ③ counter-clockwise and remove it.

▶ Gently turn the illuminant counter-clockwise and take it out of the socket.

▶ Insert the new illuminant into the socket and turn it clockwise.

▶ Insert socket ③ and turn it clockwise.

Additional turn signal light

Requirements:

- **Additional turn signal light (all-wheel drive vehicles):** bulb type P 21 W

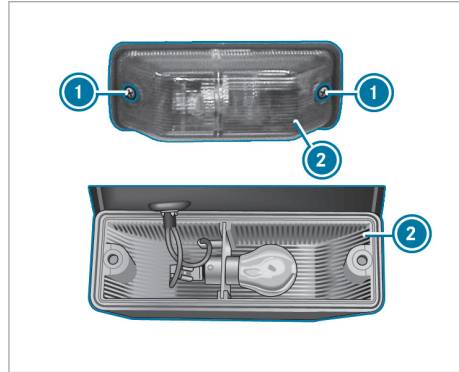

▶ Switch off the lighting system.

▶ Unscrew screws ① and remove light lens ②.

▶ Gently turn the light source counter-clockwise and take it out of the socket.

▶ Insert the new light source into the socket and turn it clockwise.

▶ Position light lens ② and tighten screws ①.

Replacing rear illuminants (Cargo Van and Passenger Van)

Overview of rear illuminant types (Cargo Van and Passenger Van)

You can replace the following light sources.

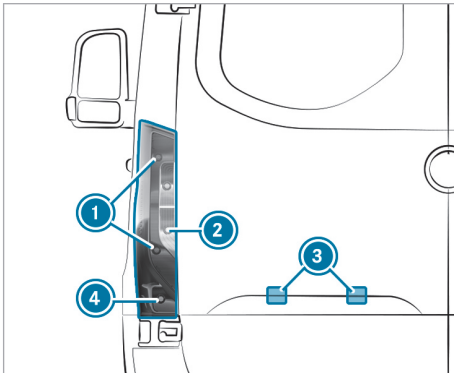

Vehicles with standard tail lamps

- ① Brake lights/tail lamps/perimeter lights: P 21 W
- ② Reversing lamp: P 21 W
- ③ License plate lamp: W 5 W
- ④ Rear fog light: P 21 W

You can replace the following light sources.

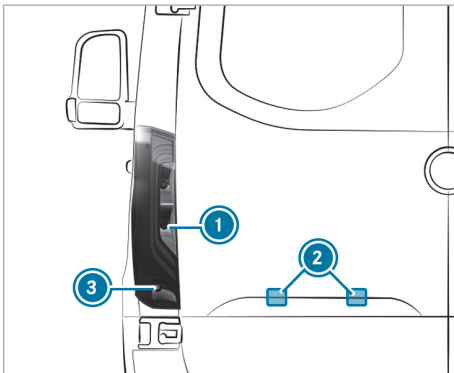

Vehicles with partial LED tail lamps

- ① Reversing lamp: P 21 W
- ② License plate lamp: W 5 W
- ③ Rear fog light: P 21 W

■ Changing the tail lamps (Cargo Van and Passenger Van)

Requirements:

- **Brake lights/tail lights/perimeter lights:** illuminant type P 21 W
- **Reversing lamps:** illuminant type P 21 W
- **Rear fog lights:** illuminant type P 21 W

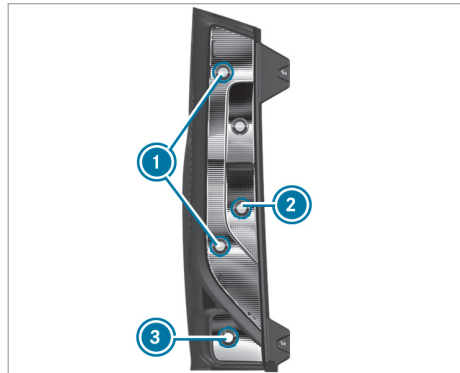

- ① Brake light/tail light/perimeter light
- ② Reversing lamp
- ③ Rear fog light

- ▶ Switch off the lighting system.
- ▶ Open the rear-end door.

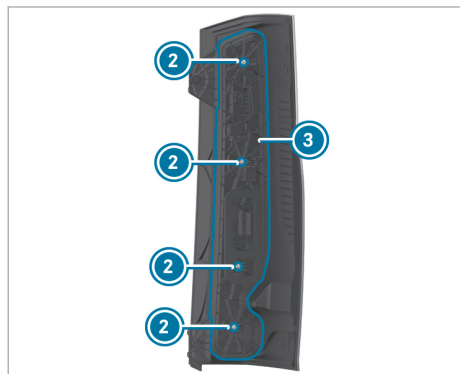
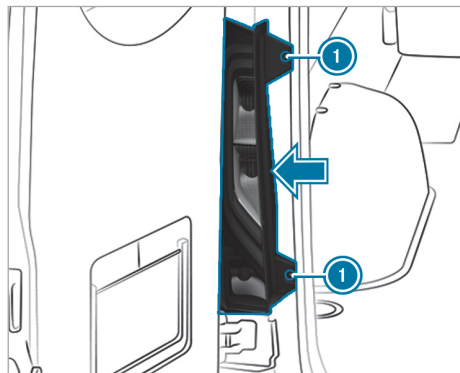

- ▶ **To remove:** loosen screws ❶ and pull out the tail lamp in the direction of the arrow.
- ▶ Remove the plug from bulb mount ❸.
- ▶ Loosen screws ❷ and remove bulb mount ❸ from the tail lamp.
- ▶ Gently turn the illuminant counter-clockwise and take it out of the socket.
- ▶ Insert the new illuminant into the socket and turn it clockwise.
- ▶ **To install:** set bulb mount ❸ on the tail lamp and screw in screws ❷.
- ▶ Press the plug into bulb mount ❸.
- ▶ Insert the tail lamp and screw in screws ❶.

■ License plate lamp

Requirements:

- **License plate lamp:** light bulb type W 5 W

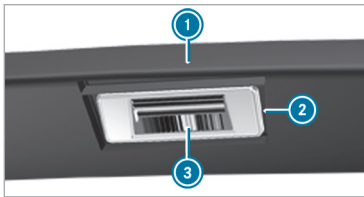

- ▶ Switch off the lighting system.
- ▶ Place a screwdriver, for example, at opening ❷ between lamp ❸ and panel ❶ and carefully pry off the lamp ❸.
- ▶ Remove lamp ❸ from panel ❶.
- ▶ Rotate the bulb holder by around 45° and detach it from the lamp.
- ▶ Remove the light bulb.
- ▶ Insert the new bulb into the bulb holder.
- ▶ Insert the bulb holder into the lamp and rotate it by around 45°.
- ▶ Insert the lamp into the panel opening until it engages.

Replacing rear illuminants (chassis)

■ Overview of rear light source types (chassis)

You can replace the following light sources.

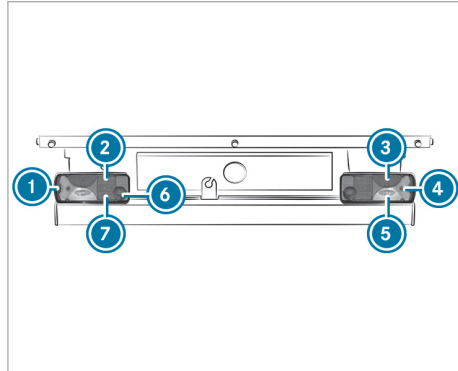

Vehicles with standard tail lamps

- ❶ Clearance lamp: R 5 W
- ❷ Tail light: R 5 W
- ❸ Brake light: P 21 W
- ❹ Turn signal light: PY 21 W
- ❺ Backup lamp: P 21 W
- ❻ Rear fog light (driver's side): P 21 W
- ❼ License plate lamp: R 5 W

■ Replacing the tail lamps on the chassis

Requirements:

- **Rear fog lights:** light source type P 21 W
- **License plate lamp:** light source type R 5 W
- **Backup lamp:** light source type P 21 W
- **Turn signal lights:** light source type PY 21 W
- **Clearance lamps:** light source type R 5 W
- **Brake lights:** light source type P 21 W
- **Tail lights:** light source type R 5 W

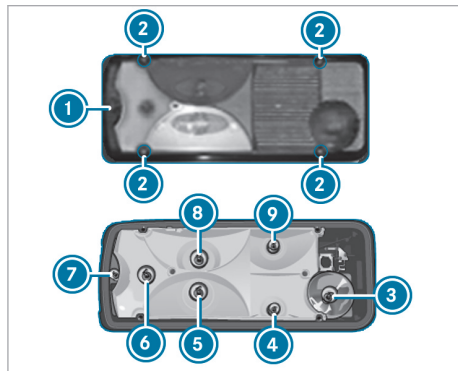

- ❶ Light lens
- ❷ Screws

- ③ Rear fog light
- ④ License plate lamp
- ⑤ Backup lamp
- ⑥ Turn signal light
- ⑦ Clearance lamp
- ⑧ Brake light
- ⑨ Tail light

- ▶ Switch off the lighting system.
- ▶ Unscrew screws ② and remove light lens ①.
- ▶ Remove the plug from the bulb mount.
- ▶ Gently turn the light source counter-clockwise and take it out of the socket.
- ▶ Insert the new light source into the socket and turn it clockwise.
- ▶ Position light lens ① and tighten screws ②.

Replacing interior light bulbs

Replacing rear interior lamps

Requirements

- ① For the standard bulb failure indicator function to work correctly, only light bulbs that are the same type and power as those installed during production may be used.

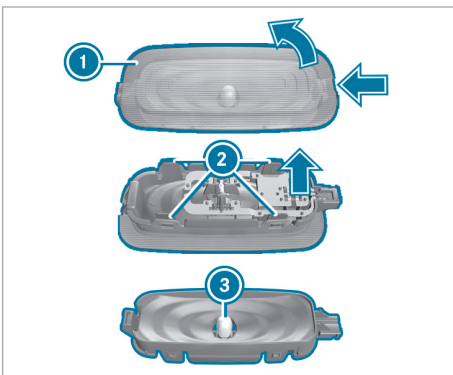

- ▶ Switch off the interior lighting.
- ▶ Press in the catch spring of lens ① with a suitable object, e.g. a screwdriver, and then lever off the lens with the lamp housing.
- ▶ **To remove the lens from the lamp housing:** press the lugs of lens ② inwards.
- ▶ Remove light bulbs ③ from the lamp housing.
- ▶ Insert the new light bulb.

- ▶ Position the lens on the lamp housing and engage it.
- ▶ Align the lens with the lamp housing and engage it.

Windshield wipers

Switching the windshield wipers on and off

Requirements:

- The power supply is switched on.

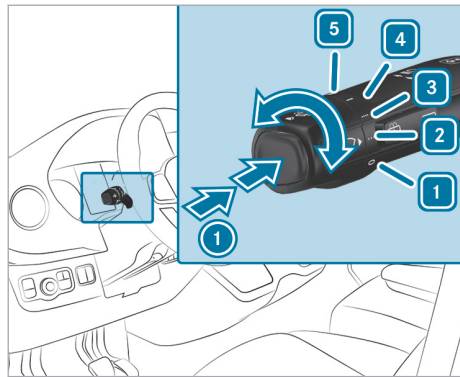



- ① Single wipe/wiping with washer fluid
- 1 0 Windshield wipers off
- 2 Intermittent wiping, normal
Vehicles with rain sensors: automatic wiping, normal
- 3 Intermittent wiping, frequent
Vehicles with rain sensors: automatic wiping, frequent
- 4 Continuous wiping, slow
- 5 Continuous wiping, fast

- ▶ Turn the combination switch to the corresponding position 1 - 5.
- ▶ **Single wipe:** press button ① on the combination switch in the direction of arrow as far as the first pressure point.
- ▶ **Washing:** press button ① on the combination switch in the direction of arrow as far as the second pressure point.

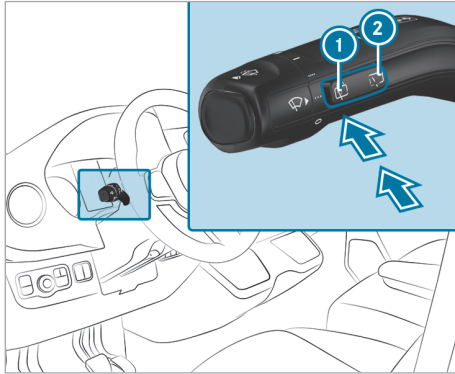
Switching the rear window wiper on and off



- ①  Single wipe/wash
- ②  Intermittent wiping

- ▶ **Single wipe:** press button ① to the pressure point.
- ▶ **Wiping with washer fluid:** press button ① beyond the pressure point.
- ▶ **To switch intermittent wiping on or off:** press button ②.
The  symbol will appear on the instrument cluster when the rear window wiper is switched on.

Replacing the windshield wiper blades

⚠ WARNING Risk of becoming trapped if the windshield wipers are switched on while wiper blades are being replaced

If the windshield wipers begin to move while you are changing the wiper blades, you can be trapped by the wiper arm.

- ▶ Always switch off the windshield wipers and vehicle before changing the wiper blades.

⚠ WARNING Risk of injury from using the windshield wipers when the hood is open

If the windshield wipers start moving when the hood is open, you could be trapped by the wiper linkage.

- ▶ Always switch off the windshield wipers and vehicle before opening the hood.

Replacing the wiper blades

- ① If the wiper blades are worn out, they will no longer wipe the windshield properly. Replace the wiper blades twice a year, preferably in spring and fall.

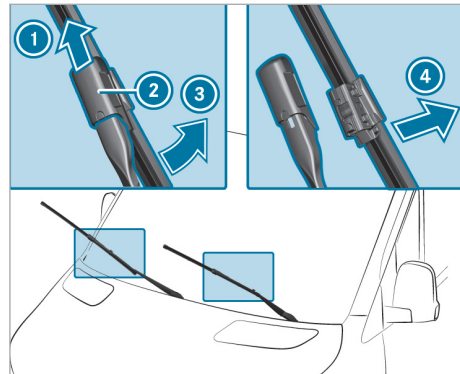

- ▶ Fold wiper arm ③ away from the windshield.
- ▶ Hold wiper arm ③ and turn the wiper blade away from wiper arm ③ in the direction of the arrow as far as it will go.
- ▶ Slide catch ② upwards in the direction of the arrow until it engages.
- ▶ Fold the wiper blade back onto the wiper arm.
- ▶ Remove the wiper blade ① from the wiper arm.
- ▶ Insert new wiper blade ① in the holder on wiper arm ③.

When doing so, take into account the different lengths of the wiper blades:

- Driver's side: long wiper blade
- Front passenger side: short wiper blade
- ▶ Slide catch ② downwards until it engages.
- ▶ Fold wiper arm ③ back onto the windshield.

Replacing the windshield wiper blades (WET WIPER SYSTEM)

⚠ WARNING Risk of becoming trapped if the windshield wipers are switched on while wiper blades are being replaced

If the windshield wipers begin to move while you are changing the wiper blades, you can be trapped by the wiper arm.

- ▶ Always switch off the windshield wipers and vehicle before changing the wiper blades.

⚠ WARNING Risk of injury from using the windshield wipers when the hood is open

If the windshield wipers start moving when the hood is open, you could be trapped by the wiper linkage.

- ▶ Always switch off the windshield wipers and vehicle before opening the hood.

Replacing the wiper blades

- i** If the wiper blades are worn out, they will no longer wipe the windshield properly. Replace the wiper blades twice a year, preferably in spring and fall.

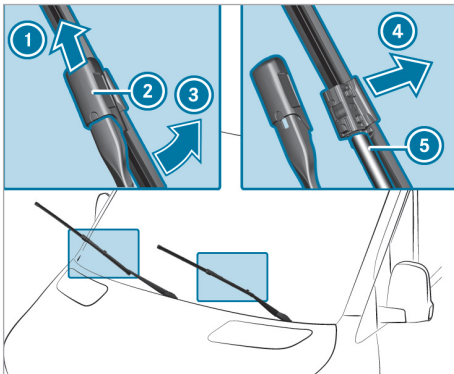

- ▶ Fold wiper arm **3** away from the windshield.
- ▶ Hold wiper arm **3** and turn the wiper blade away from wiper arm **3** in the direction of the arrow as far as it will go.
- ▶ Slide catch **2** upwards in the direction of the arrow until it engages.
- ▶ Remove wiper blade **1** from the wiper arm in the direction of arrow **4**.
- ▶ Carefully remove hose **5** from the wiper blade.
- ▶ Attach hose **5** to the new wiper blade.
- ▶ Insert new wiper blade **1** in the holder on wiper arm **3**.

When doing so, take into account the different lengths of the wiper blades:

- Driver's side: long wiper blade
- Front passenger side: short wiper blade

- ▶ Slide catch **2** downwards until it engages.
- ▶ Fold the wiper blade back onto the wiper arm.
- ▶ Fold wiper arm **3** back onto the windshield.

Replacing the rear window wiper blades

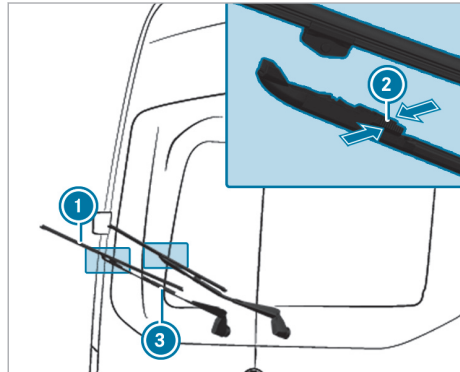

- ▶ Fold wiper arm **3** away from the rear window.
- ▶ Press both retaining clips **2** together in the direction of the arrow and swivel the wiper blade away from the wiper arm.
- ▶ Pull wiper blade **1** upwards out of the holder on wiper arm **3**.
- ▶ Insert new wiper blade **1** in the holder on wiper arm **3**.
- ▶ Push new wiper blade **1** onto wiper arm **3** until the retaining clips engage.
- ▶ Fold wiper arm **3** back onto the rear window.

Mirrors

Operating the outside mirrors

⚠ WARNING Risk of accident due to adjusting the vehicle settings while the vehicle is in motion

You could lose control of the vehicle in the following situations in particular:

- If you adjust the driver's seat, the head restraint, the steering wheel or the mirror while the vehicle is in motion
- If you fasten your seat belt while the vehicle is in motion

- ▶ Before starting the vehicle: in particular, adjust the driver's seat, head restraint,

steering wheel and mirror, and fasten your seat belt.

⚠ WARNING Risk of accident due to misjudgment of distance when using the front-passenger mirror

The outside mirror on the front passenger side reflects objects on a smaller scale. The objects in view are in fact closer than they appear.

▶ Therefore, always look over your shoulder to check the actual distance between you and the road users traveling behind you.

Adjusting the outside mirrors manually

- ▶ Adjust the outside mirrors to the correct position manually.
- ▶ **To engage an outside mirror that has been pushed out of position:** push the outside mirror into position manually.

Adjusting the outside mirrors electrically

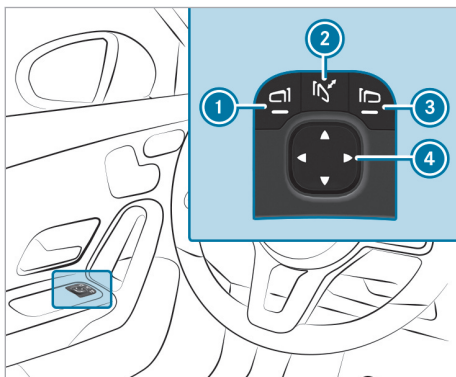

Example image

! **NOTE** Damage to the electric outside mirrors due to folding in by hand or by force

If the electric outside mirrors are folded in or out manually, the outside mirrors may be damaged and will not engage properly.

If the outside mirrors are not folded when you have the vehicle washed at an automatic car wash, the washing brushes may forcibly fold in and damage the outside mirrors.

▶ Fold the outside mirrors in and out electrically only.

▶ Fold in the outside mirrors before having the vehicle washed at an automatic car wash.

- ▶ Before setting off, switch on the power supply or the vehicle.
- ▶ **To fold in or out:** briefly press button ②.
- ▶ **To select:** use button ① or ③ to select the outside mirror to be adjusted.
- ▶ **To adjust:** use button ④ to set the position of the mirror glass.
- ▶ **To engage an outside mirror that has been pushed out of position:** press and hold button ②.
You will hear a click and the mirror will audibly engage in position. The outside mirror will be set to the correct position.

Resetting the outside mirrors

- ① If the battery has been disconnected or completely discharged, the outside mirrors must be reset. Only then will the automatic mirror folding function work properly.
- ▶ Switch on the power supply or the vehicle.
- ▶ Briefly press button ②.

Heating the outside mirrors

- ▶ **Vehicles without a rear window heater:** at low temperatures, the mirror heater will switch on automatically once the vehicle has been started.
- ▶ **Vehicles with a rear window heater:** at low temperatures, the mirror heater will switch on automatically once the vehicle has been started. The mirror heater can also be switched on together with the rear window heater using the rear window heater button.

Using the digital inside rearview mirror

The vehicle may be equipped with a digital inside rearview mirror. This uses a rear-mounted camera on top of the roof to provide a better view to the rear. The inside rearview mirror can be used either as a standard inside rearview mirror or as a display.

To prevent glare from the digital inside rearview mirror, first set the digital inside rearview mirror as the standard inside rearview mirror.

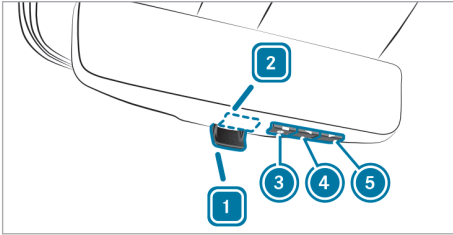

Digital image noise may occur on the display under certain circumstances in unfavorable ambient light.

Certain types of sunlight, e.g. sun low on the horizon or light from another intense light source, can reduce the display's contrast and cause it to become too bright. In such situations, objects on the display may be obscured or difficult to see. In these cases, be particularly careful and adapt your driving style accordingly.

Drivers must always wear the necessary personal visual aids required for them to drive a vehicle. Drivers with presbyopia (age-related long-sightedness) should, if necessary, wear visual aids with multifocal lenses to be sufficiently able to see traffic including via the displays.

- ❗ If the camera on top of the roof at the rear is dirty, the image may be impaired. In this case, clean the camera manually with a damp cloth. Observe the notes on cleaning the digital inside rearview mirror (→ page 224).

- ▶ **To use the standard inside rearview mirror:** move the switch to position **1**.
- ▶ **To use the display:** move the switch to position **2**.

Adjusting the display brightness

- ❗ The digital inside rearview mirror is equipped with light sensors on the front and back and automatically adjusts the brightness of the display to the ambient light. Do not cover the light sensors, e.g. with a sticker.
 - ▶ Press menu button **3** once.
 - ▶ Press button **4** to reduce the display brightness.
- or
- ▶ Press button **5** to increase the display brightness.

Adjusting the angle of the camera

- ▶ Press menu button **3** twice.

- ▶ Press button **4** to move the angle downwards.
- or
- ▶ Press button **5** to move the angle upwards.

Activating and deactivating the rear view camera image

The vehicle may be equipped with a rear view camera with image in the inside rearview mirror.

- ▶ To activate, put the vehicle in reverse gear or press button **5**.
- ▶ To deactivate, take the vehicle out of reverse gear or press button **5** again.

Error mode of the digital inside rearview mirror

If a system error occurs, e.g. if the camera fails, a crossed-out camera will appear at the top left of the display and no camera image will be visible in the mirror.

- ▶ Switch to the standard inside rearview mirror if there is a system error.

If the vehicle is equipped with a rear view camera with image in the inside rearview mirror and a system error occurs, a crossed out camera with the number 2 will appear on the left side of the display. In this case, no camera image is available for maneuvering.

Dimming the inside rearview mirror

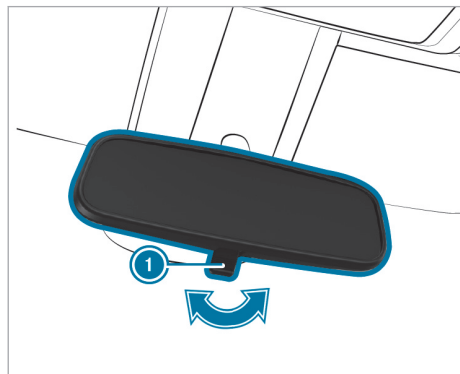



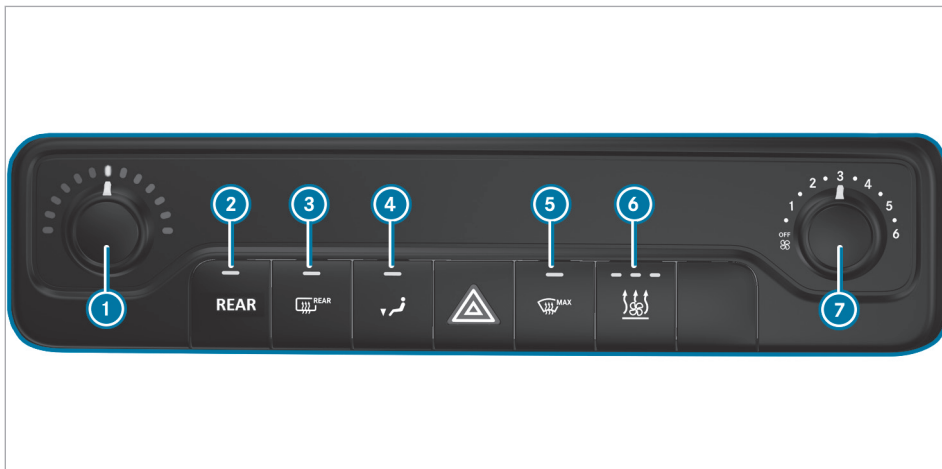

- ▶ Fold anti-glare lever **1** in the direction of the arrow.

Overview of climate control systems

Heating system overview



- ① Sets the temperature
- ②  Switches the rear passenger compartment heating on/off
- ③  Switches the rear window defroster on/off (→ page 107)
- ④  Switches footwell air distribution on/off
- ⑤  Switches windshield defrosting on/off (→ page 106)
- ⑥ Vehicles with stationary heaters or heater boosters:  switches the stationary heater or heater booster on/off
- ⑦ Sets the airflow
- ① The indicator lamps on the buttons signal that the functions in question have been activated.

TEMPMATIC overview

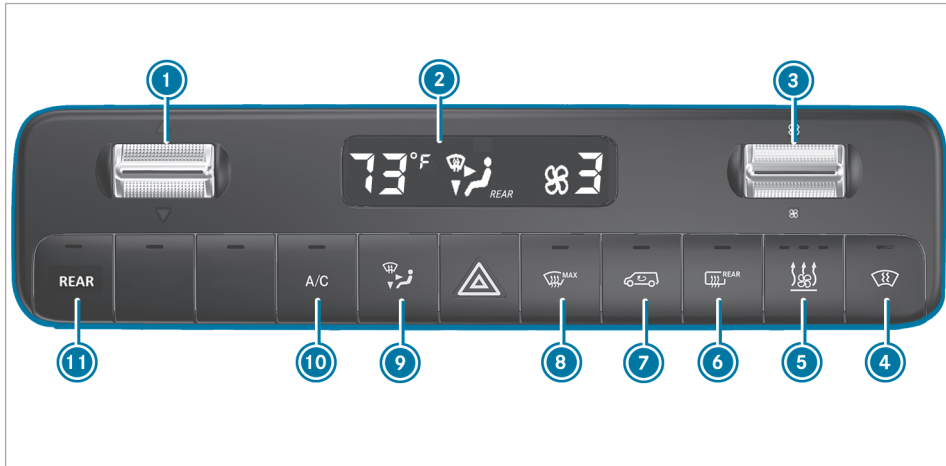

- ① Sets the temperature
 - ② Display
 - ③ Sets the airflow
 - ④ Vehicles with windshield heater: switches the windshield heater on/off (→ page 107)
 - ⑤ Vehicles with stationary heaters or booster heaters: switches the stationary heater or booster heater on/off
 - ⑥ Vehicles with rear window defrosters: switches the rear window defroster on/off (→ page 107)
 - ⑦ Switches air-recirculation mode on/off (→ page 106)
 - ⑧ Switches windshield defrosting on/off (→ page 106)
 - ⑨ Sets the air distribution (→ page 106)
 - ⑩ Switches the A/C function on/off (→ page 105)
 - ⑪ Vehicles with dual-zone climate control systems: adjusts the rear passenger compartment climate control/heating (indicator lamp flashes) (→ page 104)
- ⓘ The indicator lamps on the buttons signal that the functions in question have been activated.

THERMOTRONIC overview

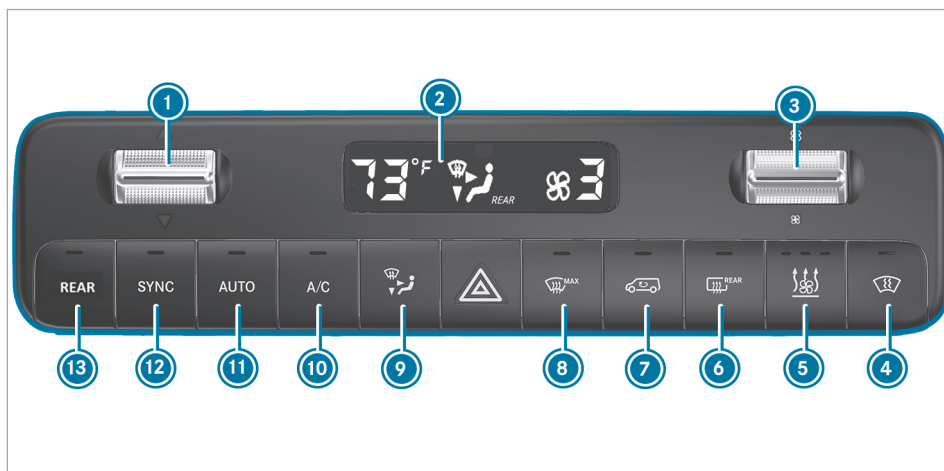

- 1 Sets the temperature
 - 2 Display
 - 3 Sets the airflow
 - 4 Vehicles with windshield heater: switches the windshield heater on/off (→ page 107)
 - 5 Vehicles with stationary heaters or booster heaters: switches the stationary heater or booster heater on/off
 - 6 Vehicles with rear window defrosters: switches the rear window defroster on/off (→ page 107)
 - 7 Switches air-recirculation mode on/off (→ page 106)
 - 8 Switches windshield defrosting on/off (→ page 106)
 - 9 Sets the air distribution (→ page 106)
 - 10 Switches the A/C function on/off (→ page 105)
 - 11 Sets climate control to automatic mode, front (→ page 105) and rear (→ page 105)
 - 12 Activates/deactivates synchronization (→ page 106)
 - 13 Vehicles with dual-zone climate control systems: adjusts the rear passenger compartment climate control/heating (indicator lamp flashes) (→ page 104)
- i The indicator lamps on the buttons signal that the functions in question have been activated.

Operating climate control systems

Switching the climate control system on/off

- ▶ **To switch on:** set the airflow to 1 or higher on the front-compartment menu.
 - ▶ **To switch off:** set the airflow to 0 or OFF on the front-compartment menu. OFF will appear on the climate control system display.
- i When the climate control system is switched off, the windows may fog up more quickly. Switch the climate control system off only briefly.
- i If the front-compartment system has already been switched on and the rear-compartment system has been switched off, you can switch it on by turning up the blower on the rear-compartment menu. If the front-compartment system is switched on, the rear-compartment system will automatically switch on as well.

Setting the rear-compartment climate control



Requirements:

- The climate control system has been switched on (→ page 104).

Setting the temperature and airflow with TEMP-MATIC and THERMOTRONIC:

- ▶ Press the **REAR** button. The indicator lamp on the **REAR** button and the **REAR** symbol on the climate control system display will flash.

The display will switch to the temperature and the blower on the rear menu.



- ▶ Use the  and  rocker switches to set the required temperature and airflow on the rear-compartment menu.

- ⓘ If there are significant differences between the temperature settings of the front and rear systems, these cannot be regulated accurately.
- ⓘ If the rear-compartment climate control has been switched off, you can switch it on automatically by pressing the  button.

Depending on the vehicle equipment, climate control will switch on the roof-mounted air-conditioning system or rear-compartment heating as required:

- **Vehicles with a roof-mounted air-conditioning system:** the rear passenger compartment can only be cooled.
- **Vehicles with rear-compartment heating:** the rear passenger compartment can only be heated.

Switching off rear-compartment climate control via TEMPOMATIC and THERMOTRONIC:

- ▶ Press the  button.
- ▶ If the indicator lamp on the  button and the  symbol on the climate control system display flash, set the airflow to 0 on the rear-compartment menu.

- ⓘ Indicator lamp on: rear-compartment climate control has been switched on.
Indicator lamp off: rear-compartment climate control has been switched off.
Indicator lamp flashes: the setting mode of the rear-compartment climate control is active.

Switching the A/C function on/off

Requirements:

- The climate control system has been switched on (→ page 104).

The A/C function controls the climate and dries the air inside the vehicle.

- ▶ Press the  button.
- ⓘ Switch off the A/C function only briefly. Otherwise, the windows could fog up more quickly.
- ⓘ Condensation may leak from the underside of the vehicle in cooling mode. This is not a sign of a defect.

Automatically regulating climate control

Requirements:



- The climate control system has been switched on (→ page 104).

Switching on automatic climate control

In automatic mode, the temperature, airflow and air distribution are regulated and kept constant.

- ▶ Press the  button.
The display will show the temperature. The airflow and air distribution will disappear from the display.

Switching off automatic climate control



- ▶ Use the  rocker switch to change the airflow setting or the  button to change the air distribution (→ page 106).
The other setting will remain unaffected by the change.

Automatically controlling climate control in the rear passenger compartment

Requirements:

- Rear passenger compartment climate control has been switched on (→ page 104).

In automatic mode, the temperature, airflow and air distribution are regulated and kept constant.



- ▶ Press the  button.
- ▶ Press the  button.
- ⓘ Even if the front compartment system is in automatic mode, the rear passenger compartment system can exit automatic mode if you adjust the blower in the rear passenger compartment menu.



- ⓘ If the air is cooled and the driver's, front passenger or sliding door is opened, the blower of the rear passenger compartment air conditioning system will be turned down after around 15 minutes.
When all doors have been closed again, the blower will be reset to the previous setting after around one minute.

Information on the air distribution settings







The symbols on the display indicate the vents through which the air is being directed.

TEMPOMATIC

-  Defroster and center air vent
-  All vents

-  Center vents
-  Center and footwell vents

THERMOTRONIC

-  Defroster vent
-  Defroster and center air vent
-  All vents
-  Defroster and footwell vents
-  Center vents
-  Center and footwell vents
-  Footwell vents

Setting the air distribution

Requirements:

- The climate control system is switched on.
- ▶ Press the  button repeatedly until the desired air distribution appears in the air conditioning system display.

Switching the synchronization function on/off

Requirements:

- The climate control system has been switched on (→ page 104).

The synchronization function controls the climate control function centrally. The settings for the temperature and airflow in the front zone will automatically be adopted for the rear zone.



- ▶ Press the **SYNC** button.
- i** If the rear passenger compartment climate control has been switched off, you can switch it on automatically by pressing the **SYNC** button.



Defrosting the windows

Windows fogged up on the inside Vehicles with heating system







- ▶ Press the  button.
When windshield defrosting is switched on, the temperature and airflow cannot be adjusted.
- ▶ Close the front air vents (→ page 107).

Vehicles with TEMPMATIC or THERMOTRONIC

- ▶ Press the **A/C** button and, if necessary, use the  button to direct air onto the windshield .

- ▶ Increase the airflow as necessary and close the front air vents (→ page 107).
- ▶ If the windows remain fogged up: press the  button.
When windshield defrosting is switched on, the temperature and airflow cannot be adjusted.
 will appear on the climate control system display.
- ▶ **Vehicles with a windshield heater:** press the  button.

Depending on operation, you can achieve faster defrosting and drying of the windshield with the following settings:

- Use the  button to direct air onto the windshield .
- Set the temperature  and the airflow  to maximum using the rocker switches.
- Close the front air vents (→ page 107).
- Vehicles with windshield heater: switch on the  windshield heater (→ page 107).
- Switch off the **REAR** rear climate control (→ page 104).
- For vehicles with heating systems: set the air distribution so that the  and  LEDs are off (→ page 102).

Windows fogged up on the outside

- ▶ Switch on the windshield wiper (→ page 97).

Switching air-recirculation mode on/off

- ▶ Press the  button.
The interior air will be recirculated.

Air-recirculation mode will switch off automatically.

- i** When air-recirculation mode is switched on, the windows may fog up more quickly. Switch on air-recirculation mode only briefly.

Air-recirculation mode will automatically switch on in the following cases:

- in high outside temperatures
- while the vehicle is driving through a tunnel (vehicles with THERMOTRONIC automatic climate control and navigation only)
- when the wiping with washer fluid function is switched on (→ page 97)

The indicator lamp on the  button will not light up in this case. After a maximum of 30

minutes, outside air will automatically be introduced again.

Switching the windshield heater on or off

- i** In the event of high outside temperatures, the windshield heater may not switch on.
- ▶ Press the  button.
If the indicator lamp on the button lights up, the windshield heater has switched on.
- i** The windshield heater switches off automatically after a few minutes.
- i** If the battery voltage is too low, it may not be possible to switch the windshield heater on. If the battery voltage becomes too low while the windshield heater is in operation, the windshield heater will switch off automatically.

Switching the rear window heater on or off

- ▶ Press the  button.
If the indicator lamp lights up, the rear window heater is switched on.

Operating air vents

Adjusting the front-compartment air vents

⚠ WARNING Risk of burns or frostbite due to being too close to the air vents

Very hot or very cold air can flow from the air vents.

- ▶ Make sure that all vehicle occupants always maintain a sufficient distance from the air vents.
- ▶ If necessary, direct the airflow to another area of the vehicle interior.

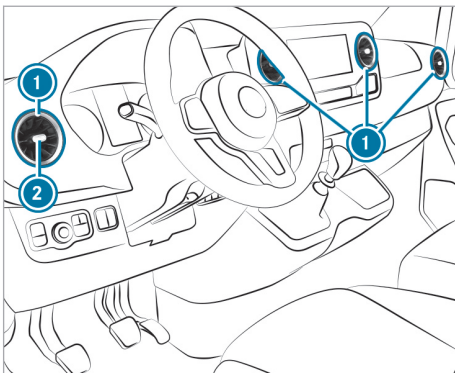

- ▶ **To open or close:** hold center **2** of air vent **1** and turn it to the left or right as far as it will go.
- ▶ **To set the airflow direction:** hold center **2** of air vent **1** and move it up or down or to the left or right.

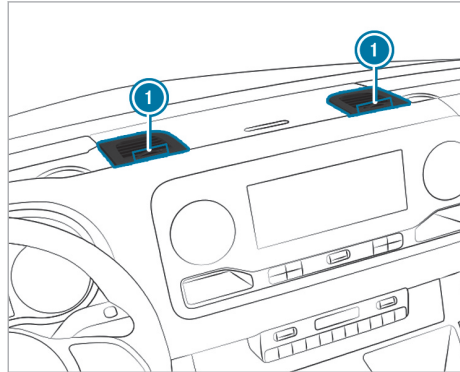

- ▶ **To open or close:** turn adjustment wheels **1** on the high-power air vents to the left or right as far as they will go.
- i** Cooled air will flow out of the high-power air vents. Heating will not be possible. Open the high-power air vents only in summer during cooling mode and keep them closed in winter.

Adjusting air vents in the roof air duct



In vehicles with a rear air conditioning system, adjustable air vents have been integrated in the roof air duct.

- ▶ **To adjust the airflow:** open or close the air flaps in air vents **1** as required.
- ▶ **To adjust the air distribution:** turn air vents **1** to the required position.

Information about air vents in the rear passenger compartment

⚠ WARNING Risk of burns or frostbite due to being too close to the air vents

Very hot or very cold air can flow from the air vents.

- ▶ Make sure that all vehicle occupants always maintain a sufficient distance from the air vents.
- ▶ If necessary, direct the airflow to another area of the vehicle interior.

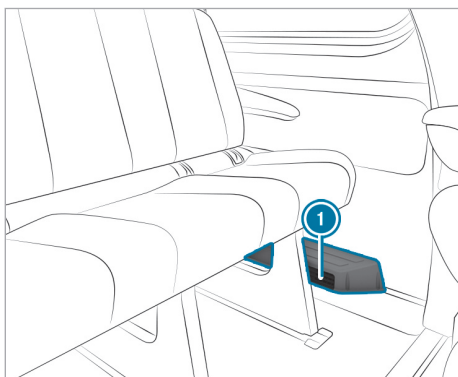

Depending on the vehicle equipment, there will be an air duct or a heater with additional air vents in the rear footwell on the left-hand side ①. Do not place any objects here. Vehicle occupants must maintain a sufficient distance due to the warm air flow and air intake.

Auxiliary heating

Notes on auxiliary heating

⚠ DANGER Risk of fatal injury due to poisonous exhaust gases

If the tailpipe is blocked or sufficient ventilation is not possible, poisonous exhaust gases such as carbon monoxide may enter the vehicle. This is the case in enclosed spaces or if the vehicle gets stuck in snow, for example.

- ▶ Always switch the stationary heater off in enclosed spaces without an air extraction system, e.g. in garages.

- ▶ Keep the tailpipe and the area around the vehicle free from snow when the engine or the stationary heater is running.
- ▶ Open a window on the side of the vehicle facing away from the wind to ensure an adequate supply of fresh air.

⚠ WARNING Risk of fire due to hot stationary heater components and exhaust gases

Flammable materials such as leaves, grass or twigs may ignite.

- ▶ When the stationary heater is switched on, make sure that:
 - Hot vehicle parts do not come into contact with flammable materials.
 - The exhaust gas can flow out of the stationary heater exhaust pipe unhindered.
 - The exhaust gas does not come into contact with flammable materials.

! NOTE Damage to the auxiliary heating

If the auxiliary heating is not used for a long time, it may be damaged.

- ▶ Switch on the auxiliary heating at least once a month for about ten minutes.

! NOTE Damage to the auxiliary heating due to overheating

If the flow of hot air is blocked, the auxiliary heating may overheat and switch off.

- ▶ Do not block the flow of hot air.

- ① **Vehicles with a modified fuel display:** if an externally operated consumer is connected via the cable for the auxiliary heating, this will not be taken into consideration on the "remaining range" display of the on-board computer. In this case, pay attention to the fuel display. The fuel display reflects the actual fill level.

If you are transporting hazardous materials, comply with the relevant safety regulations. Place objects a sufficient distance from the auxiliary heating outlet opening.

Auxiliary heating heats the air inside the vehicle to the set temperature.

Operating cargo compartment ventilation

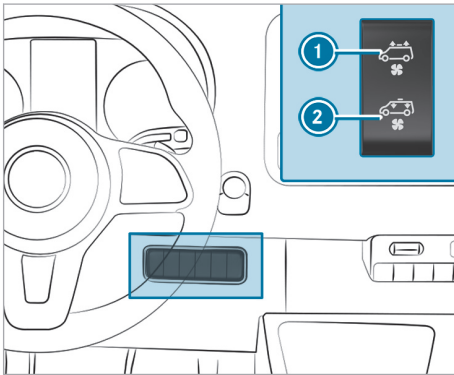

If your vehicle is equipped with a roof ventilator, you can admit fresh air to the cargo compartment, and extract air from it as well.

- ▶ Switch on the vehicle.
- ▶ **To switch on and extract:** press the top section of switch ①.
The roof ventilator will remove used air from the cargo compartment.
- ▶ **To switch on and admit fresh air:** press the bottom section of switch ②.
The roof ventilator will feed fresh air into the cargo compartment.
- ▶ **To switch off:** place the switch in the center position.

Driving

Switching on the power supply or vehicle with the start/stop button

⚠ WARNING Risk of accident and injury due to children left unattended in the vehicle

If you leave children unattended in the vehicle, they could, in particular:

- open doors, thereby endangering other persons or road users.
- get out and be struck by oncoming traffic.
- operate vehicle equipment and become trapped, for example.

In addition, the children could also set the vehicle in motion by, for example:

- releasing the parking brake.
- changing the gearbox position.
- starting the vehicle.

- ▶ Never leave children unattended in the vehicle.
- ▶ When leaving the vehicle, always take the key with you and lock the vehicle.
- ▶ Keep the key out of reach of children.

⚠ DANGER Risk of death caused by exhaust gases

Combustion engines emit poisonous exhaust gases such as carbon monoxide. Inhaling these exhaust gases is hazardous to health and leads to poisoning.

- ▶ Never leave the engine or, if present, the auxiliary heating running in an enclosed space without sufficient ventilation.

⚠ WARNING Risk of fire due to flammable materials in the engine compartment or on the exhaust system

Flammable materials may ignite.

- ▶ Therefore, regularly check that there are no flammable foreign materials in the engine compartment or on the exhaust system.

Requirements

- The key is in the detection range of the antenna (→ page 49) and the key battery is not flat.
- In addition, the following applies to vehicles with a reduced detection range: the key is located in the key holder provided in the driver's cup holder (→ page 82).

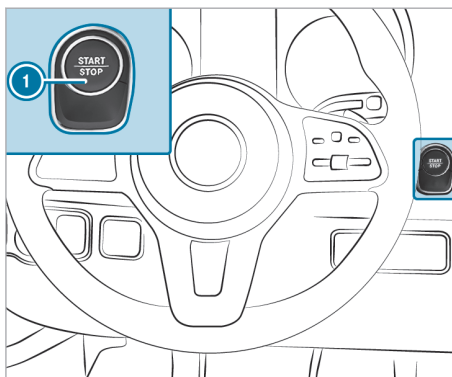

- ▶ **To switch on the power supply:** press button ① once. You can, for example, activate the windshield wiper.

The power supply will be switched off again when one of the following conditions is met:

- The driver's door is open.
- You press button ① twice.

- ▶ **To switch on the vehicle:** press button ① twice.

The indicator lamps on the instrument cluster will light up.

The vehicle will be switched off again if any of the following conditions is met:

- You do not start the vehicle within 15 minutes.
- You press button ① once.

Starting the engine

Starting the vehicle with the start/stop button

⚠ WARNING Risk of accident and injury due to children left unattended in the vehicle

If you leave children unattended in the vehicle, they could, in particular:

- open doors, thereby endangering other persons or road users.
- get out and be struck by oncoming traffic.
- operate vehicle equipment and become trapped, for example.

In addition, the children could also set the vehicle in motion by, for example:

- releasing the parking brake.
- changing the gearbox position.
- starting the vehicle.

▶ Never leave children unattended in the vehicle.

▶ When leaving the vehicle, always take the key with you and lock the vehicle.

▶ Keep the key out of reach of children.

⚠ WARNING Risk of accident and injury due to animals left unsecured or unattended in the vehicle

If you leave animals in the vehicle unattended or unsecured, they could possibly press buttons or switches.

An animal may:

- Activate vehicle equipment and become trapped, for example
- Switch systems on or off and endanger other road users

Unsecured animals may be thrown around in the vehicle in the event of an accident or sudden steering and braking maneuvers and injure vehicle occupants in the process.

▶ Never leave animals in the vehicle unattended.

▶ Always correctly secure animals while driving, e.g. using a suitable animal carrier.

Requirements:

- The key is in the detection range of the antenna (→ page 49) and the key battery is not flat.
- In addition, the following applies for vehicles with a reduced detection range: the key is located in the key holder provided in the driver's cup holder (→ page 82).

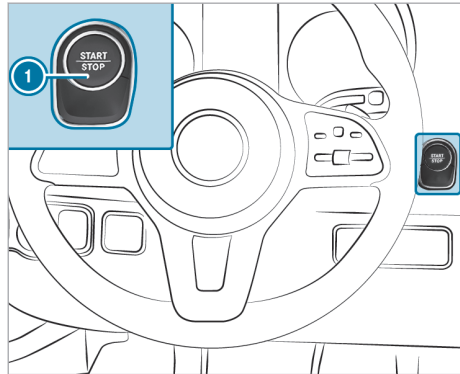

▶ **Vehicles with automatic transmission:** shift the transmission to position **P** or **N**.

▶ Depress the brake pedal and press button **1** once.

▶ If the vehicle does not start: switch off any unnecessary consumers and press button **1** once.

▶ If the vehicle still does not start and the display message **Place Key in Marked Space** See **Operator's Manual** appears in the instrument cluster: start the vehicle in emergency operation mode (→ page 112).

Starting the vehicle via Remote Online Services

■ Cooling or heating the vehicle interior before commencing your journey

ⓘ Remote engine start may not be available in all Sprinter models. The feature's availability for Sprinter depends on the services offered via "Mercedes me".

Ensure the following before starting the engine:

- The legal stipulations in the area where your vehicle is parked allow engine starting by smartphone.
- It is safe to start and run the engine where your vehicle is parked.

- The fuel tank is sufficiently filled.
- The starter battery is sufficiently charged.

■ Starting the vehicle (Remote Online)

⚠ WARNING Risk of crushing or entrapment due to unintentional starting of the engine

Limbs could be crushed or trapped if the engine is started unintentionally during service or maintenance work.

- ▶ Always secure the engine against unintentional starting before carrying out maintenance or repair work.

Requirements:

- Park position **P** is engaged.
- The anti-theft alarm system is not activated.
- The panic alarm is not activated.
- The hazard warning lights are switched off.
- The hood is closed.
- The doors are closed and locked.

- ▶ Start the vehicle using the smartphone. After every vehicle start, the engine runs for ten minutes.

You can carry out a maximum of two consecutive starting attempts. The vehicle must be started once with the key before you try to start the vehicle again with the smartphone. You can stop the vehicle again at any time.

- ⓘ Further information can be found in the smartphone app.

Preventing the engine from starting before carrying out maintenance or repair work:

- ▶ Switch on the hazard warning lamps.
or
- ▶ Unlock the doors.
or
- ▶ Open a side window or the soft top.

■ Starting the vehicle in emergency operation mode

⚠ WARNING Risk of accident and injury due to children left unattended in the vehicle

If you leave children unattended in the vehicle, they could, in particular:

- open doors, thereby endangering other persons or road users.
- get out and be struck by oncoming traffic.
- operate vehicle equipment and become trapped, for example.

In addition, the children could also set the vehicle in motion by, for example:

- releasing the parking brake.
- changing the gearbox position.
- starting the vehicle.

- ▶ Never leave children unattended in the vehicle.
- ▶ When leaving the vehicle, always take the key with you and lock the vehicle.
- ▶ Keep the key out of reach of children.

If the vehicle does not start and the display message **Place Key in Marked Space See Operator's Manual** appears on the instrument cluster, you can start the vehicle in emergency operation mode.

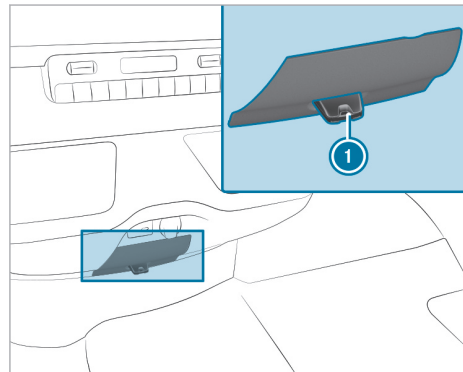

- ▶ Remove key ① from your key ring.
- ▶ Insert key ① into the slot. The vehicle will start after a short time.

- ▶ Leave the key inserted during the entire journey.
If you pull key ① out of the slot, the engine will continue to run.
- ▶ Have key ① checked at a qualified specialist workshop.

If the vehicle does not start:

- ▶ Leave key ① in the slot.
 - ▶ Depress the brake pedal.
 - ▶ Start the vehicle with the start/stop button.
- ① You can also switch on the power supply or the vehicle with the start/stop button.

Breaking-in notes

Protect the engine during the first 1,000 miles (1,500 km) by:

- driving at varying road and engine speeds.
- shifting to the next higher gear at the very latest when the needle reaches the last third before the red area in the tachometer.
- avoiding stress on the vehicle such as driving at full throttle.
- not shifting down to a lower gear to brake the vehicle.
- gradually increasing the engine speed and accelerating the vehicle up to full speed only after 1,000 miles (1,500 km).
- **vehicles with automatic transmission:** not depressing the accelerator pedal beyond the pressure point (kickdown).

This also applies if the engine or parts of the drivetrain have been replaced.

Also observe the following breaking-in notes:

- After the vehicle has been delivered or after repairs, the sensor system of the ESP® driving safety system adjusts itself automatically while the vehicle is driven a certain distance. Full system effectiveness is not reached until the end of this teach-in process.
- New or replaced brake pads, brake discs and tires only provide optimal braking and grip after several hundred kilometers. Until then, compensate for the reduced braking effect by depressing the brake pedal with greater force.

Driving tips

Notes on driving

⚠ DANGER Risk of death caused by exhaust gases

Combustion engines emit poisonous exhaust gases such as carbon monoxide. Inhaling these exhaust gases is hazardous to health and leads to poisoning.

- ▶ Never leave the engine or, if present, the auxiliary heating running in an enclosed space without sufficient ventilation.

⚠ WARNING Risk of skidding and of an accident due to shifting down on slippery road surfaces

If you shift down on slippery road surfaces to increase the engine braking effect, the drive wheels may lose traction.

- ▶ Do not shift down on slippery road surfaces to increase the engine braking effect.

⚠ DANGER Risk of fatal injury due to poisonous exhaust gases

If the tailpipe is blocked or sufficient ventilation is not possible, poisonous exhaust gases such as carbon monoxide may enter the vehicle. This is the case, for example, if the vehicle gets stuck in the snow.

- ▶ Keep the tailpipe and the area around the vehicle free from snow when the engine or the stationary heater is running.
- ▶ Open a window on the side of the vehicle facing away from the wind to ensure an adequate supply of fresh air.

⚠ WARNING Risk of accident due to objects in the driver's footwell

Objects in the driver's footwell may impede pedal travel or block a depressed pedal.

This will jeopardize the operating and road safety of the vehicle.

- ▶ Stow all objects in the vehicle securely so that they cannot get into the driver's footwell.
- ▶ Make sure that there is always sufficient clearance for the pedals.

- ▶ Ensure there are non-slip attachments for floor mats and carpets.
- ▶ Do not lay multiple floor mats or carpets on top of one another.

⚠ WARNING Risk of accident due to incorrect footwear

Incorrect footwear includes, for example:

- Shoes with platform soles
- Shoes with high heels
- Slippers

There is a risk of an accident.

- ▶ Always wear suitable footwear so that you can operate the pedals safely.

⚠ WARNING Risk of accident if the vehicle is switched off while driving

If you switch off the vehicle while driving, safety functions are restricted or no longer available.

This may affect the power steering system and the brake force boosting, for example.

You will need to use considerably more force to steer and brake, for example.

- ▶ Do not switch off the vehicle while driving.

⚠ WARNING Risk of accident and injury due to being under the influence of alcohol and drugs while driving

Drinking and driving and/or taking drugs and driving are very dangerous combinations. Even a small amount of alcohol or drugs can affect your reflexes, perceptions and judgment.

The possibility of a serious or even fatal accident are greatly increased when you drink or take drugs and drive.

- ▶ Do not drink or take drugs and drive or allow anyone to drive who has been drinking or taking drugs.

⚠ WARNING Risk of accident and injury from operating mobile communications equipment

If you operate mobile communication equipment when driving, you will be distracted from the traffic situation. This could also cause you to lose control of the vehicle.

The probability of a serious or even fatal accident increases greatly if you operate mobile communication equipment when driving.

- ▶ Only operate mobile communication equipment when the vehicle is stationary.

For your own safety, observe the following points when operating mobile communications equipment:

- Please observe the legal requirements for the country in which you are driving.
- While driving, only operate mobile communications equipment when the traffic conditions permit it. You could otherwise be distracted from traffic, cause an accident and injure yourself and others.

⚠ WARNING Risk of accident due to overheated brake system

If you rest your foot on the brake pedal during while driving, the brake system may overheat.

This increases the braking distance and the brake system may even fail.

- ▶ Never use the brake pedal as a footrest.
- ▶ Do not press the brake pedal and accelerator pedal simultaneously while driving.

On long and steep downhill gradients, you must shift down to a lower gear in good time. This is particularly important when driving a loaded vehicle. You are thus making full use of the engine's braking effect. This will take some of the strain off the brake system and prevent the brakes from overheating and wearing too quickly.

! **NOTE** Wearing out the brake linings by continuously depressing the brake pedal

- ▶ Do not depress the brake pedal continuously whilst driving.
- ▶ To use the braking effect of the engine, shift to a lower gear in good time.

! **NOTE** Damage to the drivetrain and engine when pulling away

- ▶ Do not warm up the engine while the vehicle is stationary. Pull away immediately.
- ▶ Avoid high engine speeds and driving at full throttle until the engine has reached its operating temperature.

! **NOTE** Damage to the catalytic converter due to non-combusted fuel

The engine is not running smoothly and is mis-firing.

Non-combusted fuel may get into the catalytic converter.

- ▶ Only depress the accelerator pedal slightly.
- ▶ Have the cause rectified immediately at a qualified specialist workshop.

! **NOTE** Vehicle damage due to failure to observe the maximum permissible clearance height

If the vehicle height exceeds the maximum permissible clearance height, the roof and other vehicle parts may be damaged.

- ▶ Please observe the maximum clearance height indicated.
- ▶ If the vehicle exceeds the permissible clearance height, do not drive in.
- ▶ Take the modified vehicle height into account in the case of roof superstructures or other carrier systems.

- i** Please bear in mind that all the speeds indicated in this Operator's Manual are approximate and are subject to a certain tolerance.

Exhaust emission monitoring

Specific engine systems are designed to keep poisonous components of exhaust gases within legal limits.

These systems only work optimally if they are maintained exactly according to manufacturer's specifications. It is for this reason that all work on the engine should only be performed by qualified and authorized Mercedes-Benz Center technicians.

Under no circumstances should engine settings be changed. In addition, all specific maintenance work must be performed at regular intervals and in compliance with the service regulations of the dealer specified in the publication details. Refer to the maintenance booklet for details.

Notes on short-distance trips

If the vehicle is predominantly used for short-distance driving, fuel may accumulate in the engine oil and cause engine damage.

If you mainly drive short distances, you should drive on a freeway or country road for 20 minutes

every 480 km (300 miles). This will facilitate the regeneration of the diesel particulate filter.

Notes on speed limitation

! **WARNING** Risk of injury through exceeding the specified tire load-bearing capacity or the permissible speed rating

Exceeding the specified tire load rating or the permissible speed rating may lead to tire damage and to the tires bursting.

- ▶ Therefore, only use tire types and sizes approved for your vehicle model.
- ▶ Observe the tire load rating and speed rating required for your vehicle.

Find out about the maximum permissible speed resulting from the tires, i.e. tires and tire pressure. Please observe the legal requirements for tires for the country you are in.

- i** **Vehicles with tachograph:** due to the different certification requirements for the tachograph and instrument cluster, the displayed speeds may differ. Please keep to the speed display on the instrument cluster.

You can permanently limit the speed of your vehicle.

Mercedes-Benz recommends a qualified specialist workshop for programming the speed limitation.

Note that you cannot exceed a programmed speed limitation when overtaking.

On downhill gradients, the speed limitation may be exceeded. Apply the brakes if necessary.

Display messages will warn you that you are approaching the speed limitation.

- i** For bus-equipped vehicles, the ex-works speed limitation for your vehicle is 60 mph (100 km/h) When overtaking, bear in mind that the speed limitation cannot be exceeded.

Information about driving abroad

Service

An extensive Mercedes-Benz service is also available abroad. Nevertheless, please remember that services or spare parts may not be available immediately. The relevant workshop directories are available from an authorized Mercedes-Benz Center.

Fuel

In some countries, only fuels with an increased sulfur content are available.

Mercedes-Benz recommends installing a fuel filter with a water separator for countries in which diesel has an increased water content.

Unsuitable fuel can cause engine damage. Information about fuel can be found in the "Fuel" section (→ page 272).

Information about transport by rail

Transporting your vehicle by rail may be subject to certain restrictions or require special measures to be taken in some countries due to varying tunnel heights and loading standards.

You can obtain information about this from any authorized Mercedes-Benz Center.

Information on braking

⚠ WARNING Risk of skidding and of an accident due to shifting down on slippery road surfaces

If you shift down on slippery road surfaces to increase the engine braking effect, the drive wheels may lose traction.

- ▶ Do not shift down on slippery road surfaces to increase the engine braking effect.

⚠ WARNING Risk of accident due to the brake system overheating

If you leave your foot on the brake pedal when driving, the brake system may overheat.

This increases the braking distance and the brake system can even fail.

- ▶ Never use the brake pedal as a footrest.
- ▶ Do not depress the brake pedal and the accelerator pedal at the same time while driving.

! NOTE Wearing out the brake linings by continuously depressing the brake pedal

- ▶ Do not depress the brake pedal continuously whilst driving.
- ▶ To use the braking effect of the engine, shift to a lower gear in good time.

Downhill gradients

On long and steep downhill gradients you should observe the following instructions:

- in vehicles with an automatic transmission, shift down to shift ranges **2** or **1** in good time

so that the engine is running at a medium to high engine speed (→ page 126).

- ⓘ Change the shift range in good time when cruise control is activated. Observe the driving tips (→ page 113).

You thereby make use of the braking effect of the engine and do not have to brake as often to maintain the speed. This relieves the load on the service brake and prevents the brakes from overheating and wearing too quickly.

Heavy and light loads

If the brakes have been subjected to heavy use, do not park the vehicle immediately. Drive on for a short while. The brakes cool down more quickly in the airflow.

If you only make moderate use of the brakes, you should occasionally test their effectiveness. To do this, brake more firmly from a higher speed while paying attention to the traffic conditions. The brakes will grip better as a result.

Wet road surfaces

If you have been driving for a long time in heavy rain without braking, there may be a delayed response when you first apply the brakes. This may also occur after driving through a car wash or deep water. You must depress the brake pedal more firmly. Maintain a greater distance from the vehicle in front.

While paying attention to the traffic conditions, you should brake the vehicle firmly after driving on a wet road surface or through a car wash. This heats the brake discs so that they dry more quickly, which protects them against corrosion.

Impaired braking effect on roads treated with deicing salt:

- a layer of salt on the brake discs or brake linings can increase braking distances considerably, or braking may only be one-sided
- maintain an especially large safety distance from the vehicle in front

To remove the layer of salt:

- apply the brakes from time to time, paying attention to traffic conditions
- depress the brake pedal gently at the end of a journey and when starting a new journey

Checking the brake lining thickness

In addition to monitoring by the brake lining wear sensor, you can regularly monitor and check all of

the brake linings by a visual inspection for material wear.

If you are unable to check the brake lining wear on the inside of the wheels, remove the wheels if you possess the required skills. Otherwise visit a qualified specialist workshop.

If the brake lining material thickness is less than 0.12 in (3 mm), have the brake linings checked and if necessary replaced at a qualified specialist workshop.

Do not rely solely on the brake lining wear sensor.

It is also strongly recommended that you have the brake linings checked at a qualified specialist workshop, and not only during every service prompted by the service interval display. Also check the brake linings before long journeys, and whenever the wheels are removed.

Check the brake linings in the following situations:

- during every service according to the service interval
- before long journeys
- every time a tire is replaced
- make regular visual inspections for your own safety

New brake discs and brake linings

New brake linings and brake discs only reach their optimal braking effect after a few hundred miles (a few hundred kilometres).

Until then, compensate for the reduced braking effect by pressing the brake pedal with greater force. For safety reasons, Mercedes-Benz recommends that you only have brake linings and brake discs which are approved by Mercedes-Benz installed in your vehicle.

Other brake discs or brake linings may compromise the safety of your vehicle.

Always replace all brake discs and brake linings on an axle at the same time. Always fit new brake linings when replacing brake discs.

Vehicles with a manual parking brake

⚠ WARNING Risk of skidding or an accident by braking with the parking brake

If you have to brake your vehicle with the parking brake, the braking distance is considerably longer and the wheels may lock. There is an increased risk of skidding and/or accident.

- ▶ Only brake the vehicle with the parking brake if the service brake has failed.
- ▶ In this case, do not apply the parking brake with too much force.
- ▶ If the wheels lock, immediately release the parking brake as much as required for the wheels to turn again.

When driving on wet roads or dirt-covered surfaces, deicing salt or dirt may get into the parking brake. This causes corrosion and a reduction of braking force.

In order to prevent this, drive with the parking brake lightly applied from time to time.

When doing so, drive for a distance of approximately 300 ft at a maximum speed of 13 mph (20 km/h).

The brake lights do not light up when you brake the vehicle with the parking brake.

Information about driving on wet roads

Hydroplaning

⚠ WARNING Risk of hydroplaning due to insufficient tire tread

Depending on the level of water on the road surface, hydroplaning may occur.

- ▶ Avoid tire ruts and brake carefully.
- ▶ Change tires that do not have sufficient tire tread.

Therefore, in heavy rain or other conditions in which hydroplaning can occur, drive as follows:

- reduce your speed.
- avoid tire ruts.
- brake carefully.

Driving on flooded roads

Bear in mind that vehicles traveling in front or in the opposite direction create waves. This may cause the maximum permissible water depth to be exceeded. These notes must be observed under all circumstances. Otherwise, you could damage the engine, electrics and transmission.

If you have to drive on stretches of road on which water has collected, please bear in mind the following:

- the level of standing water must not be above the lower edge of the front bumper
- you must drive no faster than walking pace.

Observe the notes on fording while off road for all-wheel-drive vehicles (→ page 118).

Information about driving in winter

⚠ DANGER Risk of fatal injury due to poisonous exhaust gases

If the tailpipe is blocked or sufficient ventilation is not possible, poisonous exhaust gases such as carbon monoxide may enter the vehicle.

This is the case, for example, if the vehicle gets stuck in the snow.

- ▶ Keep the tailpipe and the area around the vehicle free from snow when the engine or the stationary heater is running.
- ▶ Open a window on the side of the vehicle facing away from the wind to ensure an adequate supply of fresh air.

⚠ WARNING Risk of skidding and of an accident due to shifting down on slippery road surfaces

If you shift down on slippery road surfaces to increase the engine braking effect, the drive wheels may lose traction.

- ▶ Do not shift down on slippery road surfaces to increase the engine braking effect.

Vehicles with automatic transmission may roll in neutral position **N** for only a short time. Allowing the wheels to roll for a longer period, e.g. when towing, will lead to transmission damage.

If the vehicle is at risk of skidding, or cannot be stopped when traveling at a low speed, you can stabilize the vehicle using the following measures:

- Shift the automatic transmission to neutral position **N**.
- Try to maintain control of the vehicle using corrective steering.

Drive particularly carefully on slippery roads. Avoid sudden acceleration, steering and braking maneuvers.

Have your vehicle winterproofed at a qualified specialist workshop in good time at the onset of winter.

Please observe the notes on snow chains (→ page 239).

Regularly check the vehicle and remove snow or ice when traveling in wintry conditions.

An accumulation of snow and ice, particularly when frozen, in the area around the air intake, moving parts, the axles and the wheel wells may cause the following problems:

- obstruction of the air intake
- damage to vehicle parts
- Malfunctions due to restriction of the movement intended by the design (e.g. reduced steering movement)

If there is any damage, inform a qualified specialist workshop.

Information about driving off-road

⚠ WARNING Risk of accident if you do not keep to line of fall on inclines

If you drive at an angle or turn on an incline, the vehicle could slip sideways, tip and rollover.

- ▶ Always drive on inclines in the line of fall (straight up or down) and do not turn.

⚠ WARNING Risk of injury from acceleration forces during off-road driving

You could be thrown from your seat, for example.

- ▶ Always wear your seat belt even when driving off-road.

⚠ WARNING Risk of injury to the hands when driving over obstacles

If you drive over obstacles or in tire ruts, the steering wheel may whip around.

- ▶ The steering wheel must always be held securely with both hands.
- ▶ Always hold the steering wheel so that your thumbs are on the outer rim of the steering wheel.
- ▶ When driving over obstacles, expect increased steering forces at short notice.

⚠ WARNING Risk of fire caused by flammable material on hot exhaust system components

Flammable material such as leaves, grass or twigs may ignite if they come into contact with hot parts of the exhaust system.

- ▶ When driving on an unpaved road or off-road, check the vehicle underside regularly.
- ▶ In particular, remove trapped plant parts or other flammable material.
- ▶ If there is damage, consult a qualified specialist workshop immediately.

! **NOTE** Damage to the vehicle after driving off-road

Foreign bodies, such as stones and branches, could become trapped on the vehicle underside or on wheels and tires while you are driving and cause damage to the vehicle.

Foreign bodies could cause the following damage:

- Damage the suspension, the fuel tank or the brake system
- Cause imbalances and thus vibrations
- ▶ Regularly remove any trapped foreign bodies, e.g. stones and branches.
- ▶ After driving off-road, check carefully whether there is any damage to the vehicle.
- ▶ If there is damage, have the vehicle checked at a qualified specialist workshop.

When driving off-road or on unpaved surfaces, check the vehicle underside, wheels and tires at regular intervals. In particular, remove any trapped foreign bodies, e.g. stones and branches.

Please observe the following notes regarding foreign bodies of this kind:

- They could damage the suspension, the fuel tank or the brake system.
- They could cause imbalances and thus vibrations.
- They could be ejected from the vehicle when you continue driving.

If there is any damage, inform a qualified specialist workshop.

When driving off-road on steep inclines, first make sure that the DEF[®] tank is sufficiently filled. Therefore, ensure a level of at least 2.6 gal (10 l) before off-road driving.

When driving off-road and on construction sites, sand, mud and water, for example, also mixed with

oil, can get into the brakes. This could lead to a reduction in braking effect or total brake failure, including as a result of increased wear. The braking characteristics vary depending on the material that has infiltrated the system. Clean the brakes after driving off-road. If you then notice a reduced braking effect or hear scraping noises, have the brake system checked immediately at a qualified specialist workshop. Adjust your driving style to the changed braking characteristics.

Driving off-road or on construction sites increases the possibility of vehicle damage, which could in turn lead to the failure of certain major assemblies or systems. Adapt your driving style to the off-road driving conditions. Drive carefully. Have any vehicle damage repaired at a qualified specialist workshop as soon as possible.

When driving in rough terrain, do not shift the transmission to neutral and do not disengage the clutch. You could lose control when attempting to brake the vehicle with the service brake. If your vehicle cannot manage an uphill incline, drive back down in reverse gear.

When loading your vehicle for driving off-road or on a construction site, keep the vehicle's center of gravity as low as possible.

Check-list before driving off-road

- Check the fuel and DEF[®] levels (→ page 176) and top up if necessary (→ page 132).
- **Engine:** check the oil level and add oil if necessary (→ page 217). Before driving up or down extreme slopes, fill the oil to the maximum level.
- ⓘ If you drive up or down extreme inclines or slopes, the  symbol may appear on the instrument cluster display. The engine operating safety is not put at risk if you have filled the engine oil to the maximum level beforehand.
- **Vehicle tool kit:** check that the jack is working (→ page 257).
- Make sure that a lug wrench (→ page 257), a wooden underlay for the jack, a sturdy tow rope, a folding spade and a wheel chock (present, depending on equipment) are carried in the vehicle.
- **Tires and wheels:** check the tire tread depth (→ page 238) and the tire pressure (→ page 246).

Rules for off-road driving

Always be aware of the vehicle's ground clearance and avoid obstacles such as deep tire ruts.

Obstacles can damage the following parts of the vehicle, for example:

- suspension
- drivetrain
- fuel and service products reservoirs

Therefore, always drive slowly in terrain. If you must drive over obstacles, have the front passenger guide you.

- ① Mercedes-Benz recommends that you additionally carry a shovel and a recovery rope with a shackle in the vehicle.
- Make sure that loads and items of luggage are securely stowed or lashed down (→ page 209).
- Before driving off-road, stop the vehicle and engage a low gear.
- **Vehicles with DSR:** activate DSR when you are driving downhill (→ page 151).
- If the surface requires, temporarily deactivate ESP® when starting off (→ page 146).
- Drive off-road only with the engine running and a gear engaged.
- Drive slowly and smoothly. It may often be necessary to drive at walking pace.
- Avoid spinning wheels.
- Ensure that the wheels remain in contact with the ground.
- As a precaution, get out of the vehicle to take a look at the route ahead. Exercise the utmost caution when driving across unfamiliar, unpredictable terrain.
- Look out for obstacles (e.g. rocks, holes, tree stumps and tire ruts).
- Avoid edges where the ground could crumble or break away.

Notes on driving when there is water on the road

Water ingress can damage the engine, electrics and transmission.

Water can also enter the air intake of the engine and cause engine damage.

Observe the following if you must drive through water:

- The water, when calm, must reach only the lower edge of the front bumper.
- Drive at walking pace at most; water could otherwise enter the vehicle interior or engine compartment.
- Vehicles traveling in front or oncoming vehicles can create waves that may exceed the maximum permissible height of the water.

The braking effect of the brakes is reduced after fording. Brake carefully while paying attention to the traffic conditions until braking power has been fully restored.

After the vehicle has forded at maximum depth several times, all oils in the major assemblies (locking differential, manual transmission/automatic transmission and transfer case) must be replaced.

Rules for off-road fording

- Observe the safety notes and general notes on driving off-road.
- Check the depth and characteristics of the body of water before fording. The water, when calm, must reach only the lower edge of the front bumper.
- The climate control system is off (→ page 104).
- The auxiliary heater is off.
- Restrict the shift range to **1** or **2**.
- Avoid high engine speeds.
- Drive slowly and smoothly at no more than a walking pace.
- Ensure that no wave forms at the front of the vehicle while driving.
- After fording, dry the brakes.
- After the vehicle has forded at maximum depth several times, all oils in the major assemblies (locking differential, manual transmission/automatic transmission and transfer case) must be replaced.

Check-list after driving off-road

Driving in terrain places greater demands on your vehicle than normal road operation. Check your vehicle after driving in rough terrain. This allows you to detect damage promptly and reduce the risk of an accident for yourself and other road users. Clean your vehicle thoroughly before driving on public roads.

If you find damage to the vehicle after off-road driving, have the vehicle checked at a qualified specialist workshop immediately.

Please note the following points after driving off-road, on construction sites and before driving on public roads:

- **Vehicles with DSR:** deactivate DSR (→ page 151).
- Activate ESP® (→ page 146).
- Clean the exterior lighting, particularly the headlamps and tail lamps, and check them for damage.
- Clean the front and rear license plate.
- Clean the windshield, windows and outside mirrors.
- Clean the steps, entrances and grab handles. This will make your footing safer.
- Clean the wheels and tires, wheel wells and the underbody of the vehicle with a jet of water. This increases traction, especially on wet road surfaces.
- Check the wheels and tires and wheel wells for trapped foreign objects and remove them. Trapped foreign objects can damage the wheels and tires or could be ejected from the vehicle as the vehicle is driving along.
- Check the underbody for trapped branches or other parts of plants and remove them.
- Clean the brake disks, brake pads and axial joints, particularly after operation in sand, mud, grit and gravel, water or similar conditions.
- Check the entire floor assembly, the tires, wheels, body structure, brakes, steering, suspension and exhaust system for any damage.
- Check the service brake for operating safety, e.g. carry out a brake test.
- If you notice strong vibrations after driving off-road, check the wheels and drivetrain for foreign objects again. Remove any foreign objects that can lead to imbalances and thus cause vibrations. In the event of damage to the wheels and the drivetrain, visit a qualified specialist workshop immediately.

Information about driving in mountainous areas

Vehicles with diesel engines: the operating safety of the diesel engine is guaranteed up to an elevation of 2500 m above sea level. You may exceed this elevation for a short time, such as in mountainous terrain. Do not drive for long periods at

elevations above 2500 m. Otherwise, you may damage the diesel engine.

When driving in the mountains, note that engine output – and thus start-off gradeability – will decrease as elevation increases. The ECO start/stop function will no longer be available when you are driving at elevations higher than 2500 m above sea level. Notes on braking on downhill gradients can be found in Notes on braking(→ page 116).

Deactivating or activating the reverse warning device

⚠ WARNING Risk of accidents due to persons or objects in the area in which you are maneuvering

Other road users may not hear or may ignore the warning tone of the backing up warning device. There is a risk of an accident.

- ▶ Make sure that there are no persons or objects in the maneuvering area during maneuvering.
- ▶ If necessary, a second person must assist with maneuvering.

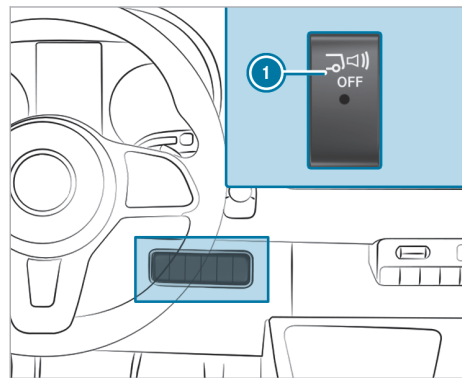

The reverse warning device is a system designed to assist you in ensuring the safety of other road users. The reverse warning device cannot guarantee that no persons or objects are situated behind the vehicle.

The reverse warning device is an acoustic warning system integrated into the tail lamp of the vehicle. When you shift to reverse gear, the reverse warning device is activated.

Observe the legal requirements for the country in which you are currently driving when using the reverse warning device.

For vehicles in the United Kingdom and Switzerland: the reverse warning device can be deactivated.

▶ **To deactivate/activate:** press the upper section of switch ①.

If the reverse warning device is deactivated, the indicator light in the switch lights up.

Function of the ECO display

The ECO display summarizes your driving characteristics from the start of a journey to its completion and assists you in achieving the most economical driving style.

For vehicles with automatic transmission

You can influence consumption by doing the following:

- Anticipating road and traffic conditions.

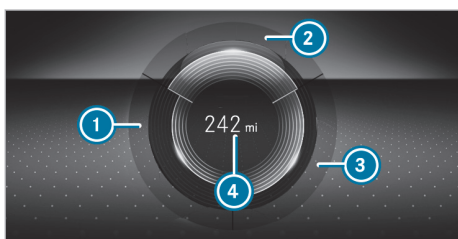

Instrument cluster display (color)

The segment's lettering will light up brightly, the outer edge will light up and the segment will be filled when the vehicle is driven with the following characteristics:

- ① **ACCELERATION:** moderate acceleration
- ② **CONSTANT:** consistent speed
- ③ **COASTING:** gentle deceleration and rolling

The segment's lettering will be gray, the outer edge will be dark and the segment will be emptied when the vehicle is driven with the following characteristics:

- ① **ACCELERATION:** sporty acceleration
- ② **CONSTANT:** fluctuating speed
- ③ **COASTING:** heavy braking

You have driven in an economical manner if:

- The three segments are completely filled simultaneously.
- The edges of all three segments light up.

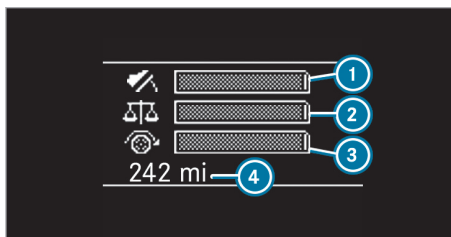

Instrument cluster display (black and white)

The bars will fill up when the vehicle is driven with the following characteristics:

- ① Moderate acceleration
- ② Consistent speed
- ③ Gentle deceleration and coasting

The bars will empty when the vehicle is driven with the following characteristics:

- ① Sporty acceleration
- ② Fluctuating speed
- ③ Heavy braking

The instrument cluster display will also show additional range ④ **Bonus mi From Start** or **mi From Start** that you have achieved with your driving style compared with a driver with a very sporty driving style. The range displayed does not indicate a fixed reduction in consumption.

Diesel particulate filter

Notes on regeneration

⚠ DANGER Risk of death caused by exhaust gases

Combustion engines emit poisonous exhaust gases such as carbon monoxide. Inhaling these exhaust gases is hazardous to health and leads to poisoning.

▶ Never leave the engine or, if present, the auxiliary heating running in an enclosed space without sufficient ventilation.

⚠ WARNING Risk of fire caused by hot exhaust system parts

Flammable materials such as leaves, grass or twigs may ignite.

- ▶ Park the vehicle so that no flammable material can come into contact with hot vehicle components.
- ▶ In particular, do not park on dry grass-land or harvested grain fields.

! **NOTE** Damage due to hot exhaust gases

Very hot exhaust gases are emitted from the tailpipe during regeneration.

- ▶ During regeneration, maintain a minimum distance of 7 ft (2 m) to other objects, e.g. parked vehicles.
- ▶ Carry out regeneration only on concrete or asphalt surfaces.
- ▶ Do not carry out regeneration in the immediate vicinity of people.
- ▶ Carry out regeneration in the open air and not in closed halls or rooms.
- ▶ Make sure that there are no flammable materials or objects in the area of the exhaust system.

Regeneration is permitted only while you are driving or at a qualified specialist workshop with an extraction system.

Regeneration without interruption takes approximately 20-25 minutes.

If the vehicle is used predominantly for short-distance driving or has extended non-operational times, this could lead to a malfunction in the automatic cleaning function of the diesel particulate filter. As a result, the diesel particulate filter may become blocked. Fuel may also accumulate in the engine oil and cause engine damage.

If you mainly drive short distances, you should drive on a highway or go for a country drive for 20 minutes every 500 km (300 miles). This will facilitate the diesel particulate filter's burn-off process.

- ⓘ Manual regeneration of the diesel particulate filter when stationary is classified as special equipment and is not installed as standard.

■ Starting and canceling regeneration

Requirements:

- All system conditions are fulfilled.
- The load condition of the diesel particulate filter is at least 100% and at most 129%.
- The vehicle is stationary.
- The parking brake is applied.

- The vehicle has been started.
- Transmission position **P** is engaged.
- If the vehicle has a transmission-mounted power take-off, the latter is deactivated.
- If the vehicle has a parameterizable special module, the rpm request is deactivated.

- ⓘ Regeneration when stationary is no longer possible from a load condition of 130%.

On-board computer:

↳ [Service](#) ▶ [Particle Filter](#)

- ▶ **To request regeneration:** select **OK**.
- ▶ **To observe the vehicle surroundings:** make sure that no injuries or damage due to the hot exhaust gases can occur in the vehicle surroundings. Confirm for three seconds with **OK**. Regeneration starts. The engine speed increases and the message **Regeneration Active** appears.

- ⓘ The duration of regeneration depends on the load condition of the diesel particulate filter (approx. 20-25 minutes). After successful regeneration, the engine speed is reduced again.

- ▶ **To cancel regeneration:** switch off the vehicle or depress the coupling (for manual transmission) or brake (for automatic transmission). Regeneration is canceled.

Regeneration cannot be requested again until the load condition of the diesel particulate filter is at least 100% and at most 129%.

■ Displaying the load

On-board computer:

↳ [Service](#) ▶ [Particle Filter](#)

The load of the diesel particulate filter is displayed.

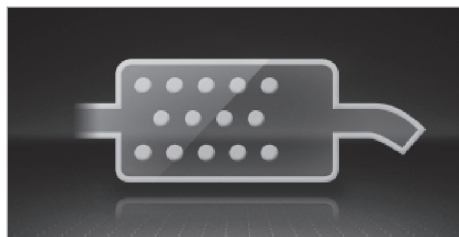

Load display at 75% load

- ▶ **To exit the display:** press the back button on the left-hand side of the steering wheel.

Bear in mind the following related topic:

- Operating the on-board computer (→ page 177)

Battery main switch

Notes on the battery main switch

! **NOTE** Damaged to control units and cooled component parts

When the main battery switch is removed immediately, cooling of important component parts and the storage of parameters in the control units can be interrupted. This can significantly reduce the service life of component parts and control units.

- ▶ Make sure that vehicle is switched off. Then wait at least 20 minutes before removing the battery main switch.

You can use the battery main switch to disconnect the current to all your vehicle's consumers. This will prevent uncontrolled battery discharge caused by quiescent current consumers.

If your vehicle is equipped with an auxiliary battery in the engine compartment or in the base of the co-driver seat, you must disconnect both batteries. Only then is the electrical system fully disconnected from the power supply.

- i** Only disconnect the vehicle from the power supply using the battery main switch in the following situations:
- The vehicle is stationary for a long time
 - It is absolutely necessary to disconnect the vehicle from the power supply

After switching on the power supply, you will need to readjust the side windows (→ page 65) and the electric sliding door (→ page 59).

Switching the power supply on/off

Switching off the power supply

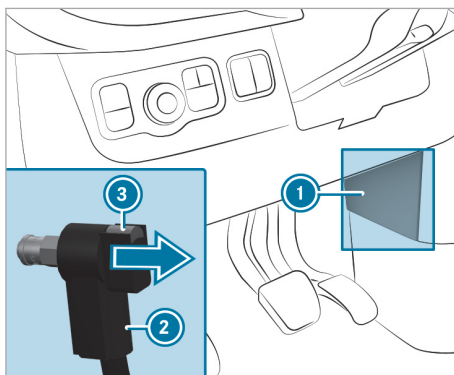

Battery main switch

- i** Note the remaining time before the next service due date (→ page 214) and oil change (→ page 275). The time recording is also disrupted if the battery supply is disconnected.
- ▶ Switch off the vehicle and wait at least 20 minutes.
 - ▶ Remove cover **1**. To do this, take hold of the cover at the upper edge, move it outwards in the direction of the driver's door and lift it off.
 - ▶ Press and hold button **3**.
 - ▶ Pull plug **2** out of the earth pin.
 - ▶ Push plug **2** as far as possible in the direction of the arrow so that it cannot make contact with the earth pin. All starter battery consumers are disconnected from the power supply.

Switching on the power supply

- ▶ Press plug **2** onto the earth pin until you feel it engage and plug **2** is in full contact with the earth pin. All starter battery consumers are reconnected to the power supply.
- ▶ Fasten cover **1**. To do this, place the cover on from above.
- ▶ Press the cover into the neighbouring switching console on the right hand side.

Automatic transmission

DIRECT SELECT lever

Function of the DIRECT SELECT lever

⚠ WARNING Risk of accident and injury due to children left unattended in the vehicle

If you leave children unattended in the vehicle, they could, in particular:

- open doors, thereby endangering other persons or road users.
- get out and be struck by oncoming traffic.
- operate vehicle equipment and become trapped, for example.

In addition, the children could also set the vehicle in motion by, for example:

- releasing the parking brake.
 - changing the gearbox position.
 - starting the vehicle.
- ▶ Never leave children unattended in the vehicle.
- ▶ When leaving the vehicle, always take the key with you and lock the vehicle.
- ▶ Keep the key out of reach of children.

⚠ WARNING Risk of accident due to incorrect gearshifting

If the engine speed is higher than the idle speed and you engage the transmission position **[D]** or **[R]**, the vehicle may accelerate sharply.

- ▶ If you engage the transmission position **[D]** or **[R]** when the vehicle is at a standstill, always depress the brake pedal firmly and do not accelerate at the same time.

Use the DIRECT SELECT lever to switch the transmission position. The current transmission position will appear on the display of the instrument cluster (→ page 178).

The shifting characteristics of the automatic transmission are designed for comfortable and economical handling. For this reason, the display of the instrument cluster shows, in addition to the transmission position display, **[C]** for Comfort.

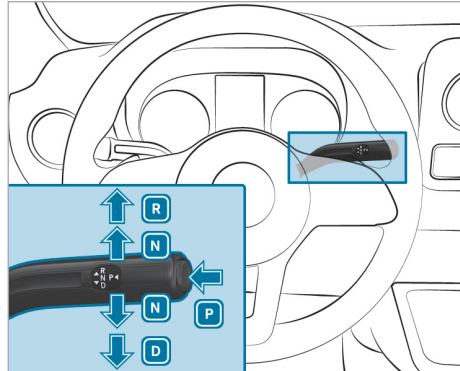

- [P]** Park position
[R] Reverse gear
[N] Neutral
[D] Drive position

Engaging reverse gear R

- ▶ Depress the brake pedal and push the DIRECT SELECT lever up past the first point of resistance. The transmission position display will show **[R]** in the instrument cluster.

Selecting neutral N

⚠ WARNING Risk of accident and injury when neutral position is engaged

If you park the vehicle with the transmission in neutral position **[N]** and the parking brake is not engaged, the vehicle may roll away.

There is a risk of accident and injury.

- ▶ Before parking the vehicle, apply the parking brake.
- ▶ Press the brake pedal and the DIRECT SELECT lever up or down to the first point of resistance. The transmission position display will show **[N]** in the instrument cluster.

Subsequently releasing the brake pedal will allow you to move the vehicle freely, e.g. to push it or tow it.

If the automatic transmission should also stay in neutral **[N] when the vehicle is switched off, carry out the following:**

- ▶ Start the vehicle.

- ▶ Depress the brake pedal and engage neutral **[N]**.
 - ▶ Release the brake pedal.
 - ▶ Switch off the vehicle.
- i** If you then leave the vehicle and the key is still in the vehicle, the automatic transmission will continue to stay in neutral **[N]**.

Engaging park position **P**

! **NOTE** Damage due to engaging park position **[P]** while the vehicle is rolling

If you shift the transmission into park position **[P]** while the vehicle is rolling, the transmission may be damaged.

- ▶ If the vehicle is rolling, do not open a door.
- ▶ Only engage park position **[P]** when the vehicle is stationary.

- ▶ Observe the notes on parking the vehicle (→ page 139).
 - ▶ Depress the brake pedal until the vehicle is stationary.
 - ▶ When the vehicle is stationary, press the **[P]** button.
If transmission position **[P]** is shown, park position is engaged. If transmission position **[P]** is not shown, apply the parking brake. Secure the vehicle against rolling away with a wheel chock or a non-sharp-edged object.
- i** Depending on the situation, it may take a short time until transmission position **[P]** is engaged. Therefore, always pay attention to the transmission position display.

Park position **[P]** will be engaged automatically if one of the following conditions is met:

- If you switch the stationary vehicle off in transmission position **[D]** or **[R]**.
- If you open the fully closed driver's door when the vehicle is stationary but transmission position **[D]** or **[R]** is engaged.
- If the vehicle is rolling and you switch it off in transmission position **[D]** or **[R]** and bring it to a standstill.
- If the HOLD function is active or the Active Distance Assist DISTRONIC system is active (vehicle stationary) and the driver leaves the driver's seat or the driver's seat belt buckle is unfastened.

- If the vehicle is rolling and you shift to transmission position **[N]**, bring the vehicle to a standstill and open the fully closed driver's door when the vehicle is stationary.
 - The engaging of park position **[P]** automatically is required by the vehicle.
- i** To maneuver with an open driver's door, open the driver's door while the vehicle is stationary and engage transmission position **[D]** or **[R]** again.

Engaging drive position **D**

- ▶ Depress the brake pedal and push the DIRECT SELECT lever down past the first point of resistance.
The transmission position display will show **[D]** in the instrument cluster.

When the automatic transmission is in transmission position **[D]**, it will shift gears automatically. This depends on the following factors:

- Position of the accelerator pedal
- Vehicle speed

Restricting the shift range

Requirements

- Transmission position **[D]** is engaged (→ page 126).

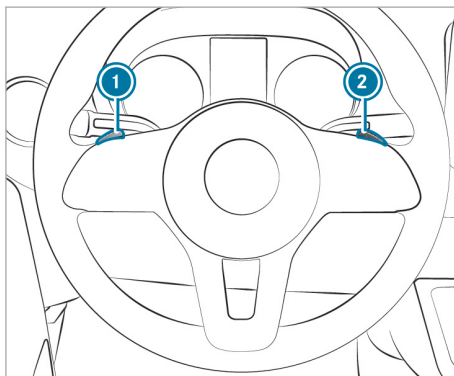

- ▶ **To restrict the shift range:** briefly pull steering wheel paddle shifter **1**.
The automatic transmission will shift to the next lower gear, depending on the gear currently engaged. The shift range will also be restricted.
The selected shift range will be shown on the instrument cluster display. The automatic

transmission will shift only as far as the selected gear.

- ▶ Pull and hold steering wheel paddle shifter ①. The automatic transmission will change to a shift range that allows easy acceleration and deceleration. To do this, the automatic transmission will shift down one or more gears and restrict the shift range.

The selected shift range will be shown on the instrument cluster display. The automatic transmission will shift only as far as the selected gear.

- ⓘ The automatic transmission will not shift down if you pull steering wheel paddle shifter ① if your speed is too high.

For vehicles with OM654 engine: The automatic transmission does not shift up if the shift range is restricted and the maximum engine speed of the restricted shift range has been reached.

For vehicles with M274 engine: If the maximum engine speed for the restricted shift range is reached and you continue to depress the accelerator pedal, the automatic transmission will shift up automatically.

- ▶ **To de-restrict the shift range:** briefly pull steering wheel paddle shifter ②.

The automatic transmission will shift to the next higher gear, depending on the gear currently engaged. This will de-restrict the shift range at the same time.

The selected shift range will be shown on the instrument cluster display. The automatic transmission will shift only as far as the selected gear.

- ▶ **To de-restrict the shift range:** pull and hold steering wheel paddle shifter ②.

or

- ▶ Engage transmission position **D** again (→ page 126).

The automatic transmission will shift up one or more gears depending on the gear currently engaged. Simultaneously, the shift range restriction is deactivated and the transmission position appears on the instrument cluster display **D**.

Recommended shift ranges for the following driving conditions:

- ③ Use the engine's braking effect.
- ② Use the engine's braking effect on downhill gradients and when driving on steep roads

and in mountainous areas as well as in arduous conditions.

- ① Use the engine's braking effect on extremely steep downhill gradients and on long downhill stretches.

Using kickdown

- ▶ **For maximum acceleration:** depress the accelerator pedal beyond the pressure point.
- ▶ Ease off the accelerator pedal once the desired speed is reached.

All-wheel drive

Notes on all-wheel drive

All-wheel drive provides a permanent drive system for all four wheels and, together with ESP®, improves the traction of your vehicle. There is smart closed-loop control of the drive torque between the front and rear axles.

Traction control for all-wheel drive also takes place via the brake system. This may cause the brake system to overheat. Decelerate or stop to let the brake system cool down.

If a wheel spins due to insufficient traction, observe the following notes:

- When starting off, make use of the assistance from the traction control integrated in ESP®. Depress the accelerator pedal as far as necessary.
- Take your foot off the accelerator pedal, slowly, while the vehicle is in motion.

In wintry road conditions, use winter tires (M+S tire) and, if necessary, snow chains (→ page 239). Only in this way can the maximum effect of all-wheel drive be achieved.

Use DSR (Downhill Speed Regulation) when driving downhill off road (→ page 150).

If you fail to adapt your driving style or if you are inattentive, the all-wheel drive system can neither reduce the risk of an accident nor override the laws of physics. The all-wheel drive system cannot take road, weather and traffic conditions into account. The all-wheel drive system is only an aid. You are responsible for maintaining a safe distance from the vehicle in front, for vehicle speed, for braking in good time and for staying in lane.

! **NOTE** Risk of damage to the drivetrain and the brake system

If you operate vehicles with all-wheel drive on a one-axle test stand, you may damage the drivetrain or the brake system.

- ▶ A function or performance test should only be carried out on a two-axle test stand.
- ▶ If you wish to operate the vehicle on such a test stand, please consult a qualified specialist workshop in advance.

! **NOTE** Risk of damage to the transfer case

If you tow the vehicle with a raised axle, the transfer case can get damaged. Such damage is not covered by Mercedes-Benz Limited Warranty.

- ▶ Never tow the vehicle with a raised axle.
- ▶ Only tow the vehicle with all wheels on the ground or fully raised.
- ▶ Note the instructions on towing the vehicle with full contact with the ground for all wheels.

Electronic level control

Function of ENR (electronic level control)

! **WARNING** Risk of becoming trapped due to the vehicle lowering

When lowering the vehicle, other people could become trapped if their limbs are between the vehicle body and the wheels or underneath the vehicle.

- ▶ Make sure nobody is underneath the vehicle or in the immediate vicinity of the wheel arches when you lower the vehicle.

! **WARNING** Risk of injury due to the jack tipping over

If you park a vehicle with air suspension, the air suspension can remain active for up to an hour, even if the vehicle is switched off. If you then raise the vehicle using the jack, the air suspension will attempt to even out the vehicle level.

The jack can tip over.

- ▶ Before raising the vehicle, press the Service button on the remote control for the air suspension. This prevents the vehicle level from being automatically readjusted or manually raised or lowered.

! **WARNING** Risk of accident due to lowered or raised chassis frame

If the chassis frame is adjusted, the braking and driving characteristics can be severely impaired. You could also exceed the permissible vehicle height.

- ▶ Adjust the driving level before driving off.

! **WARNING** Risk of accident due to a malfunction of electronic level control

The vehicle level may be too high, too low or asymmetrical.

The driving and steering characteristics of the vehicle may be noticeably different.

- ▶ Adapt your driving style to the changed driving characteristics.
- ▶ Stop, paying attention to road and traffic conditions.
- ▶ Consult a qualified specialist workshop.

! **NOTE** Risk of damage to the chassis from lowered vehicle level

If electronic level control is malfunctioning or readjusts while you are driving, the vehicle level may be lowered.

- ▶ Pay attention to the road conditions and ensure there is sufficient ground clearance.
- ▶ Drive carefully.

The level of the vehicle depends on vehicle load and the load distribution. Electronic level control adjusts the level of the rear axle automatically on vehicles with an air-sprung rear axle. The vehicle level is thereby always maintained at the driving level, regardless of vehicle load. Driving dynamics remain unaffected. The height difference between the sides of the vehicle may be up to 0.4 in (1 cm). Electronic level control is not engine-dependent and is only operational when the vehicle is switched on. The electronic level control compressor works audibly.

- ❗ If the compressor works constantly or starts up several times per minute, electronic level control is malfunctioning.

Depending on the vehicle's equipment, electronic level control switches between manual mode and automatic mode. This is dependent on the driving speed or the parking brake position.

If electronic level control switches depending on vehicle speed, manual operation is automatically activated when the vehicle is stationary. You may raise or lower the vehicle level. If you subsequently drive faster than 6 mph (10 km/h), manual mode is automatically deactivated and automatic mode sets the vehicle level.

If electronic level control switches depending on the parking brake position, manual mode is automatically activated when the parking brake is applied. You may raise or lower the vehicle level to load and unload. If you release the parking brake, manual mode is automatically deactivated and automatic mode sets the driving level.

When working on the vehicle or changing a wheel, you can deactivate electronic level control (→ page 129).

If electronic level control is malfunctioning or the vehicle level is too high or too low, a warning tone sounds.

The driving and steering characteristics of the vehicle will be noticeably different. Electronic level control adjusts the vehicle level to the normal level as soon as possible. Drive on carefully until the warning tone stops. Only then is the vehicle at normal level.

To restore the vehicle level, automatic mode and electronic level control automatically switch on again depending on the option selected:

- when the parking brake is released
- from speeds of approximately 6 mph (10 km/h)

If the electronic level control compressor is in danger of overheating, for example, due to repeated raising or lowering within a short period, electronic level control is deactivated. You can raise or lower the vehicle level again after a few minutes.

Raising and lowering the vehicle level

Using the remote control

- ❗ Certain special equipment enables other operation options:
 - Ambulance: raising the vehicle level above the driving level (center position) is not possible. Only the lowest position and the driving level can be set.
 - Speed signal: in order to operate electronic level control, the parking brake must not be applied. Electronic level control can be operated manually up to 6.2 mph (10 km/h). If this speed is exceeded, driving level will be set automatically.
 - 30-minute run-on module: electronic level control can be operated up to 30 minutes after switching off the vehicle.

The remote control is located in a holder on the B-pillar on the driver's side. Remove the remote control from the holder before use.

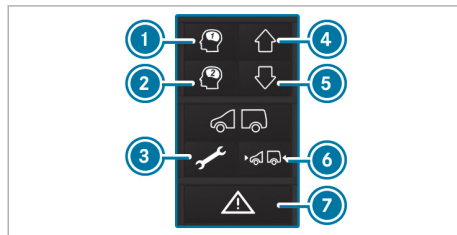

Electronic level control starts automatically if the vehicle is switched on. Operation is only possible after the parking brake has been applied.

Electronic level control performs a self-check regularly when it is activated and while in use. Indicator lamp 7 on the remote control lights up for about one second when you switch on the vehicle.

There is a malfunction if indicator lamp 7 behaves in the following ways:

- the indicator lamp does not light up when you switch on the vehicle
- or
- the indicator lamp then lights up again or flashes

In addition, a warning tone is emitted from the remote control for approximately 30 seconds. The malfunction that has been detected can be shown using the indicator lamps (signaling of malfunction codes).

▶ Park the vehicle safely and leave it switched on.

▶ Apply the parking brake.

▶ **To raise or lower the vehicle level:** press and hold button ④ or ⑤ until the vehicle level reaches the required height.

The indicator lamp on button ④ or ⑤ flashes as long as the vehicle level is being changed. When the vehicle level has been set, the indicator lamp on button ④ or ⑤ lights up.

▶ **To lower automatically:** briefly press button ⑤.

Electronic level control automatically lowers the vehicle to the next lower position:

- From the highest position to driving level
- From driving level to the lowest position

The indicator lamp on button ⑤ flashes as long as the vehicle level is being changed. When the vehicle level has been set, the indicator lamp on button ⑤ lights up.

① By pressing button ④ during the movement, the original position will be reset.

▶ **To raise automatically:** briefly press button ④.

Electronic level control automatically raises the vehicle to the next higher position:

- From the lowest position to driving level
- From driving level to the highest position

The indicator lamp on button ④ flashes as long as the vehicle level is being changed. When the vehicle level has been set, the indicator lamp on button ④ lights up.

① By pressing button ⑤ during the movement, the original position will be reset.

▶ **To raise or lower automatically to driving level (center position):** press and hold button ⑥.

Electronic level control automatically raises or lowers the vehicle to driving level.

▶ **To save the set vehicle level:** set the required vehicle level.

▶ Press and hold button ① or ② until you hear a warning tone.

The vehicle level set has been saved on corresponding button ① or ②.

▶ **To call up the saved vehicle level:** briefly press button ① or ②.

Electronic level control automatically raises or lowers the vehicle to the saved driving level.

The indicator lamp on button ① or ② flashes as long as the vehicle level is being changed. When the vehicle level has been set, the indicator lamp on button ① or ② lights up.

① Service mode may only be activated or deactivated at a qualified specialist workshop by trained personnel. In service mode, the air suspension system is deactivated for maintenance or error detection.

▶ **To activate service mode:** press button ③. Service mode is active and the indicator lamp in button ③ lights up continuously.

▶ **To deactivate service mode:** press button ③. Service mode is deactivated and the indicator lamp in button ③ goes out.

▶ **To switch on automatic mode:** drive at over 6.2 mph (10 km/h) or release the parking brake. Electronic level control controls the vehicle level automatically.

Using the button in the switch panel

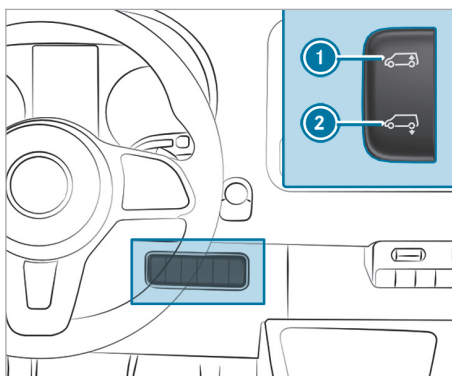

▶ Park the vehicle safely and leave it switched on.

▶ Apply the parking brake.

▶ **To raise or lower the vehicle level:** press and hold button ① or ② until the vehicle level reaches the required height.

▶ **To lower automatically:** briefly press the lower section of switch ②.

Electronic level control automatically lowers the vehicle to the next lower position:

- From the highest position to driving level
- From driving level to the lowest position

i By pressing button **1** during the movement, the original position will be reset.

▶ **To raise automatically:** briefly press the lower section of switch **1**.

Electronic level control automatically raises the vehicle to the next higher position:

- From the lowest position to driving level
- From driving level to the highest position

i By pressing button **2** during the movement, the original position will be reset.

▶ **To switch on automatic mode:** drive at over 6.2 mph (10 km/h) or release the parking brake.

Electronic level control controls the vehicle level automatically.

Using the button in the rear

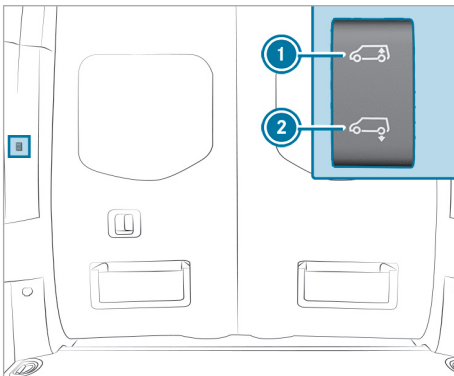

▶ Park the vehicle safely and leave the vehicle switched on.

▶ Apply the parking brake.

▶ **To raise or lower the vehicle level:** press and hold button **1** or **2** until the vehicle level reaches the required height.

▶ **To lower automatically:** briefly press the lower section of switch **2**.

Electronic level control automatically lowers the vehicle to the next lower position:

- From the highest position to driving level
- From driving level to the lowest position

i By pressing button **1** during the movement, the original position will be reset.

▶ **To raise automatically:** briefly press the lower section of switch **1**.

Electronic level control automatically raises the vehicle to the next higher position:

- From the lowest position to driving level
- From driving level to the highest position

i By pressing button **2** during the movement, the original position will be reset.

▶ **To switch on automatic mode:** drive at over 6.2 mph (10 km/h) or release the parking brake.

Electronic level control controls the vehicle level automatically.

Using electronic level control for charging with air in an emergency

! **NOTE** Damage due to excess pressure

If the pressure in the air suspension bellows is too high, the compressed-air lines or the air suspension bellows can be damaged.

▶ In doing so, do not exceed the maximum permissible operating pressure of 0.113 ksi (900 kPa (9 bar/130 psi)).

Only for vehicles with valves for electronic level control emergency charging: if electronic level control is malfunctioning and the vehicle is leaning, you can raise or lower the vehicle by connecting an external compressed-air source to one of the emergency valves (similarly to tire valves). If electronic level control is not operational, you can drive on carefully to the nearest qualified specialist workshop and have the malfunction remedied.

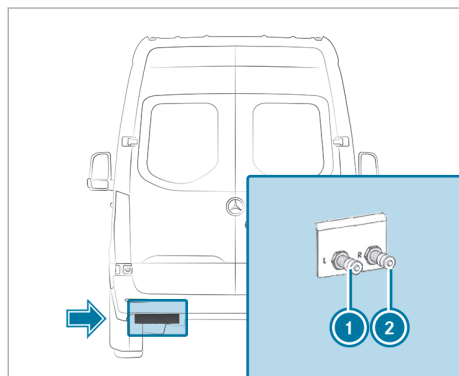

▶ Apply the parking brake.

- ▶ **Vehicles with automatic transmission:** shift the transmission to position **P**.
- ▶ Switch off the vehicle.
- ▶ Turn the valve cap of the corresponding valve (① L = left, ② R = right).
- ▶ Stand to the side of the vehicle when connecting the external compressed-air source.
- ▶ Raise or lower the vehicle level by charging or releasing compressed air until the driving level has been reached and the vehicle is in a horizontal position. While doing so, ensure you observe the maximum permissible operating pressure of 900 kPa (9 bar/130 psi).
- ▶ Disconnect the external compressed-air source.
- ▶ Tighten the valve cap on the valve (① L = left, ② R = right).
- ▶ Drive on carefully to the nearest qualified specialist workshop.

Rectifying problems with the electronic level control

You cannot raise or lower the vehicle level when stationary

Possible cause:

- The compressor is in danger of overheating. After repeatedly raising and lowering the vehicle, electronic level control play protection is deactivated.
- ▶ Try to set the vehicle level manually again after approximately one minute.

or

Possible cause:

- Electric level control has been deactivated due to undervoltage. The battery may not be charging.

Handling and ride comfort may suffer.

- ▶ Start the vehicle.
- ▶ Consult a qualified specialist workshop as soon as possible.

Refueling

Refueling the vehicle

- ⚠ **WARNING** Risk of fire or explosion from fuel

Fuels are highly flammable.

- ▶ Fire, open flames, smoking and creating sparks must be avoided.
- ▶ Before refueling, switch off the vehicle and, if installed, the stationary heater, and leave them switched off during refueling.

- ⚠ **WARNING** Risk of injury from fuels

Fuels are poisonous and hazardous to your health.

- ▶ Do not swallow fuel or let it come into contact with skin, eyes or clothing.
- ▶ Do not inhale fuel vapor.
- ▶ Keep children away from fuel.
- ▶ Keep doors and windows closed during the refueling process.

If you or other people come into contact with fuel, observe the following:

- ▶ Immediately rinse fuel off your skin with soap and water.
- ▶ If fuel comes into contact with your eyes, immediately rinse them thoroughly with clean water. Seek medical attention immediately.
- ▶ If you swallow fuel, seek medical attention immediately. Do not induce vomiting.
- ▶ Change immediately out of clothing that has come into contact with fuel.

- ⚠ **WARNING** Risk of fire and explosion due to electrostatic charge

Electrostatic charge can ignite fuel vapor.

- ▶ Before you open the fuel filler cap or take hold of the pump nozzle, touch the metallic vehicle body.
- ▶ To avoid creating another electrostatic charge, do not get into the vehicle again during the refueling process.

⚠ WARNING Risk of fire from fuel mixture

Vehicles with a diesel engine:

If you mix diesel fuel with gasoline, the flash point of the fuel mixture is lower than that of pure diesel fuel.

While the vehicle is running, component parts in the exhaust system may overheat without warning.

- ▶ Never refuel using gasoline.
- ▶ Never mix gasoline with diesel fuel.

! NOTE Do not use diesel to refuel vehicles with a gasoline engine

If you have accidentally refueled with the wrong fuel:

- Do not switch on the vehicle. Otherwise fuel can enter the engine.
- Even small amounts of the wrong fuel could result in damage to the fuel system and the engine. The repair costs are high.

- ▶ Consult a qualified specialist workshop.
- ▶ Have the fuel tank and fuel lines drained completely.

! NOTE Do not use gasoline to refuel vehicles with a diesel engine

If you have accidentally refueled with the wrong fuel:

- Do not switch on the vehicle. Otherwise, fuel can enter the fuel system.
- Even small amounts of the wrong fuel could result in damage to the fuel system and the engine. The repair costs are high.

- ▶ Consult a qualified specialist workshop.
- ▶ Have the fuel tank and fuel lines drained completely.

! NOTE Damage to the fuel system caused by overfilled fuel tanks

- ▶ Only fill the fuel tank until the pump nozzle switches off.

! NOTE Fuel may spray out when you remove the fuel pump nozzle

- ▶ Only fill the fuel tank until the pump nozzle switches off.

! NOTE Damage to painted surfaces due to fuel

- ▶ Do not spill any fuel on painted surfaces.

🔥 ENVIRONMENTAL NOTE Environmental damage due to improper handling of fuel

If fuels are handled improperly, they pose a danger to persons and the environment.

- ▶ Do not allow fuels to run into the sewage system, the surface waters, the ground water or into the ground.

Requirements:

- The vehicle is unlocked.
 - The auxiliary heating is switched off.
 - The vehicle is switched off.
 - The front left-hand door is open.
- i** Do not get back into the vehicle during the refueling process. Otherwise, electrostatic charge could build up again.

Observe the notes on operating fluids (→ page 270).

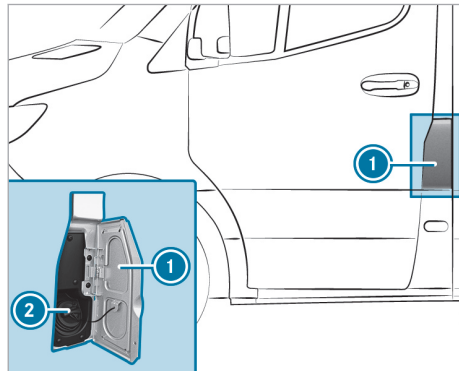

- ① Fuel filler flap
- ② Fuel filler cap

- i** The fuel filler flap is beside the front left-hand door when viewed in the direction of travel. The position of the fuel filler cap is also shown on the instrument cluster . The arrow on the filling pump specifies the side of the vehicle.

- ▶ Open fuel filler flap ①.
- ▶ Turn fuel filler cap ② counter-clockwise and remove it.

- ▶ Close all vehicle doors to prevent fuel vapors from entering the vehicle interior.
- ▶ Completely slide the filler neck of the pump nozzle into the tank, hook in place and refuel.
- ▶ Fill the fuel tank only until the pump nozzle switches off.
- ▶ Replace fuel filler cap ② and turn it clockwise. You will hear a click when the fuel filler cap is closed fully.
- ▶ Open the front left-hand door.
- ▶ Close fuel filler flap ①.

- ① **Vehicles with a diesel engine and incorrect fueling protector against refueling with gasoline:** the filler neck is designed for refueling at diesel filling pumps for passenger vehicles.
- ② **Vehicles with a diesel engine without an incorrect fueling protector:** refueling preferred at diesel filling pumps for passenger vehicles. However, you can also refuel at a diesel filling pump for trucks.
- ③ If the fuel tank has been run completely dry, add at least 1.3 gal (5 l) of fuel.
- ④ Vehicles that can use a mixture of fuels can be recognized by the sticker "Ethanol up to E85!" on the fuel filler flap.

Rectifying problems with the fuel and fuel tank

Fuel is leaking from the vehicle

Possible cause:

- The fuel line or the fuel tank is defective.
- ▶ Apply the parking brake.
- ▶ Switch off the vehicle.
- ▶ Open the driver's door. The tow position is set to **0**.
- ▶ Under no circumstances restart the vehicle!
- ▶ Contact a qualified specialist workshop.
- ▶ Take measures to contain leaked fuel.

The vehicle does not start

Possible cause:

- The fuel tank is completely empty.
- ▶ Refuel the vehicle with at least 1.3 gal (5 l) of fuel.
- ▶ Switch on the vehicle for approx. ten seconds.
- ▶ Start the vehicle continuously for a maximum of ten seconds until it runs smoothly.

If the vehicle does not start:

- ▶ Switch on the vehicle again for approx. ten seconds.
- ▶ Start the vehicle again continuously for a maximum of ten seconds until it runs smoothly.

If the vehicle does not start after three attempts:

- ▶ Contact a qualified specialist workshop.

DEF®

Notes on DEF®

! **NOTE** Irritation to skin, eyes and respiratory tract due to DEF

DEF can cause irritation if inhaled or ingested, or if it comes in contact with eyes or skin. When the tank is open, ammonia vapor can escape.

- ▶ Do not inhale or ingest DEF.
- ▶ Make sure DEF does not come into contact with your skin, eyes or clothing.
- ▶ Keep DEF away from children.
- ▶ Only fill the DEF tank in well-ventilated areas.

If a person comes into contact with DEF, observe the following:

- If you have ingested DEF, drink plenty of water and seek medical attention immediately.
- If DEF has come into contact with your eyes, rinse them for 15 minutes, also beneath the eyelids.
- Immediately rinse DEF off your skin with soap and water.

! **NOTE** Damage and malfunctions caused by impurities in DEF

Impurities in DEF result in the following:

- Higher emission values
- Damage to the catalytic converter
- Engine damage
- Malfunctions in the DEF exhaust gas after-treatment system
- ▶ Avoid impurities in DEF.

! **NOTE** Soiling due to crystallized DEF residue

DEF residue crystallizes after some time.

- ▶ When refilling DEF, immediately rinse any surfaces that it comes into contact with and remove all DEF residue.
- ▶ DEF can also be removed with a damp cloth and cold water.
- ▶ If DEF has already crystallized, clean using a sponge and cold water.

🌿 ENVIRONMENTAL NOTE Soiling with DEF

DEF residue crystallizes after some time and stain the affected surfaces.

- ▶ Immediately rinse surfaces that come in contact with DEF when filling with water or remove DEF with a damp cloth and cold water.

If DEF has already crystallized, clean using a sponge and cold water.

DEF[®] is a liquid urea solution used for exhaust gas aftertreatment for diesel engines. In order for exhaust gas aftertreatment to function properly, use only DEF[®] in accordance with ISO 22241.

DEF[®] has the following properties:

- non-toxic
- colorless and odorless
- non-flammable

DEF[®] availability:

- You can use the express service to have DEF[®] refilled at a qualified specialist workshop, e.g. an authorized Mercedes-Benz Center.
- DEF[®] is available at numerous gas stations from DEF[®] filling pumps.
- Alternatively, DEF[®] is available at qualified specialist workshops, e.g. an authorized Mercedes-Benz Center, and at numerous gas stations as a DEF[®] refill canister or DEF[®] refill bottle.

- i** DEF[®] freezes at a temperature of approximately 12.2°F (-11°C). The vehicle is equipped with a DEF[®] preheating system at the factory. This means that winter operation is also ensured at temperatures below 12.2°F (-11°C). If you add DEF[®] at temperatures below 12.2°F (-11°C), the DEF[®] level may not

be displayed correctly on the instrument cluster. If the DEF[®] is frozen, drive for at least 20 minutes and then park the vehicle for a minimum of 30 seconds, so that the level is correctly displayed. In extreme winter conditions, the time needed to detect the amount added may be considerably longer. Park the vehicle in a warm garage to speed up this process.

- i** When using refill containers, ensure a non-drip connection to the vehicle filler neck.

Calling up the DEF[®] level gauge

On-board computer:

→ **Service**

- ▶ Select **Additive (DEF)** and confirm. The DEF[®] level will appear.

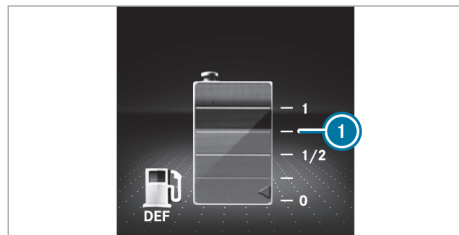

Instrument cluster with display (color)

- 1** DEF[®] level

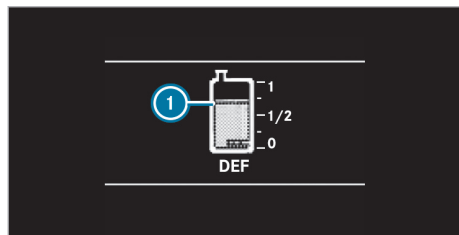

Instrument cluster with display (black and white)

- 1** DEF[®] level

Topping up DEF[®]

! **NOTE** Engine damage due to DEF being in the fuel

- ▶ DEF must not be used to fill the fuel tank.
- ▶ Only use DEF to fill the DEF tank.
- ▶ Do not overfill the DEF tank.

I NOTE Contamination of the vehicle interior due to DEF leakage

- ▶ After adding, carefully close the DEF refill container.
- ▶ Avoid carrying DEF refill containers permanently in the vehicle.

Requirements

- The vehicle must be turned off.

The following messages that appear in succession on the instrument cluster display indicate that you need to add DEF[®] to the tank:

- **Refill Additive See Operator's Manual**

The DEF[®] level has fallen below the first warning threshold.

- **Refill Additive (DEF) Starts until Emerg. Op.: XXX See Operator's Manual**

The DEF[®] level has fallen into the reserve range.

After the first message, the remaining amount of DEF[®] is sufficient for about 1200 mi (1900 km) and you will be able to start the engine a further 16 times. The number of remaining possible restarts "XX" (16 to 1) is shown in the message for every restart.

- **Refill Additive Emer. Op.: Max. XXX mph See Operator's Manual**

You can drive the vehicle only at a maximum speed of 5 mph (8 km/h).

Top-up quantity:

With a prompt on the display	min. 8 l
Without a prompt on the display	min. 2 l

You can also have the DEF[®] level displayed (→ page 135).

Opening the DEF[®] filler cap on filler caps that are not lockable

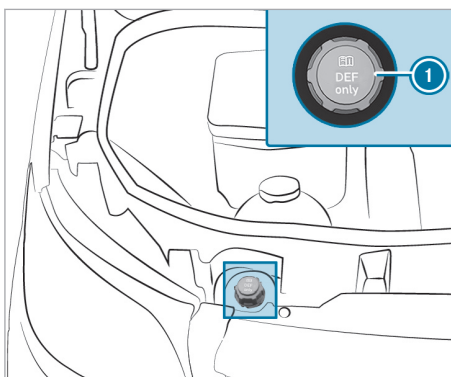

- ▶ Open the hood.
- ▶ Turn DEF[®] filler cap ① counter-clockwise and remove it.

Opening the DEF[®] filler cap on lockable filler caps

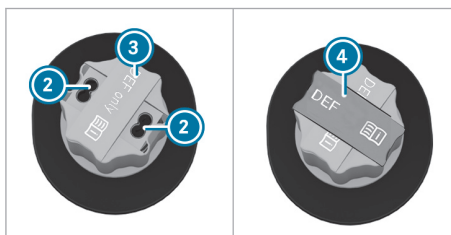
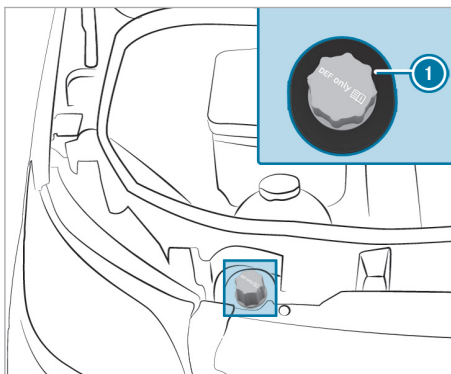

- ▶ Open the hood.
- ▶ Take tool ④ for unlocking DEF[®] filler cap ① from the vehicle tool kit.

- ▶ Pull cover ③ on DEF[®] filler cap ① up, turn 90° and release it.
- ▶ Insert tool ④ in holes ② of DEF[®] filler cap ①.
- ▶ Turn DEF[®] filler cap ① counter-clockwise and remove it.

Preparing the DEF[®] refill canister

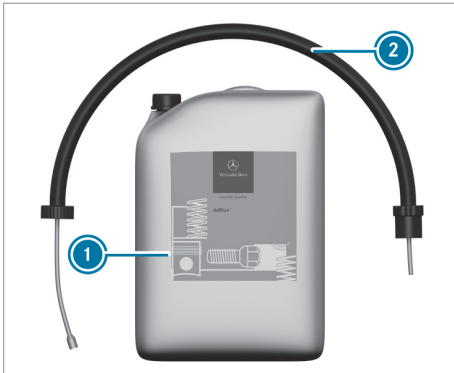

Variant 1



Variant 2

- ▶ Unscrew the cap on DEF[®] refill canister ①.
- ▶ Screw disposable hose ② onto the opening of the DEF[®] refill canister ① until hand-tight.

Topping up DEF[®]

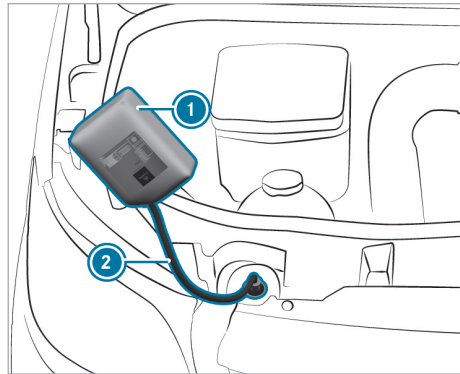

Variant 1

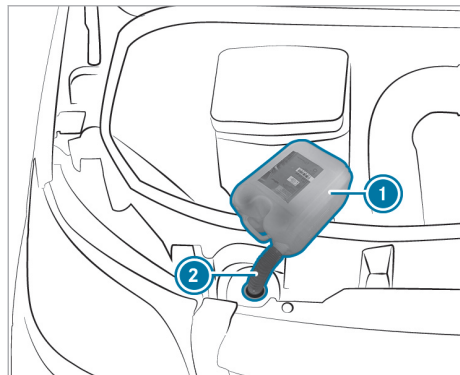

Variant 2

- ▶ Screw on hand-tight (variant 1) or insert (variant 2) disposable hose ② into the filler neck of the vehicle.
- ▶ Lift up and tip DEF[®] refill canister ①. The filling process stops when the DEF[®] tank is completely full. DEF[®] refill canister ① can be removed when it has been only partially emptied.
- ▶ Unscrew disposable hose ② and close the DEF[®] and refill canister ① in reverse order.
- ▶ Switch on the vehicle for at least 60 seconds.
- ▶ Start the vehicle.

ⓘ Avoid storing DEF[®] containers permanently in the vehicle.

DEF® refill bottle

Screw the DEF® refill bottle only hand-tight onto the filler opening in the engine compartment. It may otherwise be damaged.



DEF® refill bottles ① can be obtained at many gas stations or at a qualified specialist workshop. Refill bottles without a threaded cap offer no overfill protection. DEF® may leak out as a result of overfilling. Mercedes-Benz offers special refill bottles with a threaded cap. You can obtain these from an authorized Mercedes-Benz Center.

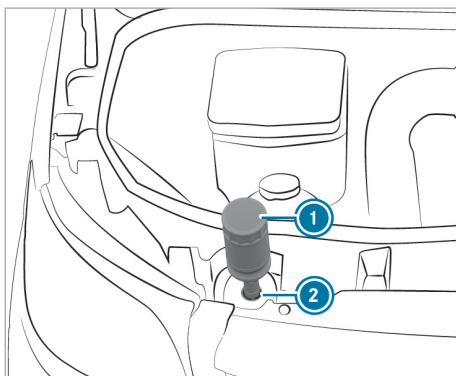

- ▶ Unscrew the protective cap from DEF® refill bottle ①.
- ▶ Place DEF® refill bottle ① as shown on filler opening ② and screw it on clockwise until hand-tight.
- ▶ Press DEF® refill bottle ① towards filler opening ②.
The DEF® tank is filled. This could take up to one minute.

- ① When the DEF® refill bottle is no longer pressed down, filling stops. The bottle can be removed when it has been only partially emptied.

- ▶ Let go of DEF® refill bottle ①.
- ▶ Turn DEF® refill bottle ① counter-clockwise and remove it.
- ▶ Screw the protective cap onto the DEF® refill bottle ① again.

Filling procedure with the pump nozzle of a DEF® filling pump

- ▶ Insert the pump nozzle into the filler neck and add DEF®. When doing so, do not overfill the DEF® tank. You can also use a DEF® filling pump for trucks.

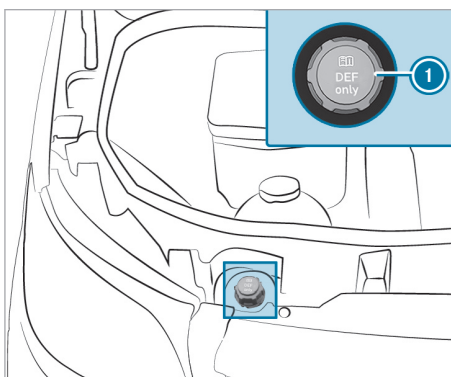
Closing the DEF® filler cap on filler caps that are not lockable

- ▶ After filling the DEF® tank, place DEF® filler cap ① on the filler neck and tighten by turning it clockwise.
- ▶ Turn the DEF® filler cap until the lettering is legible and horizontal.
The filler neck is locked correctly only when this is the case.
- ▶ Close the hood.

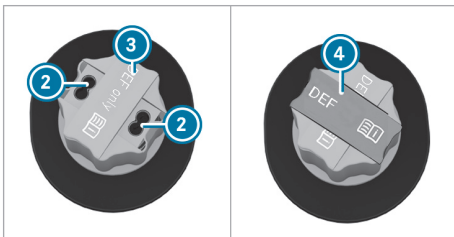
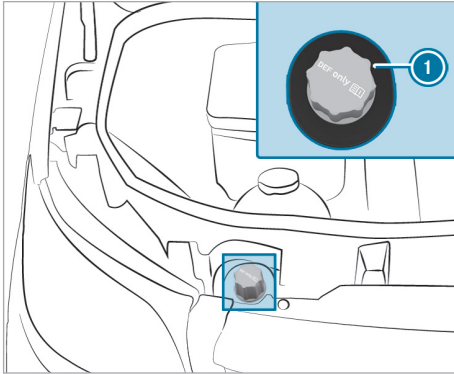
Closing the DEF[®] filler cap on lockable filler caps

- ▶ After filling the DEF[®] tank, place DEF[®] filler cap ① on the filler neck and tighten by turning it clockwise.
- ▶ Remove tool ④ from DEF[®] filler cap ① and store it in the vehicle tool kit.
- ▶ Pull cover ③ on DEF[®] filler cap ① up, rotate over the holes ② of DEF[®] filler cap ①, and release.
- ▶ Turn DEF[®] filler cap ①.
If DEF[®] filler cap ① turns freely, the DEF[®] tank is closed.

Parking

Parking the vehicle

- ⚠ **WARNING** Risk of fire caused by hot exhaust system parts

Flammable materials such as leaves, grass or twigs may ignite.

- ▶ Park the vehicle so that no flammable material can come into contact with hot vehicle components.

- ▶ In particular, do not park on dry grass-land or harvested grain fields.

- ⚠ **WARNING** Risk of accident and injury due to children left unattended in the vehicle

If you leave children unattended in the vehicle, they could, in particular:

- open doors, thereby endangering other persons or road users.
- get out and be struck by oncoming traffic.
- operate vehicle equipment and become trapped, for example.

In addition, the children could also set the vehicle in motion by, for example:

- releasing the parking brake.
- changing the gearbox position.
- starting the vehicle.

- ▶ Never leave children unattended in the vehicle.
- ▶ When leaving the vehicle, always take the key with you and lock the vehicle.
- ▶ Keep the key out of reach of children.

- ⚠ **WARNING** Risk of accident and injury caused by an insufficiently secured vehicle rolling away

If the vehicle is not securely parked sufficiently, it can roll away in an uncontrolled way even at a slight downhill gradient.

- ▶ On uphill or downhill gradients, turn the front wheels so that the vehicle rolls towards the curb if it starts moving.
- ▶ Apply the parking brake.
- ▶ Vehicles with automatic transmission: shift the transmission to position **P**.
- ▶ Vehicles with manual transmission: engage first **1** or reverse gear **R**.

- ⓘ **NOTE** Damage to the vehicle or the drivetrain due to rolling away

- ▶ Always park your vehicle safely and according to legal requirements.
- ▶ Always properly secure the vehicle against rolling away.

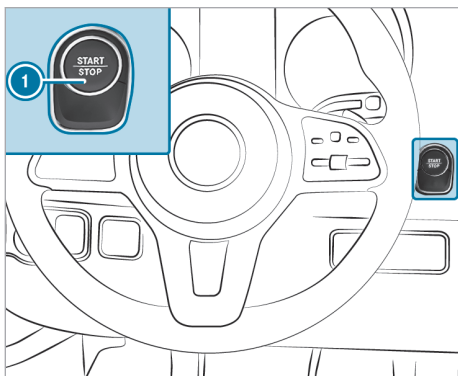

To ensure that the vehicle is properly secured against rolling away unintentionally, observe the following points.

- ▶ Always apply the parking brake.
- ▶ **On uphill or downhill gradients:** turn the front wheels towards the curb.
- ▶ **Vehicles with automatic transmission:** shift to transmission position **P**.
- ▶ Switch off the vehicle by pressing button **1**.
- ▶ Get out of the vehicle and lock it.
- ▶ **On uphill or downhill gradients:** secure the rear axle with a chock or an object without any sharp edges.

Manual parking brake

Applying or releasing the parking brake lever

⚠ WARNING Risk of skidding or an accident by braking with the parking brake

If you have to brake your vehicle with the parking brake, the braking distance is considerably longer and the wheels may lock. There is an increased risk of skidding and/or accident.

- ▶ Only brake the vehicle with the parking brake if the service brake has failed.
- ▶ In this case, do not apply the parking brake with too much force.
- ▶ If the wheels lock, immediately release the parking brake as much as required for the wheels to turn again.

⚠ WARNING Risk of fire and an accident if the parking brake is not released

If the parking brake is not fully released when driving, the following situations can occur:

- The parking brake can overheat and cause a fire
 - The parking brake can lose its holding function
- ▶ Completely release the parking brake before driving off.

The brake lights do not light up when you brake the vehicle with the parking brake.

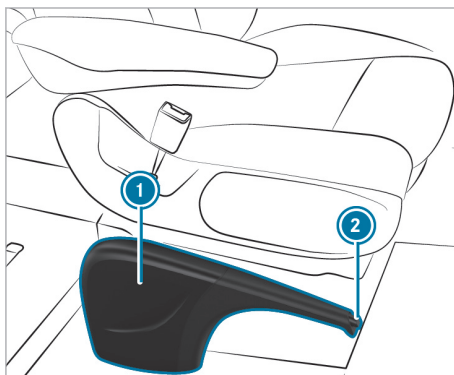

Generally, you may only apply the parking brake when the vehicle is stationary.

- ▶ **To apply the parking brake:** pull handbrake lever **1** up as far as the last possible detent. When the vehicle has been started, the **PARK** and **(P)** (USA) or **(P)** (Canada) indicator lamps in the instrument cluster light up. If the vehicle is in motion, a warning tone sounds.

i In vehicles with a folding parking brake lever, you can then press parking brake lever **1** down as far as it will go.

- ▶ **To release the parking brake:** on vehicles with a folding handbrake lever, first pull handbrake lever **1** up as far as it will go.
- ▶ Pull parking brake lever **1** slightly and press release knob **2**.
- ▶ Guide handbrake lever **1** down as far as it will go with release knob **2** pressed. The **PARK** and **(P)** (USA) or **(P)** (Canada) indicator lamps in the instrument cluster go out.

Folding the handbrake lever up or down (only in vehicles with a folding handbrake lever)

Requirements:

- The handbrake lever is applied.
- ▶ **To fold down the handbrake lever:** push the handbrake lever down as far as it will go.
- ▶ **To fold up the handbrake lever:** pull the handbrake lever up as far as it will go.

Performing emergency braking with the parking brake lever

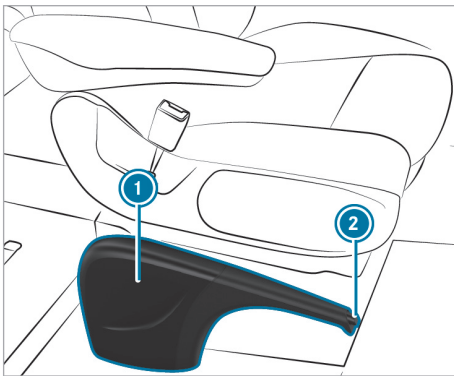

If, in exceptional cases, the service brake fails, you can use the parking brake to perform emergency braking.

- ▶ **Emergency braking:** press and hold release button ② and carefully pull parking brake lever ①.

Electric parking brake

Information on the electric parking brake

⚠ WARNING Risk of accident and injury due to children left unattended in the vehicle

If you leave children unattended in the vehicle, they could, in particular:

- open doors, thereby endangering other persons or road users.
- get out and be struck by oncoming traffic.
- operate vehicle equipment and become trapped, for example.

In addition, the children could also set the vehicle in motion by, for example:

- releasing the parking brake.
- changing the gearbox position.
- starting the vehicle.
- ▶ Never leave children unattended in the vehicle.
- ▶ When leaving the vehicle, always take the key with you and lock the vehicle.
- ▶ Keep the key out of reach of children.



Observe the note on transporting animals in the vehicle (→ page 38).

For the automatic functions to work correctly, the driver must be seated in the correct seat position (→ page 68).

The function of the electric parking brake is dependent on the on-board electrical system voltage. If the on-board electrical system voltage is low or there is a malfunction in the system, the electric parking brake may not be able to be applied. In this case, the yellow  indicator lamp lights up.

In this case, park the vehicle in the following way:

- Park the vehicle on level ground and secure it to prevent it from rolling away.
- **Vehicles with automatic transmission:** shift the transmission to position **P**.

i The electric parking brake is only actually applied when the red **PARK** and  (USA) indicator lamps or the red  (Canada) indicator lamps light up continuously.

It may not be possible to release a parking brake if the on-board electrical system voltage is low or if there is a malfunction in the system. Inform a qualified specialist workshop.

When the vehicle is stationary, the electric parking brake carries out a function test at regular intervals. Noises are normal in this process.

The automatic application of the parking brake only works after a previous journey.

Function of the electric parking brake

Vehicles with automatic transmission:

When the vehicle is switched off after a journey and the transmission is in position **P**, the electric parking brake is automatically applied.

In addition, at least one of the following conditions must be fulfilled:

- the driver is not sitting in the driver's seat
- the belt buckle is undone

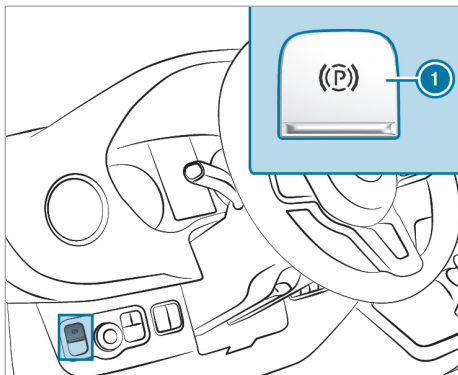

The electric parking brake is also automatically applied if Active Distance Assist DISTRONIC has brought the vehicle to a standstill and the driver is not sitting in the driver's seat.

The electric parking brake is also automatically applied when the transmission is not in position P, but the following situations occur:

- there is a system malfunction
- the power supply is insufficient
- the vehicle is stationary for a long time

The red **PARK** and **(P)** (USA) or **(P)** (Canada) indicator lamps in the instrument cluster light up. The electric parking brake is only actually applied when the red **PARK** and **(P)** (USA) or **(P)** (Canada) indicator lamps light up continuously.

i To prevent the electric parking brake from applying automatically, pull switch **1**.

■ Releasing the electric parking brake automatically

Vehicles with automatic transmission:

The electric parking brake of your vehicle is released when all of the following conditions are fulfilled:

- The driver is sitting in the driver's seat.
 - The driver is belted.
 - The vehicle has been started.
 - **D** or **R** is engaged and you depress the accelerator pedal.
- or

You shift out of **P** into **D** or **R**. You must also depress the accelerator if traveling on steep uphill gradients.

- When **R** is engaged, the rear-end doors must be closed.

■ Applying/releasing the electric parking brake manually

▲ WARNING Risk of accident and injury due to children left unattended in the vehicle

If you leave children unattended in the vehicle, they could, in particular:

- open doors, thereby endangering other persons or road users.
- get out and be struck by oncoming traffic.
- operate vehicle equipment and become trapped, for example.

In addition, the children could also set the vehicle in motion by, for example:

- releasing the parking brake.
- changing the gearbox position.
- starting the vehicle.

- ▶ Never leave children unattended in the vehicle.
- ▶ When leaving the vehicle, always take the key with you and lock the vehicle.
- ▶ Keep the key out of reach of children.

- Observe "Notes on pets in the vehicle" (→ page 38).

▶ To apply: press the **(P)** switch when the vehicle is stationary.

When the electric parking brake is applied, the red **PARK** and **(P)** (USA) or **(P)** (Canada) indicator lamps light up in the instrument cluster. The electric parking brake is only actually applied when the red **PARK** and **(P)** (USA) or **(P)** (Canada) indicator lamps light up continuously.

It is also possible to apply the electric parking brake when the vehicle is switched off.



▶ To release: pull the **(P)** switch.

The red **PARK** and **(P)** (USA) or **(P)** (Canada) indicator lamps in the instrument cluster go out.

You may only release the electric parking brake if the vehicle is switched on with the start/stop button.

Emergency braking



In the event of an emergency, you can brake the vehicle while it is in motion with the electric parking brake.

- ▶ While driving, press the  switch of the electric parking brake.
The vehicle is braked as long as you keep the  switch of the electric parking brake depressed.

The vehicle's brake lights light up.

The longer the  switch of the electric parking brake is depressed, the greater the braking force.

During the braking procedure, you will receive the following feedback from the vehicle:

- A warning tone sounds.
- The **Release Parking Brake** message appears in the instrument cluster.
- The red  and  (USA) indicator lamps flash in the instrument cluster or the red  (Canada) indicator lamp flashes in the instrument cluster.

When the vehicle has been braked to a standstill, the electric parking brake is applied.

Laying up the vehicle

! **NOTE** Damage to the starter battery due to leaving the vehicle idle for extended periods of time

If the vehicle is not moved for a longer period, quiescent current can lead to excessive discharge of the starter battery and cause battery damage.

- ▶ Charge the starter battery if the voltage is below 12.2 V, for example, after driving for an extended period.
- ▶ Charge the starter battery every six months, even if it has been disconnected.
- ▶ Check the starter battery charge level every four weeks if no trickle charger is being used.
- ▶ If possible, connect a trickle charger via a jump-start connection point.
- ▶ Consult a qualified specialist workshop to disconnect the battery or if you have any questions.

Parking up the vehicle for over four weeks



- ▶ **Method 1:** connect the batteries to a trickle charger via the jump-start connection.
- ▶ **Method 2:** disconnect all batteries. For this, please contact a qualified specialist workshop.

Using the chock

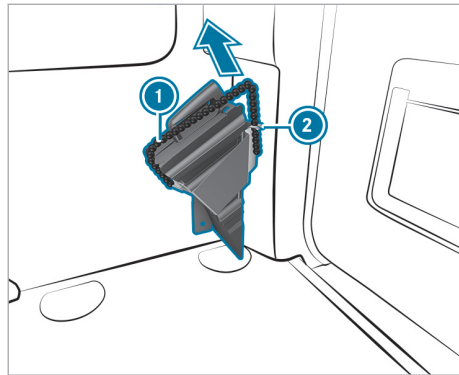
Use the chock to provide additional safety to prevent the vehicle from rolling away, e.g. when parking or changing a wheel.



Chock in load/passenger compartment

- ▶ **To remove the chock:** pull holding rope  slightly downwards and then remove it from holder .
- ▶ Remove the chock.
- ⓘ When stowing it away, ensure that the chock is secured in the holder by holding rope .

Driving and driving safety systems

Notes on driving systems and your responsibility

Your vehicle is equipped with driving systems that assist you in driving, parking and maneuvering the vehicle. The driving systems are only aids. They are not a substitute for you paying attention to your surroundings and do not relieve you of your responsibility pertaining to road traffic law. The driver is always responsible for maintaining a safe distance to the vehicle in front, for vehicle speed, for braking in good time and for staying in lane. Always pay attention to the traffic and intervene if necessary. Be aware of the limitations regarding the safe use of these systems.

Driving systems can neither reduce the risk of accident if you fail to adapt your driving style nor

override the laws of physics. They cannot always take into account road, weather or traffic conditions.

- ❶ Some driving systems can regulate or limit the speed to a previously set value. If there is a change of drivers, make sure that you inform the new driver about the set cruise speed.

Information about sensors

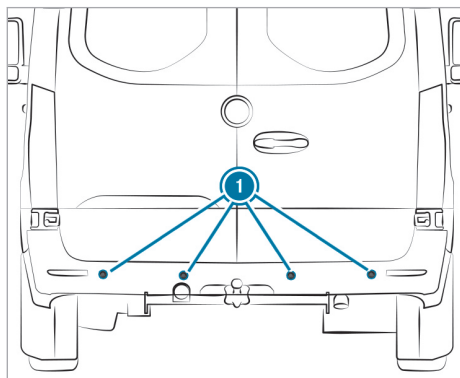

Certain driving and driving safety systems use sensors ❶ to monitor the area in front of, behind or next to the vehicle (depending on the vehicle's equipment).

Depending on the vehicle's equipment, the radar sensors are integrated behind the bumpers and/or behind the radiator shell. Keep these parts free of dirt, ice and slush (→ page 222). Do not cover the sensors with bicycle racks, overhanging loads or stickers, for example. After a collision, have the function of the radar sensors checked at a qualified specialist workshop as damage (both visible and non-visible) may have occurred to the bumper or radiator shell.

Function of driving systems and driving safety systems

In this section, you will find information about the following driving systems and driving safety systems:

- ABS (**A**nti-**l**ock **B**rake **S**ystem) (→ page 144)
- BAS (**B**rake **A**ssist **S**ystem) (→ page 145)
- ASR (**A**cceleration **S**kid **C**ontrol) (→ page 145)
- ESP® (**E**lectronic **S**tability **P**rogram) (→ page 145)

- EBD (**E**lectronic **B**rake**f**orce **D**istribution) (→ page 147)
- Active Brake Assist (→ page 147)
- Cruise control (→ page 149)
- DSR (**D**ownhill **S**peed **R**egulation) (→ page 150)
- Active Distance Assist DISTRONIC (→ page 152)
- Hill Start Assist (→ page 155)
- HOLD function (→ page 155)
- Parking Assist PARKTRONIC (→ page 156)
- Rear-view camera
- 360° Camera (→ page 159)
- ATTENTION ASSIST (→ page 162)
- Traffic Sign Assist (→ page 163)
- Blind Spot Assist (→ page 165)
- Drive Away Assist (→ page 166)
- Rear Cross Traffic Alert (→ page 167)
- Lane Keeping Assist (→ page 167)
- Active Lane Keeping Assist (→ page 168)
- ADR (**W**orking **S**peed **C**ontrol) (→ page 169)

Functions of ABS (anti-lock braking system)

Observe the important safety guidelines for the driving safety system.

ABS controls the brake pressure in critical situations:

- During braking, for instance, at maximum full-stop braking or if there is insufficient tire traction, the wheels are prevented from locking.
- The steerability of the vehicle in terms of physical possibilities is ensured when you are braking.
- ABS is active at speeds above approximately 3 mph (5 km/h). On a slippery road surface, ABS will intervene even if you brake only gently.

System limits

ABS may be impaired or may not function if a malfunction has occurred and the yellow  ABS warning lamp lights up continuously on the instrument cluster after the vehicle is started.

If ABS intervenes, you will feel pulsations in the brake pedal. The pulsating brake pedal may be an indication of hazardous road conditions and functions as a reminder to take extra care while driving.

If ABS intervenes: keep the brake pedal firmly depressed until the braking situation has passed.

To carry out maximum full-stop braking: fully depress the brake pedal.

Function of BAS (Brake Assist System)

▲ WARNING Risk of an accident caused by a malfunction in BAS (Brake Assist System)

If BAS is malfunctioning, the braking distance in an emergency braking situation is increased.

▶ Depress the brake pedal with full force in emergency braking situations. ABS prevents the wheels from locking.

BAS helps you by providing additional brake force in an emergency braking situation.

If you depress the brake pedal quickly, BAS will be activated:

- BAS will automatically boost the brake force of the brakes
- BAS can shorten the braking distance
- ABS will prevent the wheels from locking

When you release the brake pedal, the brakes will function as usual again. BAS will be deactivated.

Functions of ASR (anti-slip control)

ASR can neither reduce the risk of an accident nor override the laws of physics if the driver does not pay attention when pulling away or accelerating. ASR is only an aid. Always adapt your driving style to suit the prevailing road and weather conditions.

If you activate or deactivate all-wheel drive in a vehicle with this option, ASR will be deactivated for the duration of the activation/deactivation process.

Vehicles without steering wheel buttons: if ASR is malfunctioning, the  indicator lamp will light up while the vehicle is running and the engine output may be reduced (→ page 26).

ASR improves traction, i.e. the transfer of power from the tires to the road surface, for a sustained period and therefore also improves the driving stability of the vehicle. If the drive axle wheels start to spin, ASR will brake individual wheels on the drive axle and limit the engine torque. ASR thus assists you significantly when pulling away and accelerating, especially on wet or slippery roads.

If traction on the road surface is not sufficient, even ASR will not allow you to pull away without difficulty. The type of tires and total weight of the vehicle as well as the gradient of the road also play a crucial role.

If ASR intervenes, the  warning lamp in the instrument cluster will flash.

Function of ESP® (Electronic Stability Program)

▲ WARNING Risk of skidding if ESP® is malfunctioning

If ESP® is malfunctioning, ESP® cannot carry out vehicle stabilization. In addition, other driving safety systems are switched off.

- ▶ Drive on carefully.
- ▶ Have ESP® checked at a qualified specialist workshop.

▲ WARNING Risk of skidding if ESP® is deactivated

If you deactivate ESP®, ESP® cannot carry out vehicle stabilization.

- ▶ ESP® should only be deactivated in the following situations.

If the surface requires, temporarily deactivate ESP® when pulling away (→ page 146).

Do not operate the vehicle on a roller dynamometer (e.g. for a performance test). If you have to operate the vehicle on a roller dynamometer, consult a qualified specialist workshop beforehand.

If you activate or deactivate all-wheel drive in a vehicle with this option, ESP® will be automatically deactivated for the duration of the activation/deactivation process.

If ESP® is malfunctioning or automatically deactivated, the  warning lamp will light up yellow while the vehicle is running and the engine output may be reduced (→ page 26).

- ① Only use wheels with the recommended tire size. Only then will ESP® function properly.

ESP® can, within physical limits, monitor and improve driving stability and traction in the following situations:

- When pulling away on wet or slippery road surfaces
- When braking
- If you are driving faster than 50 mph (80 km/h) in strong crosswinds

If the vehicle is deviating from the direction desired by the driver, ESP® can stabilize the vehicle by performing the following actions:

- One or more wheels are braked
- The drive system performance is adapted depending on the situation

When ESP® is deactivated by the driver, the  warning lamp in the instrument cluster lights up continuously.

- Vehicle stabilization may be delayed
- Crosswind Assist is still active
- The wheels may start to spin
- ASR traction control is no longer active

If ESP® is deactivated by the driver, ESP® will continue to support you when braking.

If the  warning lamp in the instrument cluster flashes, one or more tires have reached their grip limit:

- Adapt your driving style to suit the prevailing road and weather conditions
- Do not deactivate ESP® under any circumstances

Activating/deactivating ESP® (Electronic Stability Program)

Multimedia system:

 **Settings** **Quick Access**

ESP

- ① ESP® can only be activated and deactivated via quick access when at least one other function is available in quick access. Otherwise, you can find ESP® in the **Assistance** menu.

Select ESP.

A prompt appears.

Select On or  Off.

If the ESP® OFF warning lamp  lights up permanently on the instrument cluster, ESP® is deactivated.

Observe the information on warning lamps and display messages that may appear on the instrument cluster.

Function of ESP® Crosswind Assist

Crosswind Assist does not react under the following conditions:

- The vehicle is subjected to severe jolts and vibrations, e.g. as a result of uneven surfaces or potholes.
- The vehicle loses traction, e.g. on snow or ice or when hydroplaning.
- The driver is performing sudden and large steering movements.

Crosswind Assist is operational again as soon as the driving conditions return to normal.

Crosswind Assist detects strong crosswind gusts that can impair the ability of your vehicle to drive straight ahead. Crosswind Assist intervenes depending on the direction and strength of the crosswind.

A stabilizing brake application helps you to keep the vehicle on track.

Information is shown on the instrument cluster in the event of a clearly perceptible intervention by Crosswind Assist.

Crosswind Assist is active above a vehicle speed of 50 mph (80 km/h) when driving straight or during slight cornering.

Function of ESP® trailer stabilization

⚠ WARNING Risk of accident in poor road and weather conditions

In poor road and weather conditions, the trailer stabilization cannot prevent lurching of the vehicle/trailer combination. Trailers with a high center of gravity may tip over before ESP® detects this.

▶ Always adapt your driving style to suit the current road and weather conditions.

ESP® trailer stabilization counteracts critical driving situations in good time and thereby provides considerable assistance when driving with a trailer. Trailer stabilization is part of ESP®.

If the sensor system and evaluation logic detect trailer swinging movements, ESP® trailer stabilization initially brakes individual vehicle wheels in a targeted manner. It thus counteracts swinging movements. If the swinging movements do not stop, the vehicle is braked until the vehicle/trailer combination is stabilized. If necessary, the vehicle's engine output is limited.

If your vehicle with trailer (vehicle/trailer combination) starts to swerve, you are able to stabilize the vehicle/trailer combination only by braking. ESP® trailer stabilization helps you to stabilize the vehicle/trailer combination in this situation.

ESP® trailer stabilization is active at speeds above approx. 40 mph (65 km/h).

If ESP® is deactivated because of a malfunction, trailer stabilization will not function.

Function of EBD (Electronic Brakeforce Distribution)

EBD has the following characteristics:

- monitoring and controlling the brake pressure on the rear wheels
- improving driving stability when braking, especially on bends

Functions of Active Brake Assist

Active Brake Assist consists of the following functions:

- Distance warning function
- Autonomous braking function
- Situation-dependent brake force boosting

Active Brake Assist can help you to minimize the risk of a collision with vehicles or pedestrians or to reduce the effects of such a collision.

If Active Brake Assist has detected a risk of collision, you will be warned visually and acoustically.

If you do not react to the visual warning or warning tone, autonomous braking may be initiated in critical situations.

If there are pedestrians and cyclists crossing: in especially critical situations, Active Brake Assist may initiate autonomous braking directly. In this case, the visual warning and warning tone will occur at the same time as the brakes are applied.

If you apply the brakes yourself in a critical situation or depress the brake pedal during autonomous braking, situation-dependent brake force boosting will occur. The brake pressure will increase up to maximum full-stop braking if necessary. Situation-dependent brake force boosting will intervene only when the brakes are applied firmly; otherwise, it will remain within the autonomous braking process.

⚠ WARNING Risk of accident in case of limited detection performance of Active Brake Assist

Active Brake Assist cannot always clearly identify objects and complex traffic situations.

Due to the system, unjustified interventions or non-interventions by Brake Assist may occur in complex driving situations. In these cases, as well as in the event of malfunctions of Active Brake Assist, the brake system continues to be available with full brake force boosting and BAS.

- ▶ Always keep a close eye on the traffic situation and do not rely solely on Active Brake Assist. Active Brake Assist is only an aid. The driver of the vehicle is responsible for maintaining a safe distance to the vehicle in front, for vehicle speed and for braking in good time.
- ▶ Be ready to brake and take evasive action if necessary.

Also observe the system limits of Active Brake Assist.

The individual subfunctions are available in the following speed ranges:

Distance warning function

The distance warning function will warn you at speeds greater than approximately 4 mph (7 km/h) if your vehicle is critically close to a vehicle or pedestrian.

An intermittent warning tone will sound and the  distance warning lamp will light up on the instrument cluster.

Brake immediately or take evasive action, provided it is safe to do so and the traffic situation allows it.

The distance warning function can assist you with an intermittent warning tone and warning lamps in the following situations:

Vehicles traveling in front	Stationary vehicles	Crossing vehicles	Crossing pedestrians/cyclists	Stationary pedestrians
Up to approx. 155 mph (250 km/h)	Up to approx. 124 mph (200 km/h)	No reaction	Up to approx. 37 mph (60 km/h)	No reaction

Autonomous braking function

The autonomous braking function may intervene at speeds starting from approximately 4 mph (7 km/h) in the following situations:

Vehicles traveling in front	Stationary vehicles	Crossing vehicles	Crossing pedestrians/cyclists	Stationary pedestrians
Up to approx. 155 mph (250 km/h)	Up to approx. 124 mph (200 km/h)	No reaction	Up to approx. 37 mph (60 km/h)	No reaction

Situation-dependent brake force boosting

Situation-dependent brake force boosting may intervene at speeds starting from approximately 4 mph (7 km/h) in the following situations:

Vehicles traveling in front	Stationary vehicles	Crossing vehicles	Crossing pedestrians/cyclists	Stationary pedestrians
Up to approx. 155 mph (250 km/h)	Up to approx. 50 mph (80 km/h)	No reaction	Up to approx. 37 mph (60 km/h)	No reaction

Canceling brake application by Active Brake Assist

You can cancel brake application by Active Brake Assist at any time by:

- Fully depressing the accelerator pedal or with kickdown.
- Fully releasing the brake pedal (only during situation-dependent brake force boosting).

Active Brake Assist may cancel brake application if one of the following conditions is fulfilled:

- You maneuver to avoid the obstacle.
- There is no longer a risk of collision.
- An obstacle is no longer detected in front of your vehicle.

System limits

The system may be impaired or may not function in the following situations:

- The sensors are affected by snow, rain, fog or heavy spray.
- The sensors are dirty, fogged up, damaged or obscured.
- The sensors are affected by interference from other radar sources, e.g. intense radar reflections in parking garages.
- If a loss of tire pressure or a defective tire has been detected and displayed.
- Full system performance is not yet available for a few seconds after you start the vehicle or drive off.

The system may not react correctly in the following situations:

- In complex traffic situations, objects may not always be clearly detected.
- Pedestrians or vehicles move quickly into the detection range of the sensors.
- Pedestrians are obscured by other objects.
- Narrow-radius bends may hamper the system's ability to react correctly.

Setting Active Brake Assist

Requirements:

- The vehicle is switched on.

Multimedia system:

The following settings are available:

- **Early**
- **Medium**
- **Late**
- **Off**

It is recommended that Active Brake Assist is always left activated.

Select a setting.

The last active setting is selected automatically every time the vehicle is started.

Exception: if the last setting was **Off**, the **Medium** setting will be automatically activated the next time the vehicle is started.

Deactivating Active Brake Assist

It is recommended that Active Brake Assist is always left activated.

Select **Off**.

The distance warning function and autonomous braking function are deactivated.

When the vehicle is next started, the **Medium** setting is automatically activated.

If Active Brake Assist is deactivated, the symbol appears in the status bar of the instrument cluster.

Cruise control

Function of cruise control

To maintain a previously stored speed, cruise control accelerates and brakes the vehicle independently.

For example, the stored speed will not be deleted if you accelerate to overtake. If you remove your foot from the accelerator pedal after overtaking, cruise control will resume speed regulation back to the stored speed.

Cruise control is operated using the corresponding steering wheel buttons. You can set any speed from 12 mph (rounded) (20 km/h).

If you fail to adapt your driving style, cruise control can neither reduce the risk of an accident nor override the laws of physics. It cannot take into account road, weather or traffic conditions. Cruise control serves solely as an aid. You are responsible for maintaining a safe distance to the vehicle in front, vehicle speed, braking in good time and for staying in your lane.

The status of cruise control and the stored speed are shown on the instrument cluster.

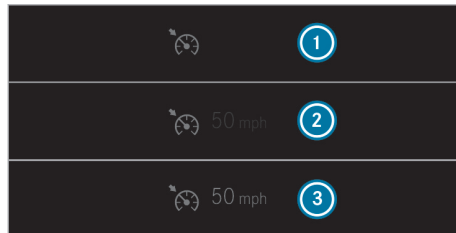

Instrument cluster display (color display)

- 1 Cruise control is selected.
- 2 Set speed gray: speed is stored, cruise control is deactivated.
- 3 Set speed green: speed is stored, cruise control is activated.

System limits

Cruise control may be unable to maintain the stored speed on uphill gradients. The stored speed will be resumed when the gradient levels out.

On long and steep downhill gradients, you must shift down to a lower gear in good time. This is particularly important when you are driving a laden vehicle. By doing so, you will make use of the engine's braking effect. This will take some of the strain off the brake system and prevent the brakes from overheating and wearing too quickly.

Do not use cruise control in the following situations:

- In the event of frequent changes in speed, e.g. in heavy traffic or on winding roads.
- On slick or slippery roads. The wheels on the drive axle may lose traction upon acceleration, causing the vehicle to begin skidding.
- When visibility is poor

Operating cruise control

⚠ WARNING Risk of accident due to stored speed

If you call up the stored speed and this is lower than your current speed, the vehicle decelerates.

- ▶ Take into account the traffic situation before calling up the stored speed.

Requirements:

- Cruise control is selected.
- ESP® must be activated but not intervening.
- The vehicle speed is at least 15 mph (20 km/h).
- The transmission is in position **D**.

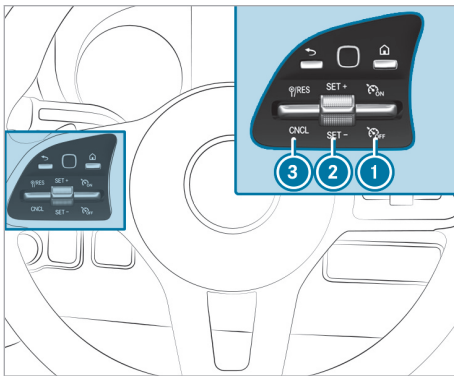

- ▶ **To activate cruise control:** push rocker switch **1** up.
- ▶ Remove your foot from the accelerator pedal. The current speed will be stored and maintained by the vehicle.
- ▶ Push rocker switch **1** up.
- ▶ **To increase/reduce speed:** push rocker switch **2** up or down. The stored speed is increased or reduced by 1 mph (1 km/h).

or

- ▶ Press rocker switch **2** up or down and hold it there. The stored speed will be increased or reduced in 1 mph (1 km/h) increments.

or

- ▶ Push rocker switch **2** beyond the pressure point. The stored speed will be increased or reduced by 5 mph (10 km/h).

or

- ▶ Push rocker switch **2** beyond the pressure point and hold it there. The stored speed will be increased or reduced in 5 mph (10 km/h) increments.

or

- ▶ Accelerate the vehicle to the desired speed.
- ▶ Push rocker switch **2** up.

If Traffic Sign Assist detects a maximum permissible speed traffic sign with the cruise control active, and this appears on the instrument cluster display:

- ▶ **To adopt the detected speed:** push rocker switch **3** up. The maximum permissible speed shown by the traffic sign will be stored, and the vehicle will maintain this speed.
- ▶ **To deactivate cruise control:** push rocker switch **3** (CNCL) down.

If cruise control is deactivated, reactivate as follows:

- The current speed is stored with rocker switch **2** **SET+** or **SET-** and will then be maintained by the vehicle.
- Rocker switch **3** (RES) calls up the last speed stored, and the vehicle will then maintain this speed

- i** If you brake, deactivate ESP®, or if ESP® intervenes, cruise control will be deactivated. When you switch off the vehicle, the last speed stored will be deleted.

DSR (Downhill Speed Regulation)

Notes on DSR

If you fail to adapt your driving style or you are inattentive, DSR can neither reduce the risk of accident nor override the laws of physics. DSR cannot take road, weather and traffic conditions into account. DSR is only an aid. You are responsible especially for a safe distance to the vehicle in

front, for vehicle speed and for braking in good time.

DSR supports you when driving downhill. DSR maintains a set speed for you on downhill gradients by applying the brakes as required. Maintaining the speed is dependent on the road surface conditions and the downhill gradient and cannot therefore be guaranteed in all situations.

You can set the speed depending on the gear range to between 2 mph (4 km/h) and 11 mph (18 km/h) using the brake and accelerator pedals or the rocker switch on the steering wheel.

DSR automatically controls in the following situations:

- If the vehicle is stationary, or its speed is less than 2 mph (4 km/h), the speed is set to 2 mph (4 km/h) or it is set to the minimum speed for the respective gear range.
- If you drive faster than 11 mph (18 km/h) off-road, DSR switches to standby mode. DSR remains activated, but does not brake automatically.
- If you drive downhill slower than 11 mph (18 km/h), DSR sets the speed to the previously set speed.
- If you drive faster than 28 mph (45 km/h), DSR switches off automatically.

■ Activating/deactivating DSR

Activating DSR

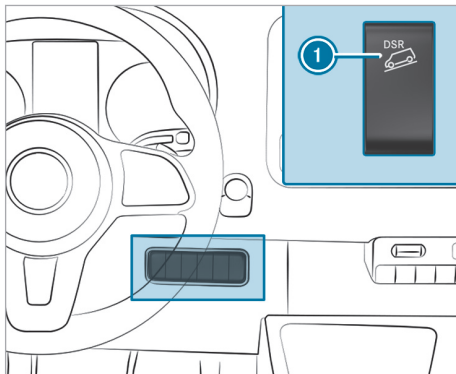

You can activate DSR when the vehicle is stationary or moving.

- ▶ Press the upper section of switch ①.

- ▶ Brake or accelerate the vehicle to the desired speed between 2 mph (4 km/h) and 11 mph (18 km/h).
- ▶ Release the brake or accelerator pedal. The current speed will be stored. When stationary, 2 mph (4 km/h) or the minimum possible speed in the respective gear range will be stored. DSR will maintain the stored speed on the downhill gradient and will brake automatically.

When DSR is activated and the vehicle pulls away, accelerates or brakes on an incline: the speed set corresponds to the speed at which the accelerator or brake pedal is released or the rocker switch on the steering wheel is pressed during DSR regulation. This is the case only if you are driving no faster than 11 mph (18 km/h).

DSR status display in the on-board computer

- **DSR is activated:**
 - DSR and the set speed appear in the status area of the on-board computer.
- **DSR is activated, but is not intervening:**
 - You are driving at a speed between 11 mph (18 km/h) and 28 mph (45 km/h).
 - DSR and the speed 11 mph (18 km/h) appear in the status area of the on-board computer.
 - DSR is in standby mode.
- **DSR is inactive:**
 - As soon as you exceed a speed of 28 mph (45 km/h).
 - DSR appears in the status area of the on-board computer. In addition, the DSR Off message appears.
 - DSR --- appears in the status area of the on-board computer.

Setting the speed while driving downhill

You can set the speed to between 2 mph (4 km/h) and 11 mph (18 km/h) using the brake and accelerator pedals or the rocker switch on the steering wheel.

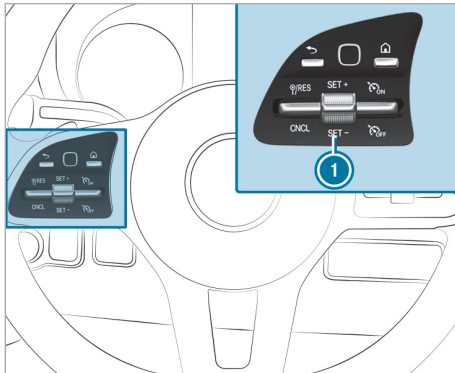

- ▶ Brake or accelerate the vehicle to the desired speed on the downhill gradient.
- ▶ Release the brake or accelerator pedal. The current speed will be stored.

or

- ▶ Press rocker switch ① up or down during a DSR regulation. The last saved speed will be increased or reduced.
- ▶ Release rocker switch ①. The current speed will be stored.

or

- ▶ Press rocker switch ① up or down until the desired speed is reached.
- ▶ Release rocker switch ①. The current speed will be stored.

① It may be a moment before the vehicle starts to brake to the set speed. Take this delay into account when setting the speed with rocker switch ①.

Deactivating DSR

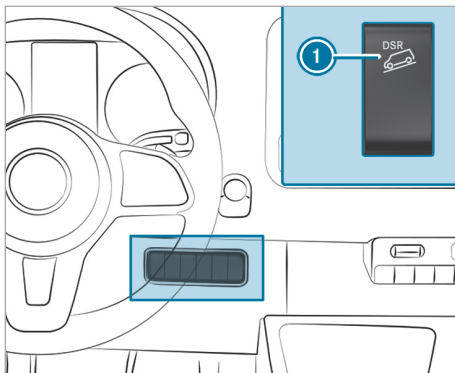

- ▶ Press the upper section of switch ①.

or

- ▶ Accelerate and drive faster than 28 mph (45 km/h).

DSR will deactivate automatically in the following situations:

- As soon as you exceed a speed of 28 mph (45 km/h).
- ESP® or ABS is malfunctioning.

Active Distance Assist DISTRONIC

Function of Active Distance Assist DISTRONIC

Active Distance Assist DISTRONIC maintains the set speed on free-flowing roads. If vehicles ahead are detected, the set distance will be maintained, until the vehicle comes to a halt if necessary. The vehicle will accelerate or brake, depending on the distance to the vehicle in front and the set speed. You can set and save the speed and distance to the vehicle in front using the steering wheel. The speed can be set in a range between 12 mph (20 km/h) and 99 mph (160 km/h) or between 12 mph (20 km/h) and the vehicle's maximum design speed.

Other features of Active Distance Assist DISTRONIC:

- Depending on the preselected distance, DISTRONIC will intervene either dynamically (short distance) or to save fuel (long distance).
- Depending on the vehicle mass detected, the dynamics of the DISTRONIC intervention will be reduced.
- If the turn signal indicator is activated to change to the overtaking lane, rapid acceleration to the stored speed will be initiated.

Active Distance Assist DISTRONIC is provided solely as an aid. The driver is responsible for the distance to the vehicle in front, for vehicle speed and for braking in good time.

System limits

The system may be impaired or inoperative in the following situations, for example:

- If the radar sensors are malfunctioning due to snow, rain, fog, heavy spray, glare, direct sunlight or extreme changes in ambient light.
- The radar sensors may malfunction in parking garages or on roads with steep gradients.
- If the radar sensors are dirty or obscured.

- On slippery roads, braking or accelerating may cause the wheels to lose traction and the vehicle could then skid.
- Stationary objects will not be detected if they have not previously been detected as moving.
- On bends, target vehicles may be lost or not recognized correctly. As a result, distance to a target vehicle will no longer be regulated and unintentional acceleration may occur.

Do not use Active Distance Assist DISTRONIC in these situations.

⚠ WARNING Risk of accident from acceleration or braking by Active Distance Assist DISTRONIC

Active Distance Assist DISTRONIC may accelerate or brake in the following cases, for example:

- If the vehicle pulls away using Active Distance Assist DISTRONIC.
- If the stored speed is called up and is considerably faster or slower than the currently driven speed.
- If Active Distance Assist DISTRONIC no longer detects a vehicle in front or does not react to relevant objects.

- ▶ Always carefully observe the traffic conditions and be ready to brake at all times.
- ▶ Take into account the traffic situation before calling up the stored speed.

⚠ WARNING Risk of accident due to insufficient deceleration by Active Distance Assist DISTRONIC

Active Distance Assist DISTRONIC brakes your vehicle with up to 50% of the possible deceleration. If this deceleration is not sufficient, Active Distance Assist DISTRONIC alerts you with a visual and acoustic warning.

- ▶ Adjust your speed and maintain a suitable distance from the vehicle in front.
- ▶ Brake the vehicle yourself and/or take evasive action.

⚠ WARNING Risk of accident if detection function of Active Distance Assist DISTRONIC is impaired

Active Distance Assist DISTRONIC does not react or has a limited reaction:

- when driving on a different lane or when changing lanes
- to pedestrians, animals, bicycles or stationary vehicles, or unexpected obstacles
- to complex traffic conditions
- to oncoming vehicles and crossing traffic

As a result, Active Distance Assist DISTRONIC may neither give warnings nor intervene in such situations.

- ▶ Always observe the traffic conditions carefully and react accordingly.

⚠ WARNING Risk of accident due to adjustment of speed by Active Speed Limit Assist.

The speed adopted by the Active Speed Limit Assist may be too high or incorrect in individual cases:

- At limit speeds below 12 mph (20 km/h)
- In wet or foggy conditions

- ▶ Ensure that the speed being driven always complies with the traffic laws.
- ▶ Adjust the speed being driven to the current traffic and weather conditions.

Active Distance Assist DISTRONIC may not detect narrow vehicles driving in front, e.g. motorcycles or vehicles not traveling in line with your vehicle.

■ Operating Active Distance Assist DISTRONIC

Requirements

- The vehicle has been started.
- The parking brake has been released.
- ESP® is activated and is not intervening.
- The transmission is in position **[D]**.
- The driver's door and the front passenger door are closed.
- The seat occupancy recognition on the driver's seat has detected that the driver has fastened the seat belt.
- The radar sensor system check has been successfully completed.

Activating Active Distance Assist DISTRONIC

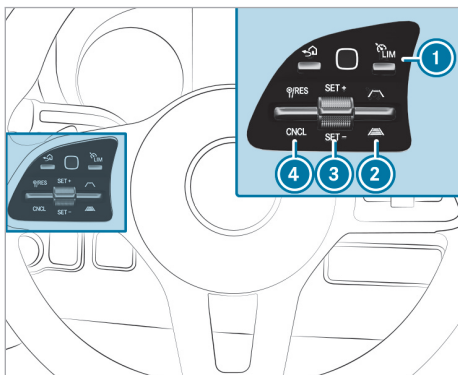

- ▶ Press button ①.

- ▶ **To activate with no stored speed:** push rocker switch ③ up **SET+** or down **SET-**.
The current speed will be stored and maintained by the vehicle.

or

- ▶ **To activate with a stored speed:** push rocker switch ④ up **RES**.

① If rocker switch ④ is pressed up twice, Active Distance Assist DISTRONIC will be activated with the speed restriction displayed on the instrument cluster.

Adopting the displayed speed restriction when Active Distance Assist DISTRONIC is active

- ▶ Push rocker switch ④ up **RES**.
The speed restriction displayed on the instrument cluster will be adopted as the stored speed. The vehicle will adapt its speed to that of the vehicle in front, but only up to the stored speed.

Pulling away again with Active Distance Assist DISTRONIC

- ▶ Remove your foot from the brake pedal.
- ▶ Push rocker switch ④ up **RES**.

or

- ▶ Depress the accelerator pedal briefly and firmly.
The Active Distance Assist DISTRONIC functions will continue to operate normally.

Deactivating Active Distance Assist DISTRONIC

⚠ WARNING Risk of an accident due to Active Distance Assist DISTRONIC being active when you leave the driver's seat

If you leave the driver's seat while the vehicle is being braked by Active Distance Assist DISTRONIC only, the vehicle can roll away.

▶ Always deactivate Active Distance Assist DISTRONIC and secure the vehicle to prevent it from rolling away before you leave the driver's seat.

- ▶ Push rocker switch ④ down **CNCL**.
- ▶ Depress the brake pedal.

Active Distance Assist DISTRONIC will automatically be deactivated in the following circumstances:

- The driver's seat belt buckle is unfastened and the vehicle is traveling at a speed of less than 2 mph (3 km/h).
- The driver's seat is not occupied.
- The transmission is not in position **D**.
- The parking brake is applied.
- The driver's door or front passenger door is open.
- There is an internal error.

In addition to the deactivation of Active Distance Assist DISTRONIC, transmission position **P** will automatically be engaged in the event of any of these situations arising, or if the vehicle is traveling very slowly.

Increasing and reducing the speed

- ▶ Push rocker switch ③ up **SET+** or down **SET-** as far as the point of resistance.
The stored speed will be increased or reduced by 1 mph (1 km/h).

or

- ▶ Push rocker switch ③ up **SET+** / down **SET-** as far as the point of resistance and hold.
The stored speed will be increased or reduced in 1 mph (1 km/h) increments.





or

- ▶ Push rocker switch ③ beyond the point of resistance.
The stored speed will be increased or reduced by 5 mph (10 km/h).

or

- ▶ Push rocker switch  beyond the point of resistance and hold. The stored speed will be increased or reduced in 5 mph (10 km/h) increments.

Increasing and decreasing the specified distance from the vehicle in front

- ▶ **To increase the specified distance:** push rocker switch  down ().
- ▶ **To reduce the specified distance:** push rocker switch  up (.

Information on Hill Start Assist

Hill Start Assist holds the vehicle for a short time when pulling away on a hill under the following conditions:

- **Vehicles with automatic transmission:** the transmission is in position **D** or **R**.
- The parking brake has been released.

This gives you enough time to move your foot from the brake pedal to the accelerator pedal and depress it before the vehicle begins to roll.

 **WARNING** Risk of accident and injury due to the vehicle rolling away

After a short time, Hill Start Assist no longer holds the vehicle.

- ▶ Swiftly move your foot from the brake pedal to the accelerator pedal. Do not leave the vehicle when it is being held by Hill Start Assist.

HOLD function

Notes on the HOLD function

Requirement

The seat occupancy recognition on the driver's seat has detected that the driver has fastened the seat belt.

Function

The HOLD function holds the vehicle at a standstill without requiring you to depress the brake pedal, e.g. when you are pulling away on steep slopes or waiting in traffic. When you depress the accelerator pedal to pull away, the braking effect will be canceled and the HOLD function deactivated.

The HOLD function is only an aid. The responsibility for the vehicle safely standing still remains with the driver.

System limits

The HOLD function is intended only to provide assistance when you are driving and is not a sufficient means of safeguarding the vehicle against rolling away when stationary.

The incline cannot be greater than 30%.

Activating/deactivating the HOLD function

Requirements:

- The vehicle is stationary.
- The vehicle has been started or has been automatically switched off by the ECO start/stop function.
- The driver is seated and their seat belt is fastened.
- The electric parking brake has been released.
- **Vehicles with automatic transmission:** the selector lever is in position **D**, **R** or **N**.

Activating the HOLD function

 **WARNING** Risk of an accident due to the HOLD function being active when you leave the vehicle

If the vehicle is only braked with the HOLD function it could, in the following situations, roll away:

- If there is a malfunction in the system or in the power supply.
- If the HOLD function is deactivated by depressing the accelerator pedal or brake pedal, e.g. by a vehicle occupant.

- ▶ Always secure the vehicle against rolling away before you leave it.

 **NOTE** Damage to the vehicle due to automatic braking

When the following functions are activated, the vehicle brakes automatically in certain situations:

- Active Brake Assist
- Active Distance Assist DISTRONIC
- HOLD function

To avoid damage to the vehicle, deactivate these systems in the following or similar situations:

- ▶ When towing
- ▶ In a car wash

- ▶ Make sure that the activation conditions are met.
- ▶ Depress the brake pedal until the **HOLD** display appears on the instrument cluster display. The HOLD function is activated. You can release the brake pedal.
- ⓘ If depressing the brake pedal the first time does not activate the HOLD function, wait briefly and then try again.

Deactivating the HOLD function

- ▶ **Vehicles with automatic transmission:** depress the accelerator pedal with the automatic transmission in position **D** or **R**.
- ▶ Depress the brake pedal again with sufficient pressure until the **HOLD** display on the instrument cluster display goes out.
- ⓘ **Vehicles with automatic transmission:** your vehicle's automatic transmission will shift to **P** after a while. This relieves the load on the service brake.

When the HOLD function is activated, the automatic transmission will automatically shift to **P** in the following situations:

- The driver leaves the driver's seat.
- The driver's door is opened.
- The vehicle is switched off without the ECO start/stop function.

Parking Assist PARKTRONIC

Function of Parking Assist PARKTRONIC

Parking Assist PARKTRONIC is an electronic parking assistance system with ultrasound. It monitors the area around your vehicle using six sensors in the front bumper and six sensors in the rear bumper. Parking Assist PARKTRONIC indicates visually and audibly the distance between your vehicle and an obstacle.

Special equipment without rear sensors is available for vehicles with rear attachments or selected open vehicle model designations. Here, the six sensors in the rear bumper are omitted. No distances to an obstacle are displayed for the rear and side areas, and no visual warnings or warning tones are issued.

Parking Assist PARKTRONIC serves solely as an aid. It is not a substitute for your attention to the surroundings. The responsibility for safe maneuvering and parking remains with you. Ensure that there are no persons, animals or objects etc. in

the maneuvering area while maneuvering and parking in/exiting parking spaces.

In the standard setting, an intermittent warning tone will sound from a distance of approximately 1.3 ft (0.4 m) to an obstacle. A continuous warning tone will sound from a distance of approximately 1.0 ft (0.3 m). You can set the warning tone in the multimedia system so that it will sound earlier at a greater distance of approximately 3.3 ft (1 m) (→ page 157).

Parking Assist PARKTRONIC display in the multimedia system

If the Parking Assist PARKTRONIC display is not active and an obstacle is detected in the path of the vehicle, a pop-up window for Parking Assist PARKTRONIC will appear at speeds of up to approximately 6 mph (10 km/h).

System limits

Parking Assist PARKTRONIC does not necessarily take into account the following obstacles:

- Obstacles below the detection range, e.g. persons, animals or objects.
- Obstacles above the detection range, e.g. overhanging loads, overhangs or loading ramps of trucks.

The sensors must be free of dirt, ice and slush. Otherwise, they may not function correctly. Clean the sensors regularly, taking care not to scratch or damage them.

Vehicles with trailer hitch: Parking Assist PARKTRONIC is deactivated for the rear zone when you establish an electrical connection between your vehicle and a trailer.

Deactivating/activating Parking Assist PARKTRONIC

! **NOTE** Vehicle damage during parking or maneuvering due to objects at close range

Parking Assist PARKTRONIC may not detect certain objects close to the vehicle.

- ▶ When parking or maneuvering, look out in particular for objects that are underneath or above the sensors, e.g. flower pots or drawbars. Otherwise, the vehicle or other objects could be damaged.

Multimedia system:

→ [Home] ▶ Settings ▶ Quick Access

- ▶ Select **PARKTRONIC On**.
The function is activated or deactivated depending on the previous setting.

ⓘ Parking Assist PARKTRONIC is automatically activated upon engine start.

Setting the warning tones of Parking Assist PARKTRONIC

Multimedia system:

→ Settings ▶ Assistance
▶ Camera & Parking ▶ Set Warning Tones

Adjusting the volume of the warning tones

- ▶ Select **Warning Tone Volume**.
- ▶ Adjust the value.

Adjusting the pitch of the warning tones

- ▶ Select **Warning Tone Pitch**.
- ▶ Adjust the value.

Specifying the starting point for the warning tones

You can specify whether the Parking Assist PARKTRONIC warning tones should commence when the vehicle is further away from an obstacle.

- ▶ Select **Warn Early All Around**.
- ▶ Activate or deactivate the function.

Activating or deactivating audio fadeout

You can specify whether the volume of a media source in the multimedia system should be reduced during a Parking Assist PARKTRONIC warning tone.

- ▶ Select **Audio Fadeout During Warning Tones**.
- ▶ Activate or deactivate the function.

Rear view camera

Function of the rear-view camera

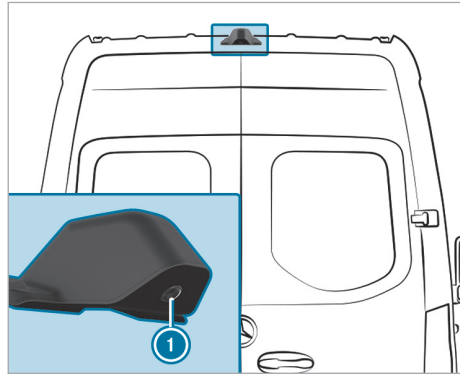

If you have activated the function in the multimedia system, the image from rear view camera ① will appear in the multimedia system when reverse gear is selected. Dynamic guide lines show the path the vehicle will take for the current steering movement. This will help you to orient yourself and to avoid obstacles when backing up.

The image from rear-view camera ① will appear in the multimedia system when the following conditions are fulfilled:

- The vehicle is switched on.
- Reverse gear has not been engaged.
- The rear-end doors are opened.

This allows the area behind the vehicle to be monitored.

When the rear-end doors are closed, the image from the rear-view camera will be switched off after approximately ten seconds.

The rear-view camera is only an aid. It is not a substitute for you paying attention to the surroundings. You are always responsible for safe maneuvering and parking. Make sure that there are no persons, animals or objects etc. in the maneuvering area while maneuvering and parking in parking spaces.

The rear-view camera may show a distorted view of obstacles or show them incorrectly or not at all. The rear-view camera cannot show all objects that are very near to or under the rear bumper. It will not warn you of a collision, people or objects.

You can select from the following views:

- Normal view
- Wide-angle view
- Trailer view

The area behind the vehicle will be displayed as a mirror image, as in the inside rear-view mirror.

System limits

The rear-view camera will not function or will function only partially in the following situations:

- if there is heavy rain, snow or fog
- if the ambient light is poor, e.g. at night
- if the area is illuminated with fluorescent lighting (the display may flicker)
- if the temperature changes very quickly, such as if you drive out of the cold into a heated garage in the winter
- if the ambient temperature is very high
- if the camera lens is obscured, dirty or fogged up. Observe the notes on cleaning the rear-view camera (→ page 222)
- if the camera or rear of your vehicle is damaged. In this event, have the camera, its position and its setting checked at a qualified specialist workshop.

The field of vision and other functions of the rear-view camera may be restricted due to additional accessories on the rear of the vehicle (e.g. a loading tailgate).

- ⓘ The display contrast may be impaired due to incidental sunlight or other light sources. In this case, pay particular attention.
- ⓘ Have the display repaired or replaced if, for example, pixel errors considerably restrict its use.
- ⓘ Objects that are not at ground level will appear further away than they actually are. This includes, for example:
 - the bumper of a vehicle parked behind
 - the drawbar of a trailer
 - the ball neck of a trailer hitch
 - the tail end of a truck
 - slanted posts

Use the guide lines of the camera image only for orientation. Do not travel further than the lowest horizontal guide line when approaching

objects. You may otherwise damage your vehicle and/or the object.

Vehicles without Parking Assist PARKTRONIC

The following camera views are available in the multimedia system:

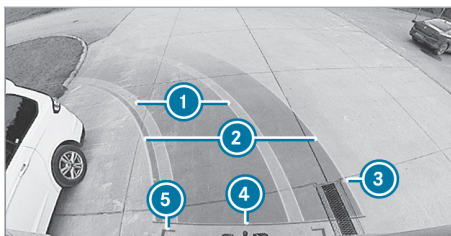

Normal view

- ① Yellow path marking the course the tires will take at the current steering position (dynamic)
- ② Yellow guide line, vehicle width (driven surface) depending on the current steering angle (dynamic)
- ③ Marking at a distance of approximately 3.3 ft (1.0 m) (the rear-end doors can still be opened completely)
- ④ Red guide line at a distance of approximately 1.0 ft (0.3 m) from the rear area
- ⑤ Red guide lines at a distance of approximately 8 in (0.2 m) from the rear area, vehicle width including exterior mirrors



Wide-angle view

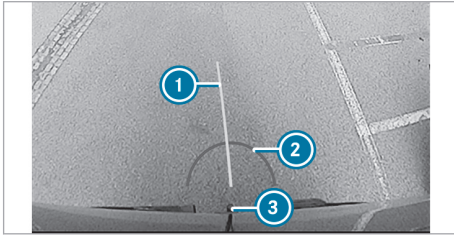

Trailer view (if hitch is fitted)

- ① Yellow guide line, locating aid
- ② Red guide line at a distance of approximately 1.0 ft (0.3 m) to the ball head of the trailer hitch
- ③ Ball head of the trailer hitch

Vehicles with Parking Assist PARKTRONIC

The following camera views are available in the multimedia system:

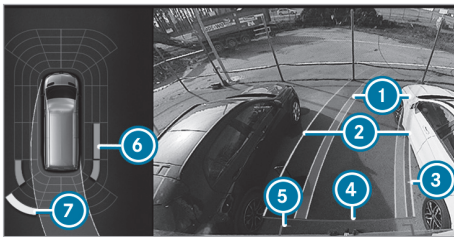

Normal view

- ① Yellow path marking the course the tires will take at the current steering position (dynamic)
- ② Yellow guide line, vehicle width (driven surface) depending on the current steering angle (dynamic)
- ③ Marking at a distance of approximately 3.3 ft (1.0 m) (the rear-end doors can still be opened completely)
- ④ Red guide line at a distance of approximately 1.0 ft (0.3 m) from the rear area
- ⑤ Red guide lines at a distance of approximately 8 in. (0.2 m) from the rear area, vehicle width including exterior mirrors
- ⑥ Orange warning display of Parking Assist PARKTRONIC: obstacles are a medium distance away (between approximately 1.3 ft (0.4 m) and 2.0 ft (0.6 m))
- ⑦ Yellow warning display of Parking Assist PARKTRONIC: obstacles at a distance between approximately 2.0 ft (0.6 m) and 3.3 ft (1.0 m)

① If the distance to the obstacle is less than approximately 1.3 ft (0.4 m), the warning display of Parking Assist PARKTRONIC will be red.

① If the entire system fails, the inner segments of the warning display will be shown in red.

If the system fails at the rear, the segment display will change in the following ways:

- the rear segments will be shown in red when you are backing up
- the rear segments will be hidden when you are driving forwards

If Parking Assist PARKTRONIC is deactivated, the warning display will fade out.



Wide-angle view

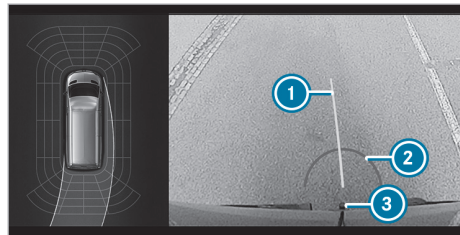

Trailer view (if hitch is fitted)

- ① Yellow guide line, locating aid
- ② Red guide line at a distance of approximately 1.0 ft (0.3 m) to the ball head of the trailer hitch
- ③ Ball head of the trailer hitch

360° camera

Function of the 360° camera

The 360° camera is a system comprising four cameras. The cameras cover the immediate vehicle surroundings. The system will assist you, for example, with parking or at exits with reduced visibility.

The 360° camera serves solely as an aid. It is not a substitute for you having to pay attention to your surroundings. You are always responsible for safe maneuvering and parking. Ensure that there are no persons, animals or objects etc. in the maneuvering area while you are maneuvering and parking.

The system evaluates images from the following cameras:

- Rear-view camera
- Front camera
- Two side cameras in the outside mirrors

Views of the 360° camera

- i** With the special equipment without rear sensors, only the front segments are shown in the left-hand image area; see "Top view, without rear sensors" example image.

Only warnings for the front area will be issued.

You can select from different views:

Top view



Top view, with rear sensors

- ① Yellow lanes mark the course the tires will take with the current steering movement (dynamic)
- ② Yellow guide line, vehicle width (driven surface) depending on the current steering movement (dynamic)
- ③ Marking at a distance of approximately 3.3 ft (1.0 m) (the rear doors can still be opened completely)
- ④ Red guide line at a distance of approximately 1.0 in (0.3 m) from the rear area
- ⑤ Red guide lines at a distance of approximately 8 in (0.2 m) from the rear area; vehicle width including outside mirrors
- ⑥ Red warning display of Parking Assist PARKTRONIC: obstacles at a distance of approximately 1.3 ft (0.4 m) or less

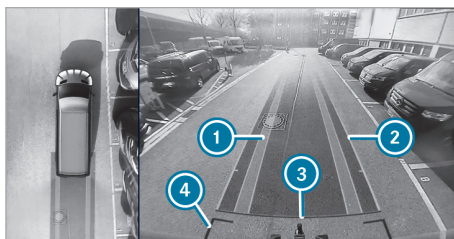

Top view, without rear sensors

- ① Yellow lanes mark the course the tires will take with the current steering movement (dynamic)
- ② Yellow guide line, vehicle width (driven surface) depending on the current steering movement (dynamic)
- ③ Red guide line at a distance of approximately 1.0 in (0.3 m) from the rear area
- ④ Red guide lines at a distance of approximately 8 in (0.2 m) from the rear area; vehicle width including outside mirrors

When Parking Assist PARKTRONIC is operational and no object is detected, the segments of the warning display will be shown in gray.

- i** If the entire system fails, the segments of the warning display will be shown in red.

If the system fails at the rear, the segment display will change as follows:

- The rear segments will be highlighted in red when you are backing up.
- The rear segments will be hidden when you are moving forward

If Parking Assist PARKTRONIC is deactivated, the warning display will fade out.

Guide lines

- i** The guide lines on the multimedia system display show the distances to your vehicle. The distances apply only to road level. In trailer mode, the guide lines will be shown at the level of the trailer hitch.

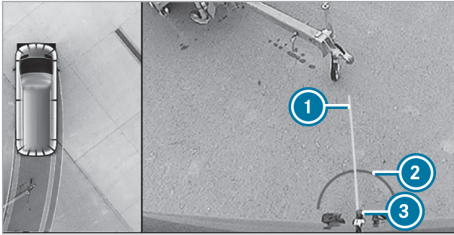
View of trailer (if trailer hitch is installed)

View of trailer (if trailer hitch is installed), with rear sensors

- ① Yellow guide line, locating aid
- ② Red guide line at a distance of approximately 1.0 ft (0.3 m) from the ball head of the trailer hitch
- ③ Ball head of the trailer hitch

Side view of the outside mirror cameras

The sides of the vehicle can be seen in this view.

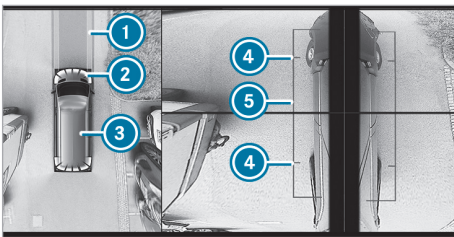

Side view, with rear sensors

- ① Path indicating the route the vehicle will take with the steering wheel in its current position
- ② Yellow warning display of Parking Assist PARKTRONIC: obstacles at a distance of approximately 3.3 ft (1.0 m) or less
- ③ Your vehicle from above
- ④ Marker of the wheel contact points
- ⑤ Guide line of external vehicle dimensions with outside mirrors extended

If the distance to the object decreases, the color of warning display ② will change.

System failure

If the system is not yet operational, the following display will appear in the multimedia system:

**System limits**

The 360° camera will not function, or will function only partially in the following situations:

- If the front doors are open.
- If the outside mirrors are retracted.
- If there is heavy rain, snow or fog.
- If the ambient light is poor, e.g. at night.
- If the area is illuminated with fluorescent lighting (the display may flicker).
- If the temperature changes very quickly; for example, if you drive out of the cold into a heated garage during the winter months.
- If the ambient temperature is very high.
- If the camera lens is obstructed, dirty or fogged up.
- If cameras, or vehicle components in which the cameras are installed, are damaged. In this event, have the cameras, their positions and their settings checked at a qualified specialist workshop.

Do not use the 360° camera in any of these circumstances. Otherwise, you could injure others or collide with objects when parking the vehicle.

On vehicles with height-adjustable suspension, or if the vehicle is carrying a heavy load, deviations from the standard height may result in inaccuracies in the guide lines and in the display of the generated images, depending on technical conditions.

The field of vision and other functions of the camera system may be restricted due to additional attachments on the vehicle (e.g. loading tailgate).

i The display contrast may be impaired by sudden, incidental sunlight or other light sources, e.g. when you are driving out of a garage. Particular attention should be afforded in these conditions.

i Have the display repaired or replaced if, for example, its use is considerably restricted due to pixel errors.

The image from the 360° camera will appear automatically in the multimedia system when:

- The vehicle is switched on.
- The rear doors are opened.

This allows the area behind the vehicle to be monitored.

When the rear doors are closed, the image from the rear-view camera will be switched off after approximately ten seconds.

See the notes on cleaning the 360° camera (→ page 222).

Selecting a view for the 360° camera

Requirements:

- The **Auto. Rear View Cam.** function is activated in the multimedia system (→ page 162).

- ▶ Engage reverse gear.
- ▶ Select the desired view in the multimedia system.

Activating/deactivating automatic operation of the rear-view camera

The rear-view camera is only an aid. It is not a substitute for your attention to your surroundings. The responsibility for safe maneuvering and parking remains with you. Make sure that no persons, animals or objects etc. are in the maneuvering range. Pay attention to your surroundings and be ready to brake at all times.

Multimedia system:

- ▶  ▶ **Settings** ▶ **Assistance**
- ▶ **Camera & Parking**
- ▶ Activate or deactivate **Auto. Rear View Cam.**

Activating/deactivating maneuvering assistance

Multimedia system:

- ▶  ▶ **Settings** ▶ **Assistance**
- ▶ **Camera & Parking**

- ▶ Activate or deactivate **Maneuvering Assistance**.

- ① If maneuvering assistance is switched on and rear sensors are present, the following functions are active:
 - Drive Away Assist (→ page 166)
 - Rear Cross Traffic Alert (→ page 167)
- ① If the maneuvering assistant is activated and there are no rear sensors, Drive Away Assist is active but only works when driving forwards (→ page 166).

ATTENTION ASSIST

Function of ATTENTION ASSIST

ATTENTION ASSIST can assist you on long, monotonous journeys, e.g. on highways and trunk roads. If ATTENTION ASSIST detects indicators of fatigue or increasing lapses in concentration on the driver's part, it suggests taking a break.

ATTENTION ASSIST serves solely as an aid. It cannot always promptly detect fatigue or lapses in concentration. The system is not a substitute for a well-rested and attentive driver. On long journeys, take regular, timely breaks to allow for adequate recovery.

You can choose between two settings:

- **Standard:** normal system sensitivity.
- **Sensitive:** higher system sensitivity. The driver is warned at an earlier stage, and the attention level detected by the system is adapted accordingly.

If fatigue or increased lapses in concentration are detected, the **Attention Assist: Take a Break!** warning appears in the instrument cluster. You can acknowledge the message and take a break if necessary. If you do not take a break and ATTENTION ASSIST continues to detect increasing lapses in concentration, you will be warned again after a minimum of 15 minutes.

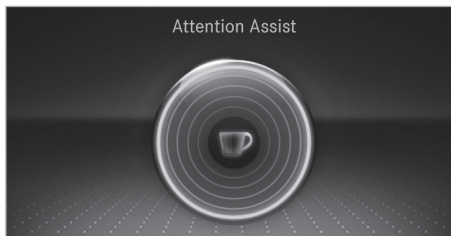

Instrument cluster with display (color)

You can have the following status information for ATTENTION ASSIST displayed in the Assistance menu of the on-board computer:

- journey time since the last break
- attention level determined by ATTENTION ASSIST:
 - The fuller the circle, the higher the detected attention level
 - The circle in the center of the display empties from the outside inwards as attentiveness decreases



Instrument cluster with display (black and white)

You can have the following status information for ATTENTION ASSIST displayed in the Assistance menu of the on-board computer:

- journey time since the last break
- attention level determined by ATTENTION ASSIST:
 - The fuller the bar, the higher the detected attention level
 - The bar empties as attentiveness decreases

If the ATTENTION ASSIST cannot calculate the attention level and cannot issue a warning, the **Attention Level** message appears.

If a warning is displayed in the instrument cluster, the multimedia system offers to search for a rest area. You can select a rest area and start navigation to this rest area. This function can be activated and deactivated in the multimedia system.

If ATTENTION ASSIST is deactivated, the  symbol appears in the assistance graphic in the instrument cluster when the vehicle is running. ATTENTION ASSIST is activated automatically when the vehicle is restarted. The last selected sensitivity level remains stored.

System limits

ATTENTION ASSIST is active in the 37 mph (60 km/h) to 124 mph (200 km/h) speed range.

The functionality of ATTENTION ASSIST is restricted, and warnings may be delayed or not issued at all in the following situations:

- The journey is less than approximately 30 minutes
- Road conditions are poor (uneven road surface or potholes)
- The vehicle is subjected to a strong crosswind
- You have a sporty driving style (high cornering speeds or high rates of acceleration)

- The time is set incorrectly
- You change lanes and vary your speed frequently in active driving situations

The ATTENTION ASSIST drowsiness or attentiveness assessment is deleted and restarted when continuing the journey in the following situations:

- You switch off the vehicle.
- If you unfasten your seat belt and open the driver's door (e.g. to change drivers or take a break).

Setting ATTENTION ASSIST

Multimedia system:

-  ► Settings ► Assistance
- Attention Assist

Setting options

- Select **Standard**, **Sensitive** or **Off**.

Suggesting a rest area

- Select **Suggest Rest Area**.
- Activate or deactivate the function. If ATTENTION ASSIST detects fatigue or an increasing lack of attention, it suggests a nearby rest area.
- Select a suggested rest area. You are guided to the selected rest area.

Traffic Sign Assist

Function of Traffic Sign Assist

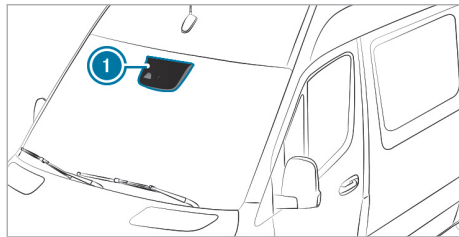

Traffic Sign Assist detects traffic signs with multi-function camera . It assists you by displaying detected speed limits and overtaking restrictions on the instrument cluster.

Important information from other systems can cause traffic signs to be hidden for a short time.

Traffic Sign Assist also uses stored map data. The display is thus updated without a traffic sign having been detected in the following situations:

- When the vehicle changes roads, e.g. a free-way on- or off-ramp
- When a village or city boundary stored in the digital map is passed

The system displays the traffic signs valid for the vehicle model registration. A distinction is made between the valid traffic signs for a permissible gross mass (GVWR) ≤ 7716 lbs (3.5 t), >7716 lbs (3.5 t) and camper van.

The camera also detects traffic signs with a restriction indicated by an additional sign (e.g. when wet).

Warning when the maximum permissible speed is exceeded

The system can warn you if you unintentionally exceed the maximum permissible speed. It is possible in this regard to specify in the multimedia system by how much the maximum permissible speed can be exceeded before a warning is issued. You can specify whether this warning is to be relayed visually only, or whether it is also to be accompanied by an acoustic warning.

Instrument cluster display

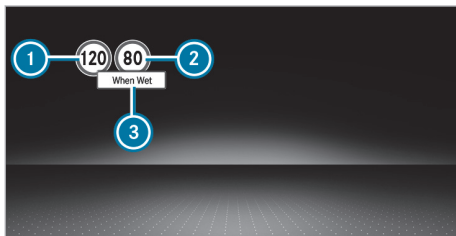

Instrument cluster (color display)

- ① Permissible speed
 - ② Permissible speed when there is a restriction
 - ③ Additional sign with a restriction
- ① Only one of traffic signs ① or ② is displayed at any one time in the instrument cluster, if necessary with additional sign ③. If two valid traffic signs are detected at the same time, a plus sign appears next to the traffic sign on the instrument cluster as an indication that both traffic signs are displayed in the navigation system.

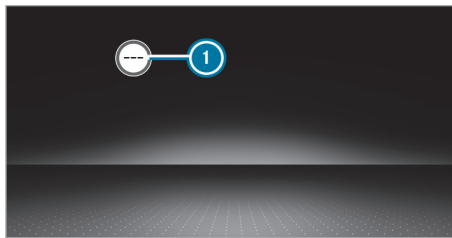

Traffic Sign Assist is not available in all countries. If it is unavailable, display ① is shown in the speedometer.

System limits

The system may be impaired or may be inoperative in the following situations:

- If visibility is poor, e.g. due to insufficient illumination of the road, highly variable shade conditions, rain, snow, fog, swirling dust or heavy spray.
- If there is glare, e.g. from oncoming traffic, direct sunlight or reflections.
- If there is dirt on the windshield in the vicinity of the multifunction camera or if the camera is fogged up, damaged or obscured.
- If traffic signs are difficult to detect, e.g. because they are dirty, obscured, faded, covered with ice, damaged, badly positioned, poorly lit or twisted.
- If the information in the navigation system's digital map is incorrect or out-of-date.
- If signs or the road layout are ambiguous, e.g. traffic signs in roadworks, at on- and off-ramps, in neighboring lanes or parallel roads.
- If signs do not conform to the standard.
- If signs or road layouts are specific to the respective country and deviate from the route guidance in the navigation system, e.g. in or after roadworks
- After sharp turns and tight bends, when traffic signs are outside the camera's field of vision.
- If you overtake vehicles with traffic signs which are affixed or attached to them.

Setting Traffic Sign Assist

Multimedia system:

- ▶  ▶ Settings ▶ Assistance
- ▶ Traffic Sign Assist

Switch on/off automatic adoption of speed restrictions

- ▶ Select [Accept Speed Limit](#).
- ▶ Activate or deactivate the function. Speed restrictions detected by Traffic Sign Assist are automatically adopted by Active Distance Assist DISTRONIC or cruise control.

Show detected traffic signs in media display

- ▶ Select [Display in Central Display](#).
- ▶ Activate or deactivate the function.

Set the type of warning

- ▶ Select [Visual & Audible](#), [Visual](#) or [Off](#).

Setting the warning threshold

This value determines the speed at which a warning is issued when exceeded.

- ▶ Select [Warning Threshold](#).
- ▶ Set a speed.

Blind Spot Assist

Function of Blind Spot Assist with exit warning

Blind Spot Assist uses two lateral, rear-facing radar sensors to monitor the area directly next to and on the side behind the vehicle.

- i** USA only:

This device has been approved by the FCC as a "Vehicular Radar System". The radar sensor is intended for use in an automotive radar system only. Removal, tampering, or altering of the device will void any warranties, and is not permitted by the FCC. Do not tamper with, alter or use in any non-approved way. Any unauthorized modification to this device could void the user's authority to operate the equipment.

⚠ WARNING Risk of accident despite Blind Spot Assist

Blind Spot Assist does not react to either stationary objects or vehicles approaching and overtaking you at a greatly different speed.

Blind Spot Assist cannot warn drivers in these situations.

- ▶ Always pay careful attention to the traffic situation and maintain a safe distance at the side of the vehicle.

Blind Spot Assist is only an aid. It may fail to detect some vehicles and is no substitute for attentive driving. Ensure that there is sufficient distance to the side from other road users and obstacles. If a vehicle is detected above speeds of approximately 7.5 mph (12 km/h) and this vehicle subsequently enters the detection range directly next to your vehicle, the warning lamp on the outside mirror will light up red.

- i** When a trailer is connected, the radar sensor's field of vision may be impaired, thereby making limited monitoring possible. Always pay close attention to the road and traffic conditions and maintain a safe distance at the side of the vehicle.

If a vehicle is detected close to your vehicle in the lateral detection range and you switch on the turn signal indicator in the corresponding direction, a warning tone will sound. The red warning lamp on the outside mirror will flash. If the turn indicator remains switched on, all other detected vehicles will be indicated only by the flashing of the red warning lamp.

If you overtake a vehicle quickly, no warning will be given.

Exit warning

The exit warning is an additional function of Blind Spot Assist and warns vehicle occupants of any approaching vehicles when leaving the vehicle.

⚠ WARNING Risk of accident despite exit warning

The exit warning neither reacts to stationary objects nor to persons or road users approaching you at a greatly differing speed.

The exit warning cannot warn drivers in these situations.

- ▶ Always pay particular attention to the traffic situation when opening the doors and make sure there is sufficient clearance.

- i** An exit warning will not be issued for sliding doors and rear doors.

Overview	
When the vehicle is stationary, an object is detected in the rearward detection range.	Red warning lamp on the outside mirror
When the vehicle is stationary, a door on the relevant side of the vehicle is opened. An object close to your vehicle is detected in the detection range.	Collision warning

- i** This additional function is available only when Blind Spot Assist is activated, and up to a maximum of three minutes after the drive system has been switched off. The end of the availability of the exit warning function will be indicated by a series of flashes on the outside mirror.

The exit warning function is only an aid and is no substitute for the attentiveness of the vehicle occupants. The responsibility for opening and closing the doors and for leaving the vehicle remains with the vehicle occupants.

System limits

Blind Spot Assist and the exit warning function may be limited in the following situations:

- if there is dirt on the sensors or the sensors are obscured
- if there is poor visibility, e.g. due to fog, heavy rain, snow or spray
- if narrow vehicles are within the detection range, e.g. bicycles
- in very wide lanes
- in very narrow lanes
- if vehicles are not driving in the middle of their lanes

- i** Stationary or slowly moving objects will not be displayed.

Warnings may be issued in error when you drive close to crash barriers or similar structural lane borders. Warnings may be interrupted when you drive alongside long vehicles, such as trucks, for a prolonged time.

Blind Spot Assist will not be operational when reverse gear is engaged.

The exit warning function may be limited in the following situations:

- when the sensor is blocked by adjacent vehicles in narrow parking spaces
- when people are approaching

Activating/deactivating Blind Spot Assist

Multimedia system:

  **» Settings » Assistance**

 Activate or deactivate **Blind Spot Assist**.

Drive Away Assist

Function of Drive Away Assist

- i** Drive Away Assist is available only for vehicles with automatic transmission.
- i** In the equipment without rear sensors, Drive Away Assist works only in the direction of travel forwards. (→ page 156).

Drive Away Assist can reduce the severity of an impact when pulling away. If an obstacle is detected in the direction of travel, the vehicle's speed is briefly reduced to approximately 1 mph (2 km/h). If a critical situation is detected, a symbol appears on the camera image of the multimedia system.

⚠ WARNING Risk of accident caused by limited detection performance of Drive Away Assist

Drive Away Assist cannot always clearly identify objects and traffic situations.

- ▶ Always pay careful attention to the traffic situation; do not rely on Drive Away Assist alone.
- ▶ Be prepared to brake or swerve as necessary, provided the traffic situation permits and that it is safe to take evasive action.

Drive Away Assist is only an aid. It is not a substitute for you paying attention to the surroundings. You are always responsible for safe maneuvering, parking and exiting a parking space. Make sure that no persons, animals or objects etc. are in the path of your vehicle.

A risk of a collision may arise in the following situations, foreexample:

- If the driver mixes up the accelerator and brake pedals.
- If the wrong gear is selected.

The Drive Away Assist function is active under the following conditions:

- If Parking Assist PARKTRONIC is activated.
- Every time the gear is changed to **R** or **D** when the vehicle is at a standstill.
- If the detected obstacle is less than approximately 3.3 ft (1.0 m) away.
- The maneuvering assistance function is activated in the audio system.

System limits

Drive Away Assist is unavailable on inclines and when driving with a trailer.

In the equipment without rear sensors, Drive Away Assist works only in the direction of travel forwards.

Rear Cross Traffic Alert

Function of Rear Cross Traffic Alert

The system uses the radar sensors in the bumper. This allows the area adjacent to the vehicle to be continually monitored. If the radar sensors are obscured by vehicles or other objects, detection is not possible.

i Also read the notes on Blind Spot Assist (→ page 165).

Vehicles with Blind Spot Assist: drivers can also be warned of any crossing traffic when backing up out of a parking space. If a vehicle is detected, the warning lamp in the outside mirror on the corresponding side lights up red. If a critical situation is detected, a warning tone also sounds.

Vehicles with Blind Spot Assist and Parking Assist PARKTRONIC: drivers can also be warned of any crossing traffic when backing up out of a parking space. If a critical situation is detected, a warning symbol appears on the camera image of the audio system. If the driver does not respond to the warning, the vehicle's brakes can be applied automatically. In this case, a warning tone sounds.

The Rear Cross Traffic Alert function is active under the following conditions:

- Blind Spot Assist is activated.
- Reverse gear is engaged or the vehicle is backing up at walking pace.
- The maneuvering assistant function is activated in the audio system.

The Rear Cross Traffic Alert function is unavailable when driving with a trailer.

Lane Keeping Assist and Active Lane Keeping Assist

Function of Lane Keeping Assist

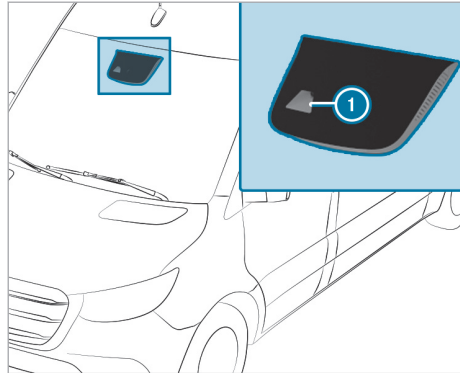

Lane Keeping Assist monitors the area in front of your vehicle with multifunction camera **1**. It serves to protect you against unintentionally leaving your lane. You may also be warned by a noticeable vibration in the steering wheel or by a warning tone and by the status symbol flashing on the instrument cluster.

The function is available in the speed range between approximately 40 mph (60 km/h) and 100 mph (160 km/h).

The warning will be issued when the following conditions are met at the same time:

- If Lane Keeping Assist detects lane markings.
- If a front wheel drives over lane markings.

You can activate and deactivate the Lane Keeping Assist warning.

If you fail to adapt your driving style, Lane Keeping Assist can neither reduce the risk of accident nor override the laws of physics. It cannot take into account road, weather or traffic conditions. Lane Keeping Assist is only an aid and is not intended to keep the vehicle in the lane without the driver's cooperation. You are responsible for the distance to the vehicle in front, for vehicle speed, braking in good time and for staying in your lane.

System limits

The system may be impaired or may not function in the following situations:

- If there is poor visibility, e.g. due to insufficient illumination of the road, if there are highly vari-

able shade conditions or in rain, snow, fog or spray.

- Glare from oncoming traffic, direct sunlight or reflections.
- There is dirt on the windshield in the vicinity of the multifunction camera or the camera is fogged up, damaged or obscured.
- Lane markings for one lane are absent or unclear, e.g. in a construction area.
- If the lane markings are worn away, dark or covered up.
- If the distance to the vehicle in front is too short and thus the lane markings cannot be detected.
- The lane markings change quickly, e.g. lanes branch off, cross one another or merge.
- The road is very narrow and winding.

■ Functions of Active Lane Keeping Assist

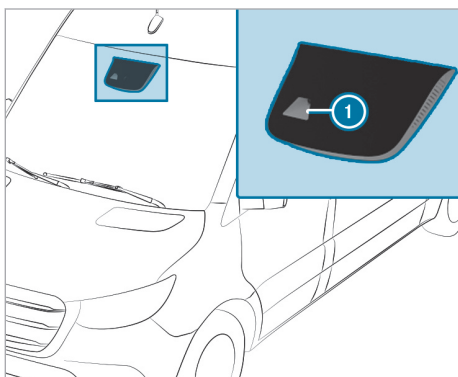

Active Lane Keeping Assist monitors the area in front of your vehicle by means of multifunction camera ①. It serves to prevent you from unintentionally leaving your lane. You may also be warned by a noticeable vibration in the steering wheel or by a warning tone and by the status symbol flashing on the instrument cluster. In addition, you may be guided back into your lane by a lane-correcting brake application. A corresponding message will appear on the instrument cluster.

The warning will be issued when the following conditions are met at the same time:

- The driving system detects lane markings.
- A front wheel drives over lane markings.

A lane-correcting brake application will occur when the following conditions are met:

- Active Lane Keeping Assist detects lane markings on both sides of the vehicle.
- A front wheel drives over a solid lane marking.

A corresponding message will appear on the instrument cluster.

The brake application is available in the speed range between approximately 40 mph (60 km/h) and 100 mph (160 km/h).

You can either deactivate the Active Lane Keeping Assist warning or switch off the system completely.

If you fail to adapt your driving style, Active Lane Keeping Assist can neither reduce the risk of an accident nor override the laws of physics. It cannot take into account road, weather or traffic conditions. The driving system is an aid for when the driver unintentionally leaves or crosses the lane and not a system for automatically keeping to the lane. You are responsible for maintaining a safe distance to the vehicle in front, vehicle speed, braking in good time and for staying in your lane.



If a lane-correcting brake application from Active Lane Keeping Assist occurs, indicator ① will appear on the instrument cluster display.

System limits

No lane-correcting brake application from Active Lane Keeping Assist will occur in the following situations:

- You clearly and actively steer, brake or accelerate.
- You switch on the turn signal indicator.
- A driving safety system intervenes, e.g. ESP® or Active Brake Assist.
- You have adopted a sporty driving style with high cornering speeds or high rates of acceleration.
- ESP® has been deactivated.

- When driving with a trailer, the electrical connection to the trailer has been correctly established.
- A tire pressure loss or a defective tire has been detected and displayed.

The system may be impaired or may be inoperative in the following situations:

- There is poor visibility, e.g. due to insufficient illumination of the road, highly variable shade, rain, snow, fog or heavy spray.
- There is glare from oncoming traffic, direct sunlight or reflections.
- There is dirt on the windshield in the vicinity of the multifunction camera or the camera is fogged up, damaged or obscured.
- There are no lane markings, or several unclear lane markings are present for one lane, e.g. in road work zones.
- The lane markings are worn away, dark or covered up.
- The distance to the vehicle in front is too short and thus the lane markings cannot be detected.
- The lane markings change quickly, e.g. lanes branch off, cross one another or merge.
- The road is very narrow and winding.

■ Activating/deactivating Lane Keeping Assist or Active Lane Keeping Assist

Multimedia system:

→  ► Settings ► Assistance

- ▶ Select Lane Keeping Assist or Active Lane Keeping Assist.
- ▶ Activate or deactivate the function.
- ▶ Select **Warning** and activate or deactivate.

Work mode

ADR (working speed control)

■ Function of ADR (working speed control)

When activated, ADR automatically increases the engine speed to a preset speed or a speed that you can set.

- ❗ After a cold start, the idle speed of the engine is increased automatically. If the preset working speed is lower than the increased idle speed, the working speed is reached only once the engine has completed the warm-up phase.

ADR can be activated only when the vehicle is stationary and the parking brake is applied. In vehicles with automatic transmission, the selector lever must be in position **P**.

■ Activating/deactivating ADR

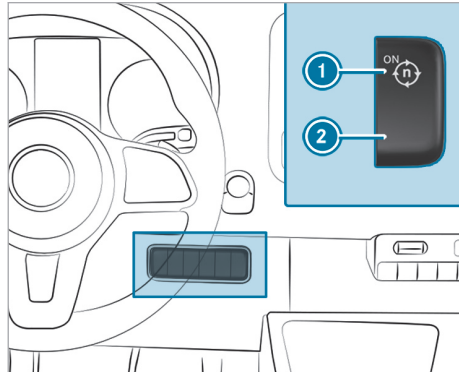

- ▶ **To activate:** press switch ① while the vehicle is running. The message **Working Speed Governor Active** will appear on the instrument cluster display.
- ▶ **To deactivate:** press switch ② while the vehicle is running.

ADR will deactivate automatically in the following situations:

- You release the parking brake.
- You depress the brake pedal.
- The vehicle moves.
- The control unit detects a malfunction.

■ Adjusting ADR

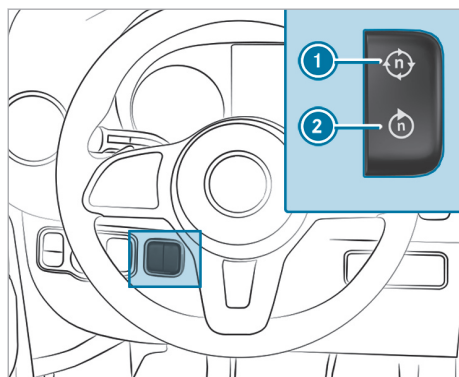

- ▶ Activate the power take-off or ADR.

- ▶ **To increase:** press the switch ①.
- ▶ **To reduce:** press the switch ②.

Trailer operation

Notes on trailer operation

⚠ WARNING Risk of accident and injury if the tongue weight is exceeded

The carrier system may detach from the vehicle, thereby endangering other road users.

- ▶ Always comply with the permissible tongue weight when using a carrier.

⚠ WARNING Risk of accident due to unsuitable ball neck

If you install an unsuitable ball neck, the trailer hitch and the rear axle may be overloaded.

This can significantly impair the driving characteristics and the trailer may become loose. There is a risk of fatal injury.

- ▶ Only install a ball neck that complies with the permissible dimensions and is designed for the requirements of trailer operation.
- ▶ Do not modify the ball neck or the trailer hitch.

You can find specifications regarding the ball neck on the trailer's identification plate. You can find specifications regarding the trailer on the towing vehicle's identification plate and in the Technical Data (→ page 280).

⚠ WARNING Risk of accident and injury due to incorrectly installed ball neck

If the ball neck is not properly mounted and secured, it may come loose along with the trailer while the vehicle is in motion and endanger other road users. There is a risk of fatal injuries.

- ▶ Mount and secure the ball neck as described in the installation instructions of the ball neck manufacturer.
- ▶ With the ball neck mounted, always make sure it is properly secured before commencing a journey.

⚠ WARNING Risk of accident due to a ball neck that is not correctly installed or secured

If the ball neck is not correctly installed and secured, the trailer may come loose.

- ▶ Install and secure the ball neck as described in the ball neck manufacturer's installation instructions.
- ▶ If a ball neck is installed, ensure sure that it is properly secured before every journey.

! NOTE Wearing out the brake linings by continuously depressing the brake pedal

- ▶ Do not depress the brake pedal continuously whilst driving.
- ▶ To use the braking effect of the engine, shift to a lower gear in good time.

! NOTE The operating permit may be invalidated due to the illegal installation of trailer hitches

The installation – including retrofitting – of a non-folding or non-removable trailer hitch that even partially conceals the license plate or the lighting system is prohibited.

- ▶ Observe the applicable legal regulations for the installation of trailer hitches.

Be sure to comply with the Operator's Manual of the manufacturer of the trailer coupling and the ball neck.

Place your vehicle/trailer combination on a surface that is as even as possible and secure it against rolling away (→ page 139). Couple and uncouple the trailer carefully.

When backing up the towing vehicle, ensure that there is no one between the vehicle and the trailer. If you do not couple the trailer to the towing vehicle correctly, the trailer may become detached. Once it has been coupled and is roadworthy, the trailer must be in a horizontal position behind the towing vehicle.

Note the following regarding the tongue weight:

- Make full use of the maximum tongue weight, where possible.
- Never allow the tongue weight to fall below a legally prescribed minimum; the tongue weight must always be positive.
- Do not exceed or fall below the permissible tongue weights – this must be observed during loading and unloading of the trailer.

Do not exceed the following values:

- Permitted braked or unbraked towing capacity
The maximum permissible towing capacity for unbraked trailers is 1,653 lbs (750 kg).
- Permissible rear axle load of the towing vehicle
- Gross vehicle weight rating of the towing vehicle
- Gross vehicle weight rating of the trailer
- Permissible gross combination weight
- Maximum permissible speed of the trailer

The relevant permitted values, which must not be exceeded, can be found in the following places:

- in your vehicle documents
- on the identification plate of the trailer hitch
- on the trailer identification plate
- on the vehicle identification plate

If there are discrepancies between the values, the lowest one shall apply.

Before driving off, ensure the following:

- The tire pressure on the rear axle of the towing vehicle has been set for the maximum load.
- The headlamps have been set correctly.

Values approved by the manufacturer can be found on the identification plates and in the section for the towing vehicle (→ page 241).

Your vehicle will behave differently with a trailer relative to without a trailer:

- The vehicle/trailer combination will be heavier.
- The vehicle/trailer combination will be restricted in its acceleration and gradeability.
- The vehicle/trailer combination will have an increased braking distance.
- The vehicle/trailer combination will be more susceptible to crosswind gusts.

- The vehicle/trailer combination will require more sensitive steering.
- The vehicle/trailer combination will have a larger turning circle.

This may impair the vehicle's driving characteristics.

When driving with a vehicle/trailer combination, always adapt your speed to the current road and weather conditions. Drive carefully. Keep a sufficient safe distance.

Comply with the maximum permissible speed of 50 mph (80 km/h) or 62 mph (100 km/h), even in countries in which higher speeds are permitted for vehicle/trailer combinations.

Attach only an approved trailer hitch to your vehicle. Use only a ball neck that has been approved for your vehicle. Further information about availability and installation – including that of the trailer electrics – is available from a qualified specialist workshop.

The trailer hitch is one of the most important vehicle parts for road safety. Comply with the instructions on operation, maintenance and servicing in the manufacturer's Operator's Manual.

i Your vehicle's bumpers are not suitable for installing detachable trailer hitches.

Do not attach any rented trailer hitches or any other detachable trailer hitches to the bumpers.

i During trailer operation, remember that PARKTRONIC is available only to a limited extent, if at all.

i The height of the ball head will change depending on the vehicle's load. In this case, use a trailer with a height-adjustable drawbar.

Driving notes

The maximum permissible speed for vehicle/trailer combinations depends on the type of trailer. Before setting off, consult the trailer's vehicle documents to find out the maximum permissible speed.

Your vehicle will behave differently with a trailer relative to without a trailer and will consume more fuel.

On long and steep downhill gradients, you must select shift range **3**, **2** or **1** in good time.

i This also applies if cruise control is switched on.

You will therefore make use of the engine's braking effect and will not have to brake as often to control the speed. This will take some of the strain off the

brake system and prevent the brakes from overheating and wearing too quickly. If you need additional braking, depress the brake pedal intermittently rather than continuously.

Observe the notes on ESP® trailer stabilization (→ page 146).

Driving tips

If the trailer starts to sway, remember the following points:

- Do not accelerate under any circumstances.
 - Do not countersteer.
 - If necessary, apply the brakes.
- i** You can reduce the risk of the trailer swaying and rocking by retrofitting stabilizer bar or trailer stability programs. You can obtain further information from an authorized Mercedes-Benz Center.

When you are driving with a trailer, observe the following points:

- Maintain a greater distance from the vehicle in front than when driving without a trailer.
- Avoid braking abruptly. If possible, brake gently first of all so that the trailer closes up behind your vehicle. Then, increase the braking force rapidly.
- The values given for start-off gradeability refer to sea level. When driving in mountainous areas, note that engine output – and thus start-off gradeability – will decrease with increasing altitude.

Coupling/uncoupling a trailer

Coupling a trailer

! **NOTE** Damage to the starter battery due to full discharge

Charging the trailer battery using the power supply of the trailer can damage the starter battery.

▶ Do not use the vehicle's power supply to charge the trailer battery.

- ▶ Shift the selector lever to position **P**.
- ▶ Apply the vehicle's parking brake.
- ▶ Close all the doors.
- ▶ Position the trailer on a level surface behind the vehicle.

i The height of the ball head will change depending on the vehicle's load. In this case, use a trailer with a height-adjustable drawbar.

- ▶ Couple up the trailer.
- ▶ Establish all electrical and other connections to the trailer.
- ▶ Remove objects or devices that are preventing the trailer from rolling, e.g. chocks.
- ▶ Release the trailer's parking brake.

i The vehicle subharness has a cable connection to the brake light indicator lamp.

Observe the maximum permissible trailer dimensions (width and length).

Most US states and all Canadian provinces prescribe the following points, and you are urgently recommended to comply with these:

- Safety chains between the towing vehicle and the trailer. The chains should be routed in a criss-cross pattern under the drawbar. They must be connected to the trailer hitch and not to the bumper or to the vehicle's axle. Leave sufficient slack in the chains. This also allows for sharp cornering.
- A separate brake system is required for certain trailers.
- A safety feature is required for braked trailers. Determine the specific requirements according to the relevant laws.

If the trailer becomes detached from the towing vehicle, the safety feature triggers the trailer brakes and can thus reduce the danger.

Uncoupling a trailer

! **WARNING** Risk of being crushed and becoming trapped when uncoupling a trailer

When uncoupling a trailer with an engaged inertia-activated brake, your hand may become trapped between the vehicle and the trailer drawbar.

▶ Do not uncouple trailers with an engaged overrun brake.

! **NOTE** Damage during uncoupling with an engaged overrun brake

The vehicle may be damaged if you uncouple with an engaged overrun brake.

▶ Do not uncouple trailers with an engaged overrun brake.

- ▶ Shift the selector lever to position **P**.
- ▶ Apply the vehicle's parking brake.
- ▶ Close all the doors.
- ▶ Apply the trailer's parking brake.
- ▶ Further secure the trailer against rolling away with a wheel chock or similar object.
- ▶ Remove the trailer cables and safety chains.
- ▶ Uncouple the trailer.

Information about towing a trailer

Operating a trailer is subject to many statutory regulations such as speed restrictions.

Many states also require an auxiliary separate functional braking system when towing a weight that exceeds a certain limit. For your safety, it is recommended to use a separate functional braking system on any towed vehicle.

Make sure that your trailer combination meets local regulations. This not only applies to your place of residence, but also to your destination. Information on this can be obtained from the police and local authorities.

Comply with the following when driving with a trailer:

- Practice cornering, stopping and backing up in a traffic-free location. In this way, you will gain driving experience and become accustomed to the new handling characteristics.
- Before driving, check the following:
 - that the trailer tow hitch and ball coupling are secure
 - that the safety switch for braked trailers is functioning correctly
 - that the safety chains are secure and undamaged
 - that the electrical connections are secure
 - that the lights are functioning correctly
 - the wheels for damage and correct tire pressure (→ page 238)
- Adjust the outside mirrors so that you have a clear view of the rear section of the trailer.
- If the trailer is equipped with an individual braking system, check before each journey whether the brakes are functioning correctly.
- If the trailer has electronically controlled brakes, pull away carefully with the vehicle/trailer combination. Brake manually using the brake controller and check whether the brakes are functioning correctly.
- Secure the load on the trailer in line with the requirements and rules for load-securing methods.
- When driving with a trailer, check at regular intervals that the load is secure and that the lights and brakes are functioning correctly.
- Bear in mind that the handling characteristics are more unstable when towing a trailer than when driving without a trailer. Avoid sudden steering movements.
- The vehicle/trailer combination is heavier, accelerates more slowly, has a reduced climbing ability and an increased braking distance. It is more susceptible to side winds and requires careful steering.
- If possible, do not brake suddenly, but rather moderately at first so that the trailer can activate its brakes. Then increase the pressure on the brake pedal.
- If the automatic transmission shifts between gears on uphill or downhill gradients, restrict the shift range. Select shift range 4, 3, 2 or 1. A lower gear and reduced speed decrease the risk of engine damage.
- When driving on a downhill gradient, shift to a lower gear to use the engine's braking effect. Avoid constant braking, as this could cause the vehicle brakes and possibly also the trailer brakes to overheat.
- If the coolant temperature increases significantly when the air-conditioning system is switched on, switch the air-conditioning system off. Coolant heat can also be dissipated by switching the airflow and the temperature of the heater or air conditioning to the maximum level. Open the windows if necessary.
- When overtaking, pay particular attention to the increased overtaking distance of your vehicle/trailer combination. Due to the length of your vehicle/trailer combination you will require a longer stretch of road before switching back to the original lane.

Permissible trailer loads and tongue weights

Weight information

⚠ WARNING Risk of accident due to an unbraked trailer with an excessive gross weight

If you pull an unbraked trailer with a gross trailer weight (GTW) of more than 1,653 lbs (750 kg), the vehicle's brake system may overheat.

This increases the braking distance and may even cause the brake system to fail.

▶ Always use a trailer with a separate braking system if you are pulling a gross trailer weight (GTW) of more than 1,653 lbs (750 kg).

ℹ NOTE Damage to the drive train, transmission or trailer tow hitch due to excess gross combination weight

The permissible gross combination weight is exceeded.

The drive train, the transmission or the trailer tow hitch may be damaged.

▶ Comply with the permissible gross combination weight.

In vehicles with a permissible gross vehicle weight of 11 030 lbs (5003 kg), the permissible gross combination weight is less than the sum of the permissible gross vehicle weight plus the permissible trailer load. If either the vehicle or the trailer is fully laden, the permitted gross vehicle weight or the permitted trailer load values will be reduced accordingly. In this case, you may only partially load the trailer or the vehicle.

The gross trailer weight (GTW) is calculated on the basis of the weight of the trailer plus the weight of its load and equipment. If the trailer is equipped with a separate braking system, then the maximum gross trailer weight is 5000 lbs (2268 kg) or 7500 lbs (3402 kg).

The maximum permissible drawbar tongue weight on the ball head is 500 lbs (227 kg) or 750 lbs (340 kg). However, the actual tongue weight must not exceed the value given on the trailer hitch or trailer identification plates. Where the values differ, the lowest shall always apply.

The gross combined weight rating (GCWR) is calculated on the basis of the gross trailer weight plus the gross vehicle weight, including a driver's

weight of approximately 150 lbs (68 kg). The maximum permissible gross combination weight is vehicle-specific and equipment-dependent. When driving with a trailer, you should not exceed the maximum permissible gross combination weight rating (GCWR).

The permissible values, which must not be exceeded, can be found in your vehicle documents and on the identification plates of the trailer hitch, the trailer and the vehicle. The values approved by the manufacturer can also be found in the "Technical data" section. Where the values differ, the lowest shall always apply.

Loading the trailer

Use a tongue weight that is as close as possible to the maximum permissible tongue weight. Do not allow the weight to fall below the minimum permissible tongue weight. Otherwise, the trailer may become detached.

- Distribute the load over the vehicle and the trailer so as not to exceed either the maximum permissible values for the gross vehicle weight rating (GVWR) and gross trailer weight (GTW), the gross combination weight rating (GCWR), or the maximum permissible gross axle weight rating (GAWR) and tongue weight (TWR) of your vehicle.
- Add the drawbar tongue weight (TWR) on the ball head to the rear axle load. This will ensure that you do not exceed the permissible gross axle weight rating (GAWR).
- Add the vehicle load to the drawbar tongue weight (TWR) on the ball head. This will ensure that you do not exceed the permissible gross vehicle weight rating (GVWR).

Checking vehicle and trailer weight

- Make sure that the weights of the towing vehicle and the trailer comply with the maximum permissible values. Have the vehicle/trailer combination weighed on a calibrated weighing machine. The vehicle/trailer combination comprises the towing vehicle including driver, passengers and load as well as the laden trailer.
- Check the maximum permissible gross axle weight rating of the front and rear axles (GAWR), the gross trailer weight (GTW), the gross combination weight rating (GCWR) and the drawbar tongue weight (TWR).

Trailer power supply

Incorrect cabling of the connector plug may interfere with other electronic systems in the vehicle. Mercedes-Benz therefore recommends that you have the cabling of the connector plug carried out at a qualified specialist workshop.

You can connect accessories up to a maximum of 240 W to the permanent power supply. Do not charge a trailer battery using the power supply.

Your vehicle may be equipped with a range of electrical equipment for trailer operation. Depending on your trailer, you may need an adapter for the electrical connection between the trailer and your vehicle.

The trailer socket of your vehicle is equipped with a permanent power supply at the factory.

The permanent power supply is supplied via trailer socket pin 4.

Note that the trailer's permanent power supply is not switched off when the vehicle's on-board electrical system voltage is low. This could completely discharge your vehicle's starter battery.

Further information on the electrical equipment currently installed on your vehicle and on installing the trailer electrics can be obtained at a qualified specialist workshop.

Overview of the instrument cluster

⚠ WARNING Risk of accident due to an Instrument Display malfunction

If the Instrument Display has failed or malfunctioned, the function restrictions applying to safety relevant systems are not visible.

The operating safety of your vehicle may be impaired.

- ▶ Drive on carefully.
- ▶ Have the vehicle checked immediately at a qualified specialist workshop.

If you are uncertain regarding the operational safety of your vehicle, park the vehicle safely as soon as possible. Inform a qualified specialist workshop.

Instrument cluster

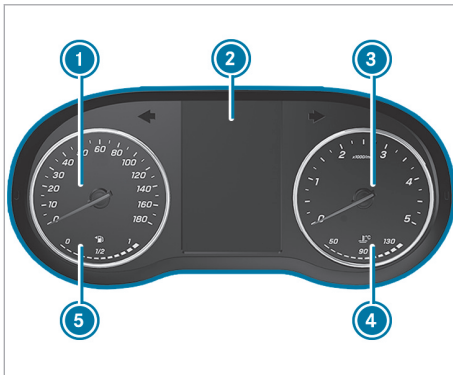

Instrument cluster with display (color)

- ① Speedometer
- ② Display (color)
- ③ Tachometer
- ④ Coolant temperature display
- ⑤ Fuel level and fuel filler flap location indicator

During normal driving, coolant temperature display ④ is permitted to rise to the red marking.

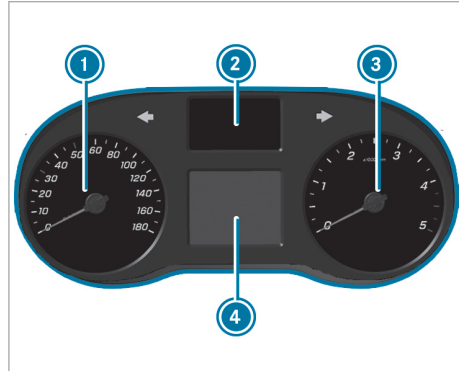

Instrument cluster with display (black and white)

- ① Speedometer
- ② Indicator lamps display
- ③ Tachometer
- ④ Display (black and white)

! NOTE Engine damage due to excessively high engine speeds

The engine will be damaged if you drive with the engine in the overrevving range.

- ▶ Do not drive with the engine in the overrevving range.

The fuel supply will be interrupted to protect the engine when the red mark on the tachometer ③ (overrevving range) is reached.

⚠ WARNING Risk of burns when opening the hood

If you open the hood in the event of an overheated engine or fire in the engine compartment, the following situations may occur:

- You may come into contact with hot gases.
- You may come into contact with other escaping hot operating fluids.

- ▶ Before opening the hood, allow the engine to cool down.
- ▶ In the event of a fire in the engine compartment, keep the hood closed and call the fire service.

Overview of the buttons on the steering wheel

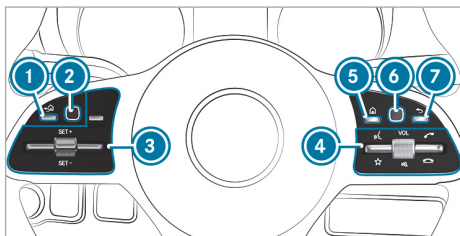

Variant 1

- ① Back button, left (on-board computer)
- ② Touch Control, left (on-board computer)
- ③ Button group for cruise control or Active Distance Assist DISTRONIC
- ④ Button group:
 - Voice control
 - Displays favourites (multimedia system). VOL: using the control, increases/reduces the volume or switches off the sound.
 - Makes/accepts a call.
 - Rejects/ends a call.
- ⑤ Main menu button (multimedia system)
- ⑥ Touch Control, right (multimedia system)
- ⑦ Back button, right (multimedia system)

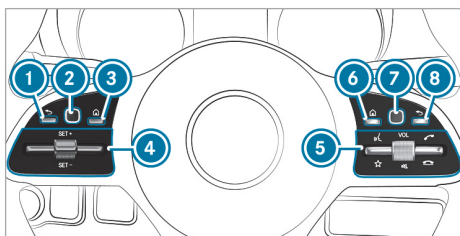

Variant 2

- ① Back button, left (on-board computer)
- ② Touch Control, left (on-board computer)
- ③ Main menu button (on-board computer)
- ④ Button group for cruise control or Active Distance Assist DISTRONIC
- ⑤ Button group:
 - Voice control
 - Displays favourites (multimedia system). VOL: using the control, increases/reduces the volume or switches off the sound.
 - Makes/accepts a call.
 - Rejects/ends a call.

- ⑥ Main menu button (multimedia system)
- ⑦ Touch Control, right (multimedia system)
- ⑧ Back button, right (multimedia system)

Operating the on-board computer

⚠ WARNING Risk of distraction from information systems and communications equipment

If you operate information systems and communication devices integrated in the vehicle when driving, you could be distracted from the traffic situation. This could also cause you to lose control of the vehicle.

- ▶ Only operate this equipment when the traffic situation permits.
- ▶ If you cannot be sure of this, stop the vehicle whilst paying attention to road and traffic conditions and operate the equipment with the vehicle stationary.

You must observe the legal requirements for the country in which you are currently driving when operating the on-board computer.

Operating the on-board computer (vehicles with steering wheel buttons)

- ① The displays for the on-board computer will appear on the instrument cluster display (→ page 178).

When the function is switched on, different acoustic signals will provide feedback while the on-board computer is being operated. These include an acoustic signal when the end of a list is reached or when a list is being scrolled through.

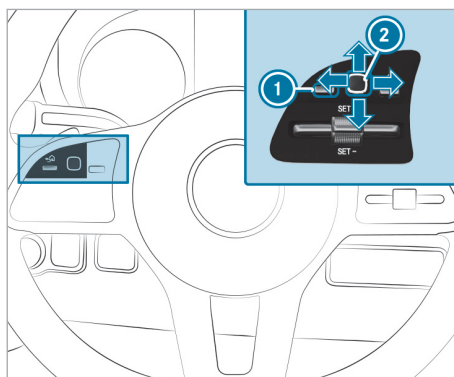

Variant 1

The on-board computer is operated via left-hand Touch Control **2** and left-hand back button **1**.

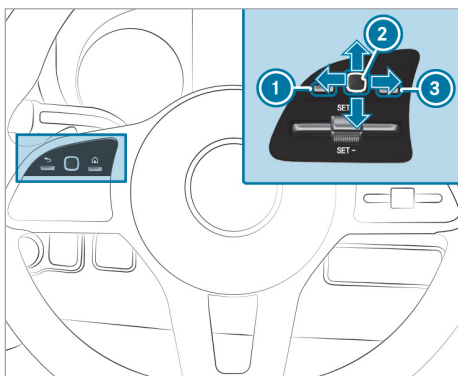

Variant 2

The on-board computer is operated using the following buttons:

- Left-hand back button **1**
- Left-hand Touch Control **2**
- Left-hand main menu button **3**

The following menus are available depending on the equipment:

- **Service** (→ page 179)
- **Radio** (→ page 182)
- **Trip** (→ page 180)
- **Media** (→ page 182)
- **Phone** (→ page 182)
- **DriveAssist** (→ page 179)
- **Settings** (→ page 183)

▶ **To call up the main menu:** press left-hand main menu button **3** or press left-hand back button **1** repeatedly, or press and hold this once.

i **Vehicles without Active Distance Assist DISTRONIC:** you can call up the main menu of the on-board computer with the  button.

▶ **To browse through the menu bar:** swipe to the left or right on left-hand Touch Control **2**.

▶ **To call up a menu or confirm a selection:** press left-hand Touch Control **2**.

▶ **To browse through displays or lists in the menu:** swipe upwards or downwards on left-hand Touch Control **2**.

▶ **To call up a submenu or confirm a selection:** press left-hand Touch Control **2**.

▶ **To exit a submenu:** press left-hand back button **1**.

If you are in a submenu and press and hold left-hand back button **1**, the main menu will appear.

Overview of the instrument cluster display

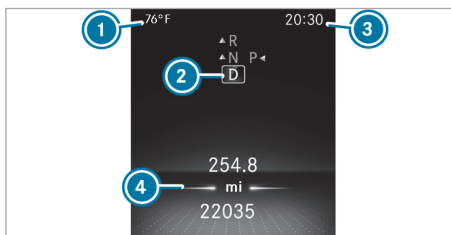

Example image: instrument cluster display (color)



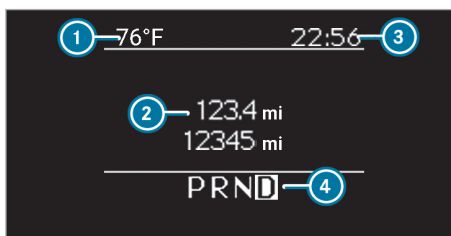

- 1** Outside temperature
- 2** Transmission position (→ page 125)
- 3** Time
- 4** Alternating display











Instrument cluster display (black and white)

- 1** Outside temperature
- 2** Alternating display
- 3** Time
- 4** Transmission position (→ page 125)

Further indicators on the instrument cluster display:

-  Gearshift recommendation
-  Parking Assist PARKTRONIC switched off (→ page 156)
-  Cruise control (→ page 149)
-  Active Distance Assist DISTRONIC (→ page 152)

	DSR (→ page 150)
	HOLD function (→ page 155)
	Adaptive Highbeam Assist (→ page 89)
	ATTENTION ASSIST switched off
	A door is not fully closed.
	Rear window wiper switched on (→ page 98)
SOS NOT READY	Emergency call system not active
	Active Lane Keeping Assist switched off (→ page 167)
	Active Brake Assist switched off (→ page 147)
	Blind Spot Assist switched off (→ page 165)

Vehicles with Traffic Sign Assist: instructions and traffic signs detected (→ page 163).

Adjusting the instrument lighting

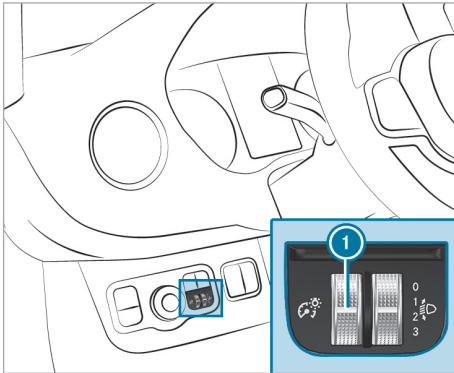

▶ Turn brightness control ① upwards or downwards.
The lighting of the instrument cluster and the controls in the vehicle interior will be adjusted.

① In vehicles without brightness control ①, the instrument lighting can be adjusted via the on-board computer (→ page 183).

Menus and submenus

Calling up functions on the service menu

On-board computer:

→ Service

▶ Select and confirm the desired function.

The following functions are available on the service menu:

- **Announcements:** message memory (→ page 285)
- **Additive (DEF):** displaying the DEF fill level (→ page 135)
- **Tires:**
 - checking the tire pressure with the tire pressure monitoring system (→ page 246)
 - restarting the tire pressure monitoring system (→ page 246)
- **ASSYST PLUS:** calling up the service due date (→ page 214)
- **Engine Oil Level:** measuring the engine oil level

Calling up the assistant display

On-board computer:

→ Service

▶ Select the desired display and confirm.

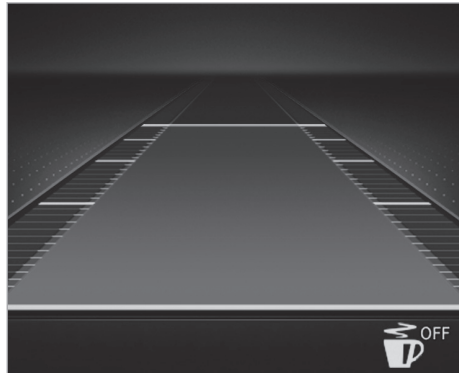

Instrument cluster display (color)

The following displays are available on the assistant display:

- Assistant display
- Attention level (→ page 162)

- ▶ Switch between the displays and confirm the selected display.



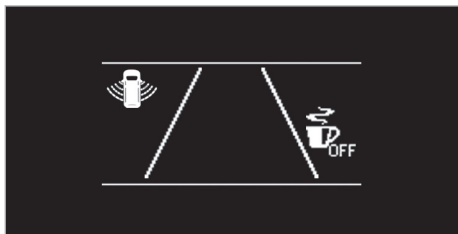

The following status displays are available on the assistant display:

-  ATTENTION ASSIST switched off
- Specified distance for Active Distance Assist DISTRONIC (→ page 152)



Instrument cluster display (black and white)

The following status displays are available on the assistant display:

- Lane markings solid and thick: Lane Keeping Assist on and ready to issue warnings
- Lane markings solid and thin: Lane Keeping Assist on and not ready to issue warnings
- Lane markings dotted: Lane Keeping Assist off
-  ATTENTION ASSIST off
-  Blind Spot Assist on and ready to issue warnings (lines of the radio waves solid)
-  Blind Spot Assist on and not ready to issue warnings (lines of the radio waves broken)
-  Blind Spot Assist off

Calling up displays on the Trip menu

On-board computer:



- ▶ Select the desired display and confirm.

The following displays are available on the trip menu:

- Standard display
- Range and current fuel consumption
 - With certain engines, a recuperation display will also be shown. If only a small amount of fuel is left in the fuel tank, a vehicle being refueled will appear instead of the approximate range.
- ECO display (→ page 122)

- Trip computer:
 - From Start
 - From Reset
- Digital speedometer

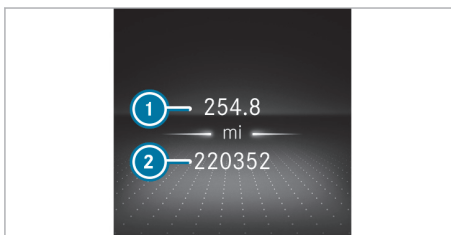

Instrument cluster display (color)
Standard display (example)

- ① Trip distance
- ② Total distance

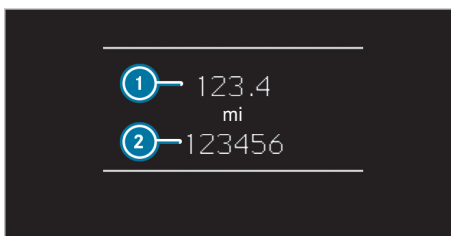

Instrument cluster display (black and white)
Standard display (example)

- ① Trip distance
- ② Total distance

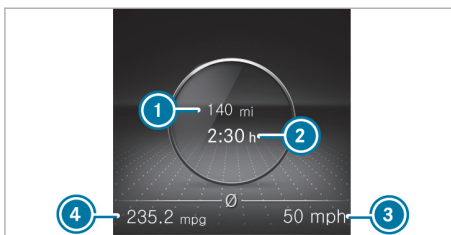

Instrument cluster display (color)
Trip computer (example)

- ① Distance covered (from start/from reset)
- ② Driving time (from start/from reset)
- ③ Average speed (from start/from reset)
- ④ Average fuel consumption (from start/from reset)

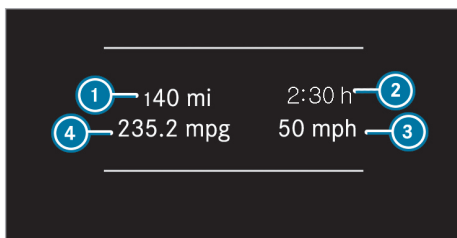

Instrument cluster display (black and white)

Trip computer (example)

- ① Distance covered (from start/from reset)
- ② Driving time (from start/from reset)
- ③ Average speed (from start/from reset)
- ④ Average fuel consumption (from start/from reset)

Resetting values on the trip menu of the on-board computer

On-board computer:

→ Trip

- ⓘ The wording may differ on the main menu displayed. Therefore, pay attention to the menu overview for the instrument cluster (→ page 177).

You can reset the values of the following functions:

- Trip Odometer:
 - Reset Trip Odometer?
- Trip computer:
 - From Start
 - From Reset
- ECO display

▶ Select the function for which the value is to be reset and confirm this selection.

▶ Confirm the prompt **Reset Values?** with **Yes**.

Calling up navigation instructions on the on-board computer

On-board computer:

→ Trip

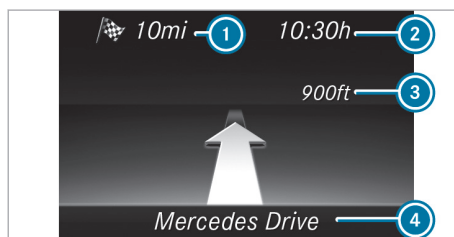

No change of direction announced (example)

- ① Distance to the next destination
- ② Estimated arrival time
- ③ Distance to the next change of direction
- ④ Name of current road

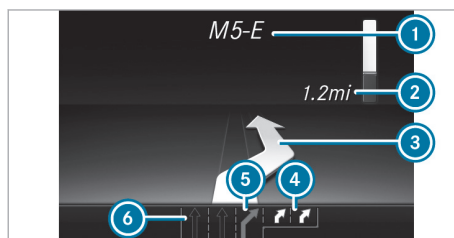

Change of direction announced (example)

- ① Road to which the change of direction leads
- ① Destination route of the change of direction
- ② Distance to the change of direction
- ③ Change-of-direction symbol
- ④ Recommended lane and new lane during a change of direction (white)
- ⑤ Possible lane
- ⑥ Lane not recommended (dark gray)

Further possible displays are available on the Navigation menu:

- **Direction of Travel:** The direction of travel and the road currently being traveled are displayed.
- **New Route...** or **Calculating Route...:** A new route is being calculated.
- **Road Not Mapped:** The road is not known, e.g. it has only recently been built.
- **No Route:** The route to the selected destination cannot be calculated.

- **Off Map:** The map for the current position is not available.
- **Area of Destination Reached:** You have reached the destination area.
- **Destination Reached:** You have reached the destination or an intermediate destination.

▶ Exit the menu or select and confirm a destination.
If a destination is entered and confirmed, route guidance will start.

▶ If route guidance was previously active, a query will appear asking whether the current route guidance is to be terminated.

▶ Confirm the prompt.
Route guidance will start.

Selecting a radio station

On-board computer:

➔ Radio



- 1 Frequency range
- 2 Station
- 3 Name of track
- 4 Artist's name

The following displays are available:

- Frequency range
- Station list

▶ Select the radio station's frequency or a radio station from the station list.

▶ Confirm the selection.

When you select a station in the station memory, the memory preset appears beside the station name. When you select a saved station in the frequency range, a star appears beside the station name.

Operating media playback with the on-board computer

On-board computer:

➔ Phone

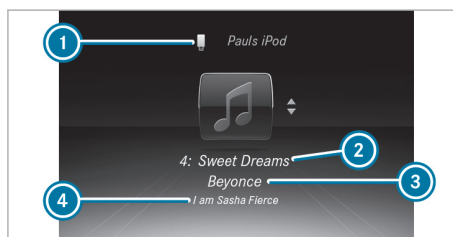

- 1 Media source
- 2 Current track and track number
- 3 Artist's name
- 4 Name of album

The following displays are available in the media menu:

- Media source selection list
- Current playback

▶ Select and confirm the media source.

▶ Select and confirm the required playback.

- ⓘ This is how to select a station when TV is the media source.

Dialing a telephone number using the on-board computer

⚠ WARNING Risk of distraction from information systems and communications equipment

If you operate information systems and communication devices integrated in the vehicle when driving, you could be distracted from the traffic situation. This could also cause you to lose control of the vehicle.

▶ Only operate this equipment when the traffic situation permits.

▶ If you cannot be sure of this, stop the vehicle whilst paying attention to road and traffic conditions and operate the equipment with the vehicle stationary.

When using the phone, you must observe the legal requirements for the country in which you are currently driving.

Requirements:

- The mobile phone is connected to the multimedia system.

On-board computer:



Select one of the following options:

- Previous calls
- Phone book
- Call status

Vehicles with MBUX multimedia system: the most recent telephone calls (dialed numbers, accepted and missed calls) are displayed on the **Assistance** menu.

▶ Select and confirm a telephone number.
If only one telephone number has been saved for the entry: the telephone number will be dialed.

▶ **If multiple telephone numbers have been saved for the entry:** select and confirm a telephone number.
 The telephone number will be dialed.

Instead of the selected telephone numbers, the following displays may appear:

- **Please Wait:** The application is currently starting. If no Bluetooth® connection to the mobile phone is established, the menu for authorizing and connecting a mobile phone will be displayed in the multimedia system .
- **Updating Data...:** The call list is being updated.
- **Importing Contacts:** The mobile phone's contacts or a memory medium's contacts are being imported.

Accepting/rejecting a call

When you receive a call, the **Incoming Call** message will appear on the display.

▶ Press to accept the call or to reject it.

You can also accept or reject the call using the or buttons on the steering wheel.

Calling up settings on the on-board computer

On-board computer:



The following entries can be configured on the Settings menu:

- **Light**
 - Setting **Instr. Clust. Light**.
- **Vehicle**
 - Setting **Rain Sensor** basic sensitivity
- Setting **Heating**
- **Display and Operation**
 - Switching permanent **Display Additive (DEF)** on/off

- ▶ Select an entry and confirm the selection.
- ▶ Make the necessary changes.

Mercedes me calls

Making a call via the overhead control panel

- ① Mercedes me calls are not possible in every country. Contact an authorized Mercedes-Benz Center to find out whether these functions are available in your country.
- ① Please note that product scopes can vary depending on the model series, year of production and equipment, as well as between private and commercial user accounts.

The following services have no limitation in the term:

- Accident and Breakdown Management
- Maintenance management
- Telediagnosics

Other services can be extended at the end of the initial term for a fee. The first activation of the services by the customer is possible within one year of initial registration or commissioning, depending on which happens first.

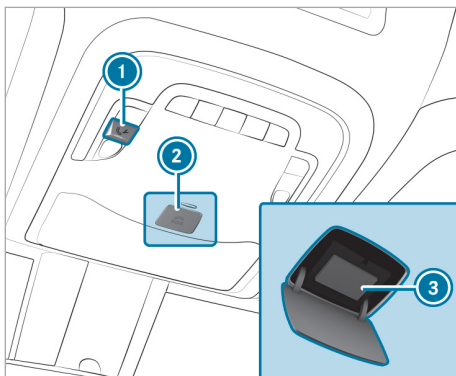

- ① Breakdown assistance call button
- ② Cover for button (SOS button)
- ③ button (SOS button)

Making a breakdown assistance call

- ▶ Press button ①.

Making an emergency call

- ▶ Briefly press the cover on button ② to open it.
- ▶ Press and hold button ③ for at least one second.

An emergency call can still be triggered when a breakdown assistance call is active. This has priority over all other active calls.

Information about the Mercedes me call using the overhead control panel

A call to the Mercedes-Benz Customer Center using the breakdown assistance call button in the overhead control panel has been initiated (→ page 184).

You are connected to the Mercedes-Benz Customer Center. A specialist at the Mercedes-Benz Customer Center will register your accident or breakdown report.

This specialist may put your call through to other services:

- Mercedes me connect Business
- Mercedes-Benz Customer Center for general information about the vehicle

Depending on the issue, the specialist at the Mercedes-Benz Customer Center will forward your call to the appropriate body.

- ① It is not possible to forward the call in every country.

You can find information on the following topics:

- Activation of Mercedes me connect
- Operating the vehicle
- Nearest authorized Mercedes-Benz Center
- Other products and services from Mercedes-Benz

If the Accident Recovery and Breakdown Management service is activated, data is transmitted during the connection to the Mercedes-Benz Customer Center (→ page 186).

If the service is not activated, a pop-up window appears. You can agree or refuse to the data transfer.

The Mercedes me connect services can be activated in the Mercedes me Portal (→ page 188).

Calling the Mercedes-Benz Customer Center using the multimedia system

Requirements:

- MBUX multimedia system is available in the vehicle.
- Access to a mobile phone network is available.

- The contract partner's mobile network coverage is available in the respective region.
- The vehicle must be switched on so that vehicle data can be transferred automatically.

Multimedia system:



▶ Call **Mercedes me connect**.

With your consent, the multimedia system sends the required vehicle data. The data transfer is shown in the media display.

You can reach the desired service via the voice dialog system:

- Accident and Breakdown Management
- Mercedes me connect Business
- Mercedes-Benz Customer Center for general information about the vehicle

You will then be connected to a specialist at the Mercedes-Benz Customer Center.

Calling the Mercedes-Benz Customer Center after automatic accident or breakdown detection

Requirements:

- The vehicle has detected an accident or breakdown situation.
- The vehicle is stationary.
- The hazard warning light is switched on.

Vehicles with the multimedia system

i This function is not available in all countries.

If an accident or breakdown is detected, the emergency guide shows safety instructions in the multimedia system display. This may take a few seconds.

After quitting the emergency guide display on the multimedia system, a prompt appears asking whether you wish to get support from the Mercedes-Benz Customer Center.

▶ Select **Call**.

- After your agreement, or if the Mercedes me connect service "Accident and Breakdown Management" is active, the vehicle data is transferred automatically (→ page 187).
- The Mercedes-Benz Customer Center will take your call and organize breakdown and accident assistance.

You may be charged for these services.

i If the service is available: in addition, if the Mercedes me connect "Telediagnosics" service is active, a similar query may appear at a later time in the event of a breakdown. If you are already in contact with the Mercedes-Benz Customer Center or have received help, this query can be ignored or rejected.

i If you answer the prompt for support from the Mercedes-Benz Customer Center with **Later** the message will disappear and reappear at a later time.

The query triggered by the "Telediagnosics" Mercedes me connect service can either be confirmed or rejected. After rejection, it is no longer displayed.

Arranging a service appointment via Mercedes me call

If you have activated the maintenance management service, relevant vehicle data is transferred automatically to the Mercedes-Benz customer center. You will then receive individual recommendations regarding the maintenance of your vehicle. You will receive an offer for the upcoming maintenance scopes from the service partner stored in Mercedes me.

Regardless of whether you have consented to the maintenance management service, the multimedia system reminds you after a certain amount of time that a service is due. A prompt appears asking if you would like to make an appointment.

▶ **To arrange a service appointment:** select **Call**.

After your confirmation, the vehicle data is sent and the Mercedes-Benz customer center deals with your appointment. The information is then sent to your desired service outlet.

They will contact you to confirm the appointment and, if necessary, to discuss the details.

i If you select **Later** after the service message appears, the message is hidden and reappears at a later time.

i No request for consent to data transfer is made, if the Mercedes me connect Accident and Breakdown Management service is activated.

Consenting to data transfer for a Mercedes me call

Requirements:

- There is an active Mercedes me call via the multimedia system or the buttons in the overhead control panel (→ page 184).
- ⓘ The prompt to confirm data transfer does not appear in all countries.

Select Yes.

Relevant identification data is transmitted automatically.

More information on Mercedes me: <https://www.mercedes.me>

Transferred data during a Mercedes me call

When you make a service call via Mercedes me, data is transmitted. This enables targeted advice and smooth service.

The following requirements must be met for the data transfer:

- The vehicle is switched on.
- The necessary data transmission technology is supported by the mobile phone network provider.
- A sufficient mobile phone connection quality is provided.

Multi-stage transmission depends on the following factors:

- Reason for the initiation of the call
- Available mobile radio transmission technology
- Activated Mercedes me connect services
- Selected service in the voice dialog system
- ⓘ A request for consent to data transfer is only made if the corresponding Mercedes me connect service has not been activated.
- ⓘ The scope of the transmitted data depends on the vehicle model and equipment. For technical reasons not all data is available at all times.
- ⓘ The prompt to confirm data transfer does not appear in all countries.

Data transfer when Mercedes me connect services are not activated

If no Mercedes me connect services are activated and the data protection query has been confirmed, the following data will be transferred:

- Vehicle identification number
- Time of the call
- Reason for the initiation of the call
- Confirmation of the data protection prompt
- Vehicle country code
- Set language for the multimedia system
- Call number of the communication platform installed in the vehicle

If a call is made for a service appointment via the service reminder, the following data is also transmitted:

- Current mileage and maintenance data

If a call was made via the multimedia system after automatic accident or breakdown detection, the following data is also transmitted:

- Current mileage and maintenance data
- Estimated number of people in the vehicle

The detection is based on the number of closed seat belt buckles on the front seats.

If the Accident and Breakdown Management selection has been made via the voice dialog system and no service has been activated, but the data protection query has been confirmed, the following data can be additionally requested from the vehicle by the Mercedes-Benz Customer Center:

- Current vehicle location

If the data protection request has been declined, the following data will be transferred to enable targeted advice and a smooth service:

- Reason for the initiation of the call
- Rejection of the data protection prompt
- Vehicle country code
- Set language for the multimedia system
- Call number of the communication platform installed in the vehicle

Data transfer when Mercedes me connect services are activated

Only in the second step, only for the respective activated services, further case-specific data is transmitted in order to enable an optimal service.

An overview of the data transmitted can be found in the respective terms of use for Mercedes me connect services. You can obtain these in the Mercedes me Portal at: <https://www.mercedes.me>

Data processing

The data transmitted as part of the call will be deleted from the transmitting systems once the call has been completed, provided they are not used for other activated Mercedes me connect services.

The case-related data will be processed and stored in the Mercedes-Benz Customer Center and, if necessary for case processing, forwarded to the service partners commissioned by the Mercedes-Benz Customer Center. Please refer to the data protection information on the Mercedes me website at <https://www.mercedes.me> or in the recorded message immediately after the call to the Mercedes-Benz Customer Center has been set up.

- i The recorded message is not available in every country.

Mercedes me connect

Information about Mercedes me connect

- i Mercedes me connect or individual Mercedes me connect services are not available in every country. Contact an authorized Mercedes-Benz Center to find out whether these functions are available in your country.
- i Please note that product scopes can vary depending on the model series, year of production and equipment, as well as between private and commercial user accounts.

Mercedes me connect comprises a number of services.

Using the multimedia system or the overhead control panel, if available, you can use the following services, for example:

- Accident and Breakdown Management (Breakdown assistance call button or the situation-dependent display in the multimedia system)
- Emergency call system (automatic emergency call and SOS button)

Mercedes me connect Accident and Breakdown Management and the Mercedes-Benz emergency call center are available to you around the clock.

You will find the breakdown assistance call button and the SOS button in the vehicle's overhead control panel (→ page 184).

If the multimedia system is available in the vehicle, you can also call the Mercedes-Benz Customer Center using the multimedia system (→ page 184).

Please note that Mercedes me connect is a Mercedes-Benz service. In emergencies, call the national emergency services first using the standard national emergency service phone numbers. In emergencies, you can also use the emergency call system (→ page 226).

Observe the conditions of use for Mercedes me connect and other services. These can be obtained in the Mercedes me Portal: <https://me.secure.mercedes-benz.com>

Further information about Mercedes me connect services can be obtained in the Mercedes me Portal: <https://me.secure.mercedes-benz.com>

Information on Mercedes me connect Accident and Breakdown Management

- i Accident and Breakdown Management is not available in every country. Contact an authorized Mercedes-Benz Center to find out whether this function is available in your country.

The Accident and Breakdown Management can, amongst others, include the following functions:

- Supplement to the Emergency Call System (→ page 226)
 - If necessary, the contact person at the Mercedes-Benz emergency call center forwards the call to Mercedes me connect Accident and Breakdown Management. However, call forwarding is not possible in all countries.
- Breakdown assistance on location by a technician and/or towing away of the vehicle to the nearest authorized Mercedes-Benz Center
 - You may be charged for these services.
- In the event of a breakdown or accident, extended vehicle data is sent, enabling optimum support from the Mercedes-Benz Customer Center and the appointed service partner or breakdown mechanic.
- If available: addition to the Mercedes me connect Telediagnosics service

With the Telediagnosics function, the service provider records certain wear and failure mes-

sages, insofar as these can be clearly interpreted and are available by monitoring diagnosable components.

If your vehicle detects a breakdown or impending breakdown, you may be prompted via the multimedia system to contact the Mercedes-Benz Customer Center for further assistance. This prompt in the multimedia system only appears when the vehicle is stationary.

- ① These services are subject to technical restrictions such as mobile coverage and mobile network quality and the interpretability of the transmitted data in the processing systems. Under certain circumstances, this may result in delays or omission of the message in the multimedia system.

Please note that the Mercedes me call is a Mercedes-Benz service. In the event of an emergency always call the national emergency services first or use the Mercedes-Benz emergency call system (→ page 226).

Further information about Mercedes me connect services can be obtained in the Mercedes me Portal: <https://me.secure.mercedes-benz.com>

Data transferred during Mercedes me connect call services

The data transferred during the Mercedes me connect call depends on:

- The reason for the initiation of the call
- The service selected in the voice dialog system
- The activated Mercedes me connect services

The data which is transferred is listed in the currently valid terms of use and data protection information of Mercedes me connect. These can be found at: <https://www.mercedes.me> under "My Mercedes me account", "Terms of use".

Mercedes me and apps

Information about Mercedes me

Requirements:

- To use the services, registration in the Mercedes me Portal must have been carried out.
- The terms of use for Mercedes me connect services have been agreed to.
- The services are activated.

The services can be activated in the Mercedes me Portal via the path **Manage vehicle > My services**.

When you log in with a user account to the Mercedes me Portal, then services and offers from Mercedes-Benz will be available to you.

- ① Please note that product scopes can vary depending on the model series, year of production and equipment, as well as between private and commercial user accounts.

Availability is country-dependent.

For more information consult an authorized Mercedes-Benz Center or visit the Mercedes me Portal: <https://me.secure.mercedes-benz.com>.

- ① Make sure that you always keep the Mercedes me Apps up to date.

Calling up a Mercedes me user account

Requirements:

- You have a user account for the Mercedes me Portal.
- The vehicle is linked to the user account and you have accepted the terms of use for the Mercedes me connect services.
- The Personalization service is activated on Mercedes me connect.

Multimedia system:

→  → **Mercedes me & Apps**

▶ Select a menu option.

or

▶ Call up **General Settings** and switch one of the synchronization functions on or off.

Vehicle is linked to user account

▶ Select **Mercedes me**.
Information about the linked user account appears.

Your vehicle is not linked to the user account

- ① If you do not yet have a Mercedes me user account, you can create one at: <https://www.mercedes.me> or in the Mercedes me App. A valid email address or phone number is required for this.

▶ Select **Mercedes me**.

▶ Follow the instructions on the media display to link the user account with the vehicle.

- ① Linking via the instructions on the media display is then only possible if an MBUX multimedia system is installed in the vehicle.
- ① If the Mercedes me App is available on a mobile phone, the vehicle link can be made via the displayed QR code.

Calling up Mercedes me services

Requirements:

- The vehicle is connected with the user account.

Multimedia system:

→  » Mercedes me & Apps

▶ Select **Services**.

You will be shown the Mercedes me services that you have already purchased and those that you can also still purchase within the various categories.

To activate or deactivate the services, log in to the Mercedes me Portal with your user account.

Removing the link between the user account and the vehicle

Requirements:

- The user profile of the user account that was first linked to the vehicle is selected.
- The profile is synchronized.
- A PIN has been saved.

Multimedia system:

→  » Mercedes me & Apps

▶ Mercedes me

▶ Select **Delete Vehicle Assignment**.

▶ Enter the PIN of the linked user account.

- ① Only the user whose user account was linked to the vehicle first can remove the link between all user accounts and the vehicle.
- ① Alternatively, linking can be removed in the Mercedes me Portal or in the Mercedes me App (Remove vehicle).

Overview and operation

Notes on MBUX multimedia system

⚠ WARNING Risk of distraction from information systems and communications equipment

If you operate information systems and communication devices integrated in the vehicle when driving, you could be distracted from the traffic situation. This could also cause you to lose control of the vehicle.

- ▶ Only operate this equipment when the traffic situation permits.
- ▶ If you cannot be sure of this, stop the vehicle whilst paying attention to road and traffic conditions and operate the equipment with the vehicle stationary.

You must observe the legal requirements for the country in which you are currently driving when operating the multimedia system.

Overview of the MBUX multimedia system

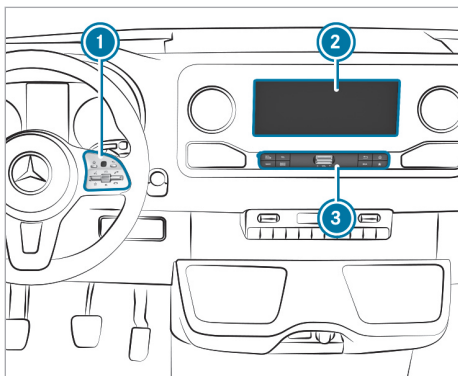

- ① Touch Control and multimedia system control panel
- ② Media display with touch functionality
Opens/closes the center console stowage compartment above the display
- ③ Operating strip, calls up applications
- ⓘ You can find further information about operation as well as about applications and services in the Digital Operator's Manual.

In the center console stowage compartment you can find the following ports and interfaces:

- Two USB ports or one USB port
The USB port with the  symbol facilitates the connection of the mobile phone with the multimedia system using a suitable cable. This will enable you to use the functions of the mobile phone via Apple CarPlay® or Android Auto.
- Stowage space with charging interface and NFC interface (if available)

Notes on the media display

Observe the notes on caring for the interior (→ page 224).

Automatic temperature-controlled switch-off feature: if the temperature is too high, the brightness is initially reduced automatically. The media display may then switch off completely for a while.

- ⓘ If you are wearing polarized sunglasses, it may be difficult to read the media display.

Anti-theft protection

This device is equipped with technical provisions to protect it against theft. Further information on protection against theft can be obtained from an authorized Mercedes-Benz Center.

Home screen overview

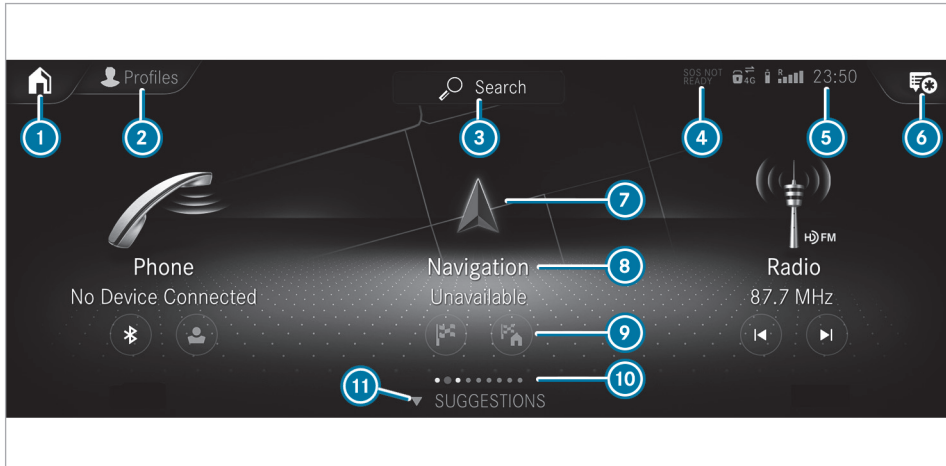

- ① On the home screen: displays the first three applications
In other displays: calls up the home screen
- ② Calls up the profile
- ③ Calls up the global search
- ④ SOS NOT READY display only when the emergency call system (eCall) is not available
- ⑤ Displays, e.g. network display, battery status of the mobile phone connected, signal strength of the mobile phone network, time
- ⑥ Calls up the Notifications Center
The star indicates new notifications.
- ⑦ Calls up an application using the symbol
- ⑧ Name of the application, beneath the current selection or information
- ⑨ Quick-access (in the example: calls up destination entry and enters the destination address for home)
- ⑩ Number of applications and currently selected display area
- ⑪ Calls up **SUGGESTIONS** and **FAVORITES**

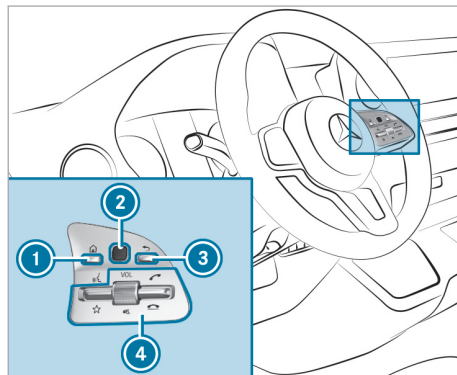

Operating the MBUX multimedia system

Using Touch Control



- ① button
Calls up the home screen
- ② Touch Control
- ③ Back button
Returns to the previous display
- ④ Control panel for multimedia system
Press the rocker switch down: shows favorites
Turn the controller: adjusts the volume
Press the controller: switches sound off
Press the rocker switch up: makes or accepts a call
Press the rocker switch down: ends or declines a call

Navigation through the menus is carried out with Touch Control  with single-finger swipes.





- ▶ **To open a menu or list:** press Touch Control .
- ▶ **To select a menu option:** swipe and press.
- ▶ **To close a menu or list:** press button .
- ▶ **To move the digital map:** swipe in any direction.

Using the touchscreen

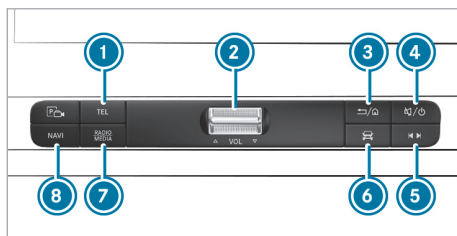
- ▶ **To navigate in menus:** swipe up, down, left or right.
- ▶ **To select an entry:** tap on the entry.
- ▶ **To enter characters with the keyboard:** tap on a button.
- ▶ **To use handwriting to enter characters:** write the character with one finger on the touchscreen.
- ▶ **To zoom in and out of the map:** move two fingers together or apart.
- ▶ **To enlarge or reduce the size of a section of a website:** move two fingers together or apart.
- ▶ **To call up a global menu in the applications:** touch the touchscreen and hold until the **OPTIONS** menu appears.

Calling up applications using buttons





- ① **TEL** button
Calls up the telephone
- ② Volume rocker switch
Adjusts the volume
- ③  /  button
Press briefly: returns to the previous display
Press and hold: calls up the home screen
- ④  /  button
Press briefly: switches sound off
Press and hold: activates or deactivates the multimedia system
- ⑤ Quick-access button for media

Calls up the control menu of the last active media source

- ⑥ Vehicle button
Sets vehicle functions
- ⑦  button
Pressing repeatedly calls up the desired audio source
- ⑧ **NAVI** button
Calls up navigation

- ▶ Alternatively, tap  on the touchscreen.
- ▶ Call up the application.

Quick-access to stations and music tracks

- ▶ Press button .
- The control menu appears for the audio source that was last selected.
- ▶ Swipe to the left or right.
Radio: the previous or next station is set.
Media source: the previous or the next music track is selected.
- ▶ **To hide the control menu:** press button .

Function of the Voice Control System

If you use the voice control system in an emergency your voice can change and your telephone call, e.g. an emergency call, can thereby be unnecessarily delayed.

Familiarize yourself with the voice control system functions before starting the journey.

With the Voice Control System, various applications of the MBUX multimedia system can be operated by voice input. The Voice Control System is operational approximately thirty seconds after the vehicle is switched on and is available from the driver's and front passenger's seat.

The following applications of the multimedia system can be operated:

- Navigation
- Telephone
- Radio
- Media player
- Messages
- Vehicle functions

Starting the Voice Control System

- ▶ Press the  rocker switch up on the multi-function steering wheel. You can say a voice command after the acoustic signal.

Information on profiles, suggestions and favorites

Using the multimedia system up to seven profiles can be created in the vehicle.

Profiles store your personal vehicle settings and settings for the multimedia system.

If the vehicle is used by several drivers, the driver can select their profile before the journey, without changing the settings of other drivers.

The following settings are saved in your profile, for example:

- Radio (including station list)
- Last destinations
- Favorites and suggestions

The vehicle can learn the habits of the driver. It then offers suggestions for the most likely navigation destinations, media sources, radio stations or contacts. The requirements for that are the selection of a profile, your consent to the recording of data and sufficient collected data.



Favorites are quick accesses to frequently used applications. Favorites can be selected from categories or added directly in an application.

Configuring profiles and suggestions

Multimedia system:

   Profiles

Creating a new profile

- ▶ Select  **Create Profile** .
- ▶ Select an avatar.
- ▶ Enter the name and confirm with .
- ▶ Select **Continue** .
- ▶ Select **Current Settings**.
- ▶ Select **Save**.
- ▶ Activate Bluetooth® and select **Connect Phone**, to connect a mobile phone with the user profile.
- ▶ Select **Finished**.

Selecting profile options

- ▶ Select  for a profile. The following functions are available:
 - Resetting or deleting a profile
 - Resetting favorites
 - Configuring suggestions

Configuring suggestions

- ▶ Select  for a profile.
- ▶ Select **Suggestion Settings**.
- ▶ Switch **Allow Destination Suggestions**, **Allow Music Suggestions** and **Allow Contact Suggestions** on or off.
- ▶ **To deactivate the learning function for one day:** activate **Deact. Learning for 24 h**. For 24 hours no new actions will be trained and no data recorded for the active profile. Suggestions will continue to be shown. Example: if the option is switched on and a route to a new destination has been calculated, this destination would not be taken into account for the learning function.

System settings

Overview of the system settings menu

In the system settings menu, you can make settings in the following menus and control elements:

- Display
- Control elements:
 - Keyboard language and handwriting recognition
 - Sensitivity of the Touch Controls
- Voice Control System
- Sound:
 - Entertainment
 - Navigation and traffic announcements
 - Telephone
- Connectivity:
 - Transmission of the vehicle location
 - Wi-Fi, Bluetooth®, NFC
- Time & date
- Language
- Units for distance
- Software updates
- Data import and data export

- PIN protection
- System reset

Information on important system updates

Important system updates may be necessary for the security of your multimedia system's data. Install these updates, or else the security of your multimedia system cannot be ensured.

A system update consists of three steps:

- Downloading or copying of the data required for installation
 - Installation of the downloaded system update
 - Activation of the downloaded system update by restarting the system
- i** To use online updates, there must be an Internet connection. To use automatic online updates, your vehicle must have a permanently installed communication module.
- i** You can manually start the software update in the system settings. If automatic software updates are activated, the system updates will be downloaded automatically. Settings for automatic software updates can also be made in the system settings.

The multimedia system provides a message when a system update is available.

You have the following selection options:

- **Download**
The system update will be downloaded in the background.
- **Details**
Information about the pending system update is displayed.
- **Later**
The system update can be downloaded manually at a later time.

Deep system updates

Deep system updates access vehicle or system settings and can therefore only be carried out when the vehicle is stationary and the ignition is switched off.

If the download of a deep system update is complete and the downloaded system update is ready for installation, you will be informed of this after the vehicle is switched off and back on, for example.

- i** Park the vehicle safely in a suitable location before starting the installation.

Requirements for the installation:

- The vehicle is switched off.
- Notes and warnings have been read and accepted.
- The electric parking brake is applied.

If all requirements have been fulfilled, the downloaded system update is installed. The multimedia system cannot be operated while the downloaded system update is being installed and vehicle functions are restricted.

If errors occur during the installation, the multimedia system automatically attempts to restore the previous version. If restoration of the previous version is not possible, a symbol appears on the media display. Consult a qualified specialist workshop to resolve the problem.

Setting up a Wi-Fi hotspot

Requirements:

- **To set up the Wi-Fi connection of the multimedia system with external hotspots:** there is no communication module installed.
- The device to be connected supports at least one of the types of connection described.

Multimedia system:

 Settings >> System
>> Wi-Fi & Bluetooth

Activating/deactivating Wi-Fi

- ▶ Select **Wi-Fi**.

Connecting the multimedia system to an external hotspot via Wi-Fi

- i** The connection procedure may differ depending on the device. Follow the instructions that are shown in the display. Further information can be found in the manufacturer's operating instructions.
- ▶ Select **Internet Settings**.
 - ▶ Select **Connect via Wi-Fi**.
 - ▶ Select **Add Hotspot**.
 - ▶ Select the type of connection to be established on the multimedia system and on the device to be connected.

Connecting using a security key

- ▶ Select the options  of the desired Wi-Fi network.
- ▶ Select **Connect Using Security Key**.

- ▶ Have the security key displayed on the device to be connected (see the manufacturer's operating instructions).
- ▶ Enter this security key on the multimedia system.
- ▶ Confirm the entry with **ok**.

Activating automatic connection

- ▶ Select **Connect via Wi-Fi**.
- ▶ Select the options  of the desired Wi-Fi network.
- ▶ Activate **Permanent Internet Connection**.

Connecting with a known Wi-Fi network

- ▶ Select **Connect via Wi-Fi**.
- ▶ Select a Wi-Fi network.
The connection is established again.

Configuring the multimedia system as a Wi-Fi hotspot for external devices

The type of connection established depends on the device to be connected. The function must be supported by the multimedia system and by the device to be connected.

- ▶ Select **Vehicle Hotspot**.
- ▶ Select **Connect Device to Vehicle Hotspot**.
- ▶ Select the type of connection to be established on the multimedia system and on the device to be connected.

 Additional data volume is required for the "Internet in the Car" service and the associated use of web browsers, Internet Radio or the Wi-Fi hotspot, for example. This can be purchased directly from the mobile phone network provider.

Connecting using a security key

- ▶ Select **Connect Device to Vehicle Hotspot**.
A security key is displayed.
- ▶ Select the vehicle from the device to be connected. The vehicle is displayed with the **DIRECT-MBUX XXXXX** network name.
- ▶ Enter the security key which is shown in the media display on the device to be connected.
- ▶ Confirm the entry.

Connecting using NFC

- ▶ Select **Connect via NFC**.
- ▶ Activate NFC on the mobile device (see the manufacturer's operating instructions).

- ▶ Hold the device to be connected at the vehicle's NFC interface.
- ▶ Select **Finished**.
The mobile device is now connected to the multimedia system hotspot via NFC.

Generating a new security key

- ▶ Select **Vehicle Hotspot**.
- ▶ Select **Generate Security Key**.
- ▶ Select **New security key**.
A connection will be established with the newly created security key.
- ▶ **To save a security key:** select **Save**.
When a new security key is saved, all existing Wi-Fi connections are then disconnected. If the Wi-Fi connections are being re-established, the new security key must be entered.

System language

Notes on the system language

This function allows you to determine the language for the menus and the navigation announcements. The selected language affects the characters available for entry. The navigation announcements are not available in all languages. If a language is not available, the navigation announcements will be in English.

Setting the system language

Multimedia system:

  **Settings**  **System**
 **Language**

- ▶ Set the language.
-  If you are using Arabic map data, the text information can also be shown in Arabic on the navigation map. To do so, select **العربية** as the language from the language list. Navigation announcements are then also made in Arabic.

Resetting the multimedia system (reset function)

 **WARNING** Risk of accidents due to failure of multimedia display functions

While the multimedia system is being reset, its functions such as the rear view camera are not available.

- ▶ Only reset the multimedia system when the vehicle is stationary.

Multimedia system:

  **Settings**  **System**  **Reset**

Personal data is deleted, for example:

- Station presets
- Connected mobile phones
- Individual user profiles

 The guest profile is reset when the system is reset to the factory settings.

A prompt appears again asking whether you really want to reset the system.

 Select **Yes**.

If PIN protection is active, a prompt appears asking whether this too should be reset when the system is reset to the factory settings.

 Select variant 1: **Yes**.

 Enter the current PIN.
The PIN is reset.



 Select variant 2: **No**.
The current PIN is kept after reset.

 If you have forgotten your PIN you can have the PIN protection deactivated by an authorized Mercedes-Benz Center.

A prompt appears again asking whether you really wish to reset.

 Select **Yes**.
The multimedia system is reset to its state at delivery.

Resetting using buttons

 Simultaneously press and hold buttons **TEL** and  until the multimedia system restarts (at least 15 seconds).
The multimedia system is restarted. No data is deleted during this process.

Navigation

Switching on navigation

Multimedia system:

  **Navigation**

 Alternatively: press the **NAVI** button.
The map shows the current vehicle location.
The navigation menu is shown.

The navigation menu is hidden if route guidance is active.

 **To show:** tap on the touchscreen.

 **To hide:** the menu is hidden automatically.

Navigation overview



Example: digital map with navigation menu

- ① To enter a POI or address and additional destination entry options
 - ② To interrupt route guidance (if route guidance is active)
 - ③ To repeat a navigation announcement and switch navigation announcements on or off
 - ④ To call up the **ON THE WAY** menu
 - To show **Route Overview**
 - To select **Alternative Routes**
 - **Report Traffic Incident** (Car-to-X)
 - To call up the **TRAFFIC** menu
 - To show **Traffic Announcements**
 - To show **Area Alerts**
 - ⑤ Quick-access and settings
 - To show **Live Traffic Subscription Info**
 - To show **Route List**
 - To call up the **POSITION** menu
 - **Save Position**
 - To show **Compass**
 - To show **Traffic**
 - To show **Highway Information**
 - Via **Advanced** options to use **View, Announcements** and **Route**
- ① Some options are not available in all countries.

Entering a destination

Multimedia system:

→ 🏠 ▶▶ Navigation ▶▶ 🔍 Where to?



- ① Federal state or province in which the vehicle is located
 - ② To enter a POI or address
Underneath: Multimedia system suggestions during destination entry
During input: delete the entry with
 - ③ List with additional destination entry options
During destination entry: select search result
 - ④ To delete entered character
 - ⑤ To confirm an entry
 - ⑥ To call up handwriting recognition
 - ⑦ To enter a space
 - ⑧ To activate voice input
 - ⑨ To set the written language
 - ⑩ To switch to numbers, special characters and symbols
 - ⑪ To switch to upper-case or lower-case letters
- ▶ Enter the destination in ②. The entries can be made in any order.

The following entries can be made, for example:

- City, street, house number
- Street, city
- ZIP code
- POI name or POI category
- Contact name

- ▶ Select a search result in list ③.
- ▶ Calculate the route (→ page 199).

- ① You can find further information about destination entry, e.g. three-word addresses, in the Digital Operator's Manual.

Changing the country

- ▶ Select the indicator for federal state or province ①.
- ▶ Select the federal state or the province in ①.
- ▶ Enter the country indicator.
- ▶ Select the country on list ③.
- ▶ Select the federal state or the province from list ③.

Using online search

- ① Requirements:
 - Internet is connected (symbol in the status bar).
 - Mercedes me connect is available.
 - You have a user account for the Mercedes me Portal.
 - The vehicle is linked to the user account and you have accepted the terms of use for the Mercedes me connect services.
 - The navigation services are available and have been activated.

- ① Online search is not available in all countries. Destination entry uses online map services. If the on-board search finds no suitable destinations or if

you change countries, the online search is available.

For the destination you can enter an address, a POI or a three-word address.

- ▶ Select country indicator ①.
- ▶ Select the provider for the online service from the countries list.
- ▶ Enter the destination in ②.
The search results are displayed.
- ▶ Select the destination in list ③.
The detailed view for the route is displayed.

or

- ▶ Enter the destination in ②.
The search results are displayed.
- ▶ Select the destination in list ③.
The detailed view for the route is displayed.

Calculating a route and using settings for route guidance

Requirements:

- The destination has been entered.
- The destination address is shown.
- **For the commuter route:**
 - You have created a profile (→ page 193).
 - The **Allow Destination Suggestions** option is switched on .
 - The **Activate Commuter Route** option is switched on .
 - The multimedia system has gathered sufficient data in order to show destination suggestions.
 - Routes have been learned for these destination suggestions.

Multimedia system:

▶ ▶ Navigation

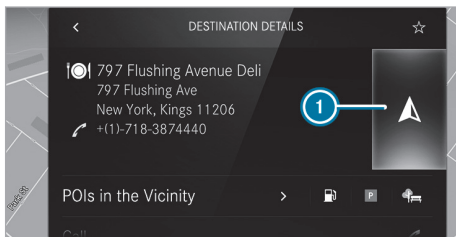

- ① No route yet.
- A route has been mapped.

- ▶ Select .
The route to the destination is calculated.
Route guidance begins.

or

- ▶ Select .
- ▶ Select **Set as Waypoint**.
The destination address is set as the next intermediate destination.

or

- ▶ Select **Start New Route Guidance**.
The destination address is set as the new destination. The previous destination and the intermediate destinations are deleted. Route guidance to the new destination begins.

Selecting route settings

- ▶ Select .
- ▶ Select **Advanced**.
- ▶ Select **Route**.
- ▶ Select the route type.
- ▶ Take traffic information into consideration with **Dynamic Route Guidance** .
- ▶ Selecting route options with **Avoid Options**.
- ▶ Activate **Alternative Routes**.
Alternative routes are calculated for every route.
- ▶ Activate **Activate Commuter Route**.
If the requirements for a commuter route are met, the multimedia system automatically detects that the vehicle is on a commuter route. Route guidance begins without voice output.

Using map functions

Multimedia system:

▶ ▶ Navigation

Increasing map scale

- ▶ When the map is shown, tap twice quickly with one finger on the media display.

or

- ▶ Move two fingers apart on the media display.

Decreasing map scale

- ▶ Tap with two fingers on the media display.

or

- ▶ Move two fingers together on the media display.

Moving the map

- ▶ Move one finger in any direction on the touchscreen.
- ▶ **To reset the map to the current vehicle position:** tap  briefly.

Selecting map orientation

- ▶ Tap repeatedly on the  compass symbol on the map.
The view changes in the sequence **3D, 2D Heading Up** to **2D North Up**.

Activating or deactivating freeway information

- ▶ Select .
- ▶ Activate or deactivate **Highway Information**.

Using Mercedes me connect services

Requirements:

- There is an Internet connection. The  symbol appears in the status line of the media display.
- Mercedes me connect is available.
- You have a user account for the Mercedes me Portal.
- The vehicle is connected with the user account and you have accepted the terms of use for the navigation services.

If Mercedes me connect is active, the  symbol is shown, for example, in the status line of the media display.

If the transfer of the vehicle position is activated, the  symbol appears.

Further information can be found at: <https://www.mercedes.me>

- The Mercedes me connect service is available.
- The Mercedes me connect service has been activated at an Mercedes-Benz .

Multimedia system:

  **▶▶ Navigation**

Displaying the traffic situation with Live Traffic Information

- ▶ Select .
- ▶ Activate **Traffic**.
- ▶ Select **Advanced**.
- ▶ Select **View**.
- ▶ Select **Map Elements**.

- ▶ Switch on **Traffic Incidents**, **Free Flowing Traffic** and **Delay**.

If traffic information has been received, traffic events are displayed, e.g. road works, road closures and warning messages.

The traffic delay is displayed for the current route. Traffic delays lasting a period of one minute or longer are taken into consideration.

Displaying hazard warnings with Car-to-X-Communication

If hazard warnings are available these are shown as symbols on the map. The display depends on the settings for the **Traffic** and **Traffic Incidents** options.

- ▶ Set the options.
If **Traffic** is switched off and **Traffic Incidents** is switched on, the symbols are shown on the prospective route.

Displaying weather information and other map contents

- ▶  The Navigation Plus service is available and has been booked. The Weather service is activated.

- ▶ Select .
- ▶ Select **Advanced**.
- ▶ Select **View**.
- ▶ Select **Map Elements**.
- ▶ Scroll up until the **ONLINE MAP CONTENT** category appears.
- ▶ Switch on a service, e.g. **Weather**.
Current weather information is displayed on the navigation map, e.g. temperature or cloud cover.

Parking service

! **NOTE** Damage to the vehicle due to not observing the maximum permitted headroom clearance

If the vehicle height is greater than the maximum permitted headroom clearance, the roof and other parts of the vehicle may be damaged.

- ▶ Observe the signposted headroom clearance.
- ▶ If the vehicle height is greater than the permitted headroom clearance, do not enter.

- ▶ Observe the changed vehicle height with add-on roof equipment.

! **NOTE** Vehicle damage due to failure to observe local information and parking conditions

The data is based on the information provided by the respective service providers.

Mercedes-Benz does not guarantee the accuracy of the information provided in relation to the car park or parking area.

- ▶ Always observe the local information and conditions.

i The Navigation Plus service is available and has been booked. The Parking service is activated.

i This service is not available in all countries.

▶ Tap on **P** on the map.

▶ Select a parking option.
The map shows the parking options in the vicinity.

The following information is displayed (if available):

- Destination address, distance from current vehicle position and arrival time
- Information on the parking garage/car park, for example:
 - Opening times
 - Parking charges
 - Current occupancy
 - Maximum parking time
 - **Maximum clearance height**

The maximum clearance height shown by the parking service does not replace the need for observation of the actual circumstances.

- Available payment options (Mercedes pay, coins, bank notes, cards)
- Details on parking tariffs
- Number of available parking spaces
- Payment method (e.g. at parking meters)
- Services/facilities at the parking option
- Telephone number

Telephone

Telephony

Notes on telephony

! **WARNING** Risk of distraction from operating integrated communication equipment while the vehicle is in motion

If you operate communication equipment integrated in the vehicle when driving, you could be distracted from the traffic situation. This could also cause you to lose control of the vehicle.

- ▶ Only operate this equipment when the traffic situation permits.
- ▶ If you cannot be sure of this, stop the vehicle whilst paying attention to road and traffic conditions and operate the equipment with the vehicle stationary.

! **WARNING** Risk of accident from operating mobile communication equipment while the vehicle is in motion

Mobile communication devices distract the driver from the traffic situation. This can also cause the driver to lose control of the vehicle.

- ▶ As a driver, only operate mobile communication devices when the vehicle is stationary.
- ▶ As a vehicle occupant, use mobile communication devices only in the designated area, e.g. in the rear passenger compartment.

You must observe the legal requirements for the country in which you are currently driving when operating mobile communication equipment in the vehicle.

Bluetooth® connection:

The menu view and the available functions in the phone menu are partly dependent on the Bluetooth® profile of the mobile phone connected.

If the mobile phone supports these Bluetooth® profiles, the full range of features is available:

- PBAP (Phone Book Access Profile)
 - The mobile phone's contacts are automatically displayed on the multimedia system.
- MAP (Message Access Profile)
 - The message functions of the mobile phone can be used on the multimedia system.

Irrespective of this, Bluetooth® audio functionality can be used with any mobile device.

For information on the functionality of the mobile device to be connected, see the manufacturer's operating instructions.

Network connection:

In the following cases, calls may be interrupted while driving:

- there is insufficient network coverage in the area.
- you switch to a transmitting/receiving station in which no communication channel is free.
- the SIM card used is not compatible with the network available.
- a mobile phone with "Twincard" is logged into the network with the second SIM card at the same time.

The multimedia system supports calls in HD Voice® for improved speech quality. A requirement for this is that the mobile phone and the mobile phone network provider of the person you are calling support HD Voice®.

Depending on the quality of the connection, the voice quality may fluctuate.

Further information can be obtained from an authorized Mercedes-Benz Center or at: <https://www.mercedes-benz-mobile.com/>

Telephone menu overview

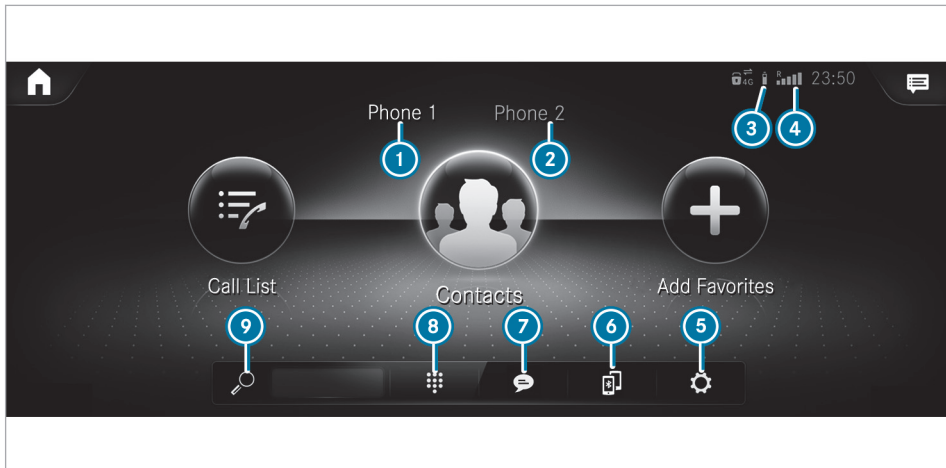

- 1 Bluetooth® device name of the currently connected mobile phone/the mobile phones
- 2 Bluetooth® device name of the currently connected mobile phone/the mobile phones (two phone mode)
- 3 Battery status of the connected mobile phone
- 4 Signal strength of the mobile phone network
- 5 Options
- 6 Device manager
- 7 Messages
- 8 Numerical pad
- 9 Contact search

Telephony operating modes overview

Depending on the equipment, the following telephone operating modes are available:

- One mobile phone is connected to the multimedia system via Bluetooth®.
- Two mobile phones are connected with the multimedia system via Bluetooth® (two phone mode).
 - You can use all the functions of the multimedia system with the mobile phone in the foreground.
 - You can receive incoming calls and messages with the mobile phone in the background.

You can interchange the mobile phone in the foreground and background.

Connecting a mobile phone

Requirements:

- Bluetooth® is activated on the mobile phone (see the manufacturer's operating instructions).
- Bluetooth® is activated on the multimedia system.

Multimedia system:

→ [Home] → Phone

Searching for a mobile phone

- ▶ Select [Phone].
- ▶ Select **Connect New Device**.



Connecting a mobile phone

Authorization takes place using secure simple pairing.

- ▶ Select a mobile phone.
A code is displayed in the multimedia system and on the mobile phone.
- ▶ If both codes match, confirm the code on the mobile phone.

Functions in the Telephony menu

The functions available in the Telephony menu include the following:

- Making calls, e.g.:
 -  Accepting a call
 -  **End Call**
 -  **Create Confer. Call**
 - Accepting or rejecting a waiting call
- Managing contacts, e.g.:
 - Downloading mobile phone contacts
 - Editing the format of a contact's name
 - Saving contacts in the vehicle
- Receiving and sending messages, e.g.:
 - Using the read-aloud function
 - Dictating a new message

Overview of Smartphone Integration

With Smartphone Integration, you can use certain functions on your mobile phone via the multimedia system display.



Only one mobile phone at a time can be connected via Smartphone Integration to the multimedia system. Also for use with two phone mode with smartphone integration, only one additional mobile phone can be connected using Bluetooth® with the multimedia system.

The full range of functions for Smartphone Integration is only possible with an Internet connection. The appropriate application must be downloaded on the mobile phone to use Smartphone Integration. The mobile phone must be switched on and connected to a USB port with the  symbol on the multimedia system using a suitable cable.

Apps for Smartphone Integration

- Apple CarPlay®
- Android Auto

You can start Apple CarPlay® or Android Auto using the **Apps** menu.

Alternative: If an application is active via Smartphone Integration (e.g. when music is being played or route guidance is active), you can call up the active application using the ,  or  application buttons.

You can end Smartphone Integration by disconnecting the connecting cable between the mobile phone and multimedia system.

- ① Mercedes-Benz recommends disconnecting the connecting cable only when the vehicle is stationary.

When using Android Auto or Apple CarPlay®, certain vehicle data is transferred to the mobile phone. This enables you to get the best out of selected mobile phone services. Vehicle data is not directly accessible.

The following system information is transmitted:

- Software release of the multimedia system
- System ID (anonymized)

The transfer of this data is used to optimize communication between the vehicle and the mobile phone.

To do this, and to assign several vehicles to the mobile phone, a vehicle identifier is randomly generated.

This has no connection to the vehicle identification number (VIN) and is deleted when the multimedia system is reset (→ page 195).

The following vehicle status data is transmitted:

- The gear engaged
- The distinction between parked, standstill, rolling and driving
- The day/night mode of the instrument cluster

The transfer of this data is used to alter how content is displayed to correspond to the driving situation.

The following position data is transmitted:

- Coordinates
- Speed
- Compass direction
- Acceleration direction

This data is only transferred while the navigation system is active, in order to improve it (e.g. so it can continue functioning when in a tunnel).

Web browser overview

The web browser is launched on the home screen after selecting **Apps** via  **Browser**.

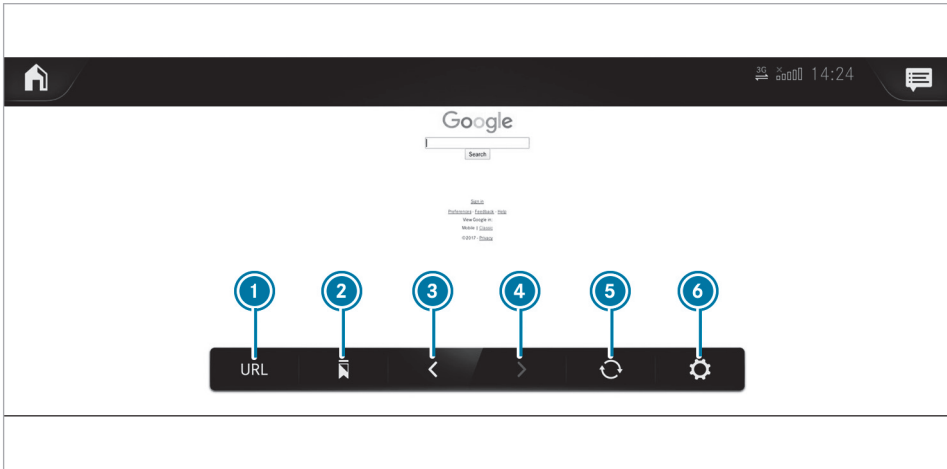









- ① URL entry
- ② Bookmarks
- ③ Previous website
- ④ Next website
- ⑤ Refresh/stop
- ⑥ Options
- ⓘ Some functions are country-dependent.
- ⓘ Websites cannot be shown while the vehicle is in motion.
- ⓘ Additional data volume is required for the use of the web browser. Via the "Internet in the Car" service you can purchase this data volume for a fee **directly from the mobile phone network provider Vodafone**.

Radio and media

Overview of the symbols and functions in the media menu

Symbol	Designation	Function
	Play	Select to start or continue playback.
	Pause	Select to pause the playback.
	Repeat track	Select to repeat the current track or the active playlist. <ul style="list-style-type: none"> • Select once: the active playlist is repeated. • Select twice: the current track is repeated. • Select three times: the function is deactivated.

Symbol	Designation	Function
	Random playback	Select to play back the tracks in random order.
	Back/forward	Select to skip to the previous or to the next track.
	Options	Select to show additional options.
	Categories	Select to show or search through available categories (e.g. playback lists, albums, artists, etc.).
	Search	Select to search in the active menu. You can search for artists or genres, for example.
	Settings	Select to make settings.
	Home	Select to return to the home screen.
	Full screen	Select to switch to full screen mode.

The following functions and settings are available in the media menu:

- Connecting external data storage media with the multimedia system (e.g. using USB or Bluetooth®)
- Playing back audio or video files

Authorizing Bluetooth® audio equipment for media playback

Requirements:

- Bluetooth® is activated on the multimedia system and audio equipment .
- The audio equipment supports the Bluetooth® audio profiles A2DP and AVRCP.
- The audio equipment is "visible" for other devices.

Multimedia system:



Using Bluetooth® Audio, you can play back music files via the MBUX multimedia system from an external data storage medium, e.g. your smartphone.

- ▶ To play back audio files using the multimedia system, authorize the external data storage medium on the MBUX multimedia system.









Authorizing a new Bluetooth® audio device

- ▶ Select **Connect New Device**.
- ▶ Select an audio device. Authorization starts. A code is displayed on the multimedia system and on the mobile phone.
- ▶ If the codes are identical, confirm on the audio equipment.
- ▶ Select **Only as Bluetooth Audio Device**. The Bluetooth® audio equipment is connected with the multimedia system.

Connecting previously authorized Bluetooth® audio equipment

- ▶ Select a Bluetooth® audio device from the list. The connection is established.

Overview of the symbols and functions in the radio menu



Symbol	Designation	Function
	Home	Select to return to the home screen.
	Messaging	Select to call up messaging.
	Back/forward	Select to skip to the previous or to the next station.
	Settings	Select to show further options. Settings can be made to the following additional functions, for example: <ul style="list-style-type: none"> • Navigation and traffic announcements • Frequency fix function • Radio additional text • Emergency warnings The setting options are country-dependent.
HD	HD Radio®	Select to switch the HD Radio® function on or off. This function is not available in all countries.
	Mute function	Select to switch off the sound.
	Storing radio stations	Select to save a radio station in the station list.
	Station list	Select to display the station list.
	Search	Select to browse the active menu, for example, by artist or genre.



Depending on the frequency band selected, different functions are available to you.

Select the desired frequency band in the radio menu head runner.

Additional functions of Tuneln Radio

-  A relatively large volume of data can be transmitted when using Tuneln Radio.

Symbol	Designation	Function
	Settings	The following additional settings are available in the Tuneln Radio menu: <ul style="list-style-type: none"> • Selecting stream • Logging on to or out of the Tuneln account
	Favorites	Select during playback to save the station currently set as a favorite.





Symbol	Designation	Function
	Play/Pause	Select to start, stop or continue playback.
	Browse	Select to choose a category and then a radio station.

Additional functions of the satellite radio

SIRIUS XM® satellite radio offers more than 175 digital-quality radio channels providing 100 % commercial-free music, sports, news and entertainment, for example. SIRIUS XM® satellite radio employs a fleet of high-performance satellites to broadcast around the clock throughout the USA and Canada. The satellite radio program is available for a monthly fee. Information about this can

be obtained from a Sirius XM® Service Center and at <https://www.siriusxm.com> (USA) or <https://www.siriusxm.ca> (Canada).

-  Sirius, XM and all related marks and logos are trademarks of Sirius XM Radio Inc. and its subsidiaries. All other marks, channel names and logos are the property of their respective owners. All rights reserved.

Symbol	Designation	Function
	Settings	The following additional settings are available in the satellite radio menu: <ul style="list-style-type: none"> • Activate child safety lock to lock channels with adult content • Set alarm program for music and sport alerts • Create TuneMix lists to listen to music seamlessly
	Playback control	Select to show the timeline. Tap any point on the timeline to skip forwards or back. Navigate to the end of the timeline to return to live mode.
	Play	Select to start or continue playback.
	Pause	Select to pause the playback.

Sound settings

Overview of functions in the Sound menu

The sound system is available for all functions in the radio and media modes. The settings, for example for the equalizer, affect the playback of all media sources.

The following functions are available:

- Equalizer
 - Treble, mid-range and bass
- Balance and fader
- Volume
 - Automatic volume adjustment

Notes on loading guidelines

⚠ DANGER Risk of poisoning from exhaust gases

Combustion engines emit poisonous exhaust gases, such as carbon monoxide. Exhaust gases can enter the vehicle interior if the rear-end door is open when the engine is running, especially if the vehicle is in motion.

- ▶ Always switch off the engine before opening the rear-end door.
- ▶ Never drive with the rear-end door open.

⚠ WARNING Risk of injury from unsecured objects in the vehicle

When objects are unsecured or inadequately secured, they can slip, tip over or be thrown about, striking vehicle occupants.

This also applies to:

- Luggage or loads
- Seats which have been removed and are being transported in the vehicle in an exceptional case

There is a risk of injury, particularly in the event of braking maneuvers or abrupt changes in direction.

- ▶ Always stow objects in such a way that they cannot be tossed about.
- ▶ Before traveling, secure objects, luggage or load to prevent them slipping or tipping over.
- ▶ When a seat is removed, keep it preferably outside the vehicle.

⚠ WARNING Risk of injury due to objects being stowed incorrectly

If objects in the vehicle interior are stowed incorrectly, they can slide or be thrown around and hit vehicle occupants. In addition, cup holders, open storage spaces and mobile phone receptacles cannot always retain all objects within.

There is a risk of injury, particularly in the event of sudden braking or abrupt changes in direction.

- ▶ Always store objects such that they cannot be thrown around in such situations.

- ▶ Always make sure that objects do not protrude from storage spaces, parcel nets or storage nets.
- ▶ Close the lockable storage spaces before starting a journey.
- ▶ Stow and secure objects that are heavy, hard, pointed, sharp-edged, fragile or too large in the cargo compartment.

⚠ WARNING Risk of burns from the tailpipe and tailpipe trims

The exhaust tailpipe and tailpipe trims can become very hot. If you come into contact with these parts of the vehicle, you could burn yourself.

- ▶ Always be particularly careful around the tailpipe and the tailpipe trims and supervise children especially closely in this area.
- ▶ Allow vehicle parts to cool down before touching them.

If you are using a roof luggage rack, please note the maximum roof load and the maximum load capacity of the roof luggage rack. (→ page 284)

Camera-based driving systems and the sensor functions of the inside rear-view mirror may be impaired if you are transporting a load on the roof and it protrudes more than 16 in (40 cm) over the front edge of the roof. Therefore, make sure that the load does not protrude by more than 16 in (40 cm).

The handling characteristics of your vehicle are dependent on the load distribution.

Therefore, please observe the following notes when loading:

- When transporting a load, never exceed the gross vehicle weight rating or the gross axle weight rating for the vehicle (including occupants). The figures are specified on the vehicle identification plate on the B-pillar.
- The load must not protrude above the upper edge of the seat backrests.
- If possible, always transport the load in the cargo compartment.
- Fasten the load to the cargo tie down rings and distribute the load evenly among them.
- Use cargo tie down rings and fastening materials that are suitable for the weight and size of the load.

Notes on distributing the load within the vehicle

! NOTE Risk of damage to the floor covering

Excessive point loading on the cargo compartment floor or on the load area can negatively affect the driving characteristics and could damage the floor covering.

▶ **Vehicles with rear-wheel drive:** distribute the load uniformly. When doing so, ensure that the overall center of gravity of the load is always as low and close to the center as possible and between the axles near the rear axle.

▶ **Vehicles with all-wheel drive:** distribute the load uniformly. When doing so, ensure that the overall center of gravity of the load is always as low and close to the center as possible and between the axles.

For panel vans, buses and crewbuses:

- always transport loads in the cargo compartment.
- always place the load against the seat backrests of the rear bench seat.
- move large and heavy loads as far towards the front of the vehicle as possible, against the rear bench seat. stow loads flush behind the rear bench seat.
- always additionally secure the load with suitable load securing aids or lashing material.
- the load must not protrude above the upper edge of the seat backrests.
- transport loads behind seats that are not occupied.
- If the rear bench seat is not occupied, insert the seat belts crosswise into the seat belt buckle of the opposite seat belt.

Securing loads

Notes on load securing

! WARNING Risk of accident and injury due to incorrect use of the lashing straps

The following can occur:

- The tie-down eyes may detach or the lashing strap may tear if the permissible load is exceeded
- The load cannot be restrained

The load can slip, tip over or be flung about, striking vehicle occupants.

- ▶ Always tension the lashing straps in the proper manner and only between the described tie-down eyes.
- ▶ Always use lashing straps designed specifically for the loads.

- i** Observe the information relating to the maximum loading capacity of the individual cargo tie-down points. If you combine various cargo tie-down points to secure a load, always take the maximum loading capacity of the weakest cargo tie-down point into account. During maximum full-stop braking, forces may act which can multiply the weight of the load. Always use several cargo tie-down points to distribute the load. Spread the load evenly between the cargo tie-down points or tie-down eyes.

Observe the Operating Instructions or the lashing strap manufacturer's instructions for the operation of the lashing strap.

Observe the information relating to the maximum loading capacity of the cargo tie-down points (→ page 283).

As the driver, you are responsible for ensuring the following:

- The load is secured against slipping, tipping, rolling or falling off.
Take usual traffic conditions as well as swerving or full brake application and bad roads into account.
- The applicable requirements and guidelines relating to load-securing practices are met.
If this is not the case, this may constitute a punishable offense, depending on local legislation and any ensuing consequences. Observe country-specific laws.

Make sure that the load is secure before every journey and at regular intervals during a long journey. Adjust the load securing as necessary. Information on how to secure loads correctly can be obtained from the manufacturers of the load securing aids or tie downs for load securing, for example.

When securing loads, observe the following:

- Fill spaces between the load and the cargo compartment walls or wheel wells. For this purpose, use rigid load securing aids, such as chocks, wooden fixings or padding.
- Attach secured and stabilized loads in all directions.

Use the cargo tie-down points or tie-down eyes and the loading rails in the cargo compartment.

Only use tie downs, such as lashing rods, lock rods or lashing nets and lashing straps, which have been tested in accordance with current standards (e.g. DIN EN). Always use the cargo tie-down points closest to the load and pad sharp edges.

Loads, and heavy loads in particular, should preferably be secured using the tie-down eyes.

- ❗ You can obtain tie downs tested in accordance with current standards (e.g. DIN EN) from any specialist company or from a qualified specialist workshop.

Notes on the partition

Without a partition, vehicles that are approved as commercial vehicles (vehicle category N1, N2) do not fulfill standard ISO 27956, which describes the equipment for properly securing a load in delivery vehicles. If the vehicle is used to transport goods, retrofitting the partition is strongly recommended, as properly securing the load in vehicles without a partition will always be a complex operation.

- ❗ Nothing may be stowed in the area between the rear side of the seats and the partition.

Overview of cargo tie-down point

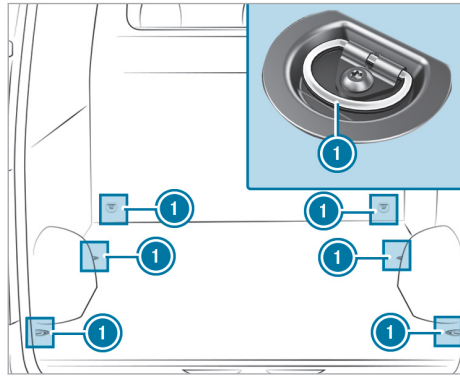

Cargo tie-down points (example: cargo van without loading rails)

- ❶ Cargo tie-down rings

Secure loose loads with an approved lashing net or a tarp.

Always fasten the lashing net or tarp to all available cargo tie-down points. Make sure that the fastening hooks are secured against accidental opening.

If your vehicle is equipped with loading rails in the cargo floor, you can place lashing rods directly in front of and behind the load. The lashing rods directly absorb the potential shifting forces.

Securing loads on the cargo floor by lashing them down is recommended only for lightweight loads. Lay anti-slip mats under the load to assist in securing it.

Installing and removing cargo tie-down rings

► **To install:** slide the cargo tie-down ring through a recess in the loading rail close to the load until the locking mechanism engages in the recess.

- ❗ When you pull the locking mechanism up and out of the recess, the cargo tie-down ring is able to move within the loading rail. Make sure that the locking mechanism is always engaged in a recess.

► Check the cargo tie-down ring for firm seating.

► **To remove:** pull the locking mechanism up and pull the cargo tie-down ring towards the locking mechanism and out of the loading rail through a recess.

Carrier systems

Information on the roof luggage rack

⚠ WARNING Risk of injury if maximum roof load is exceeded

The vehicle center of gravity and the usual driving characteristics as well as the steering and braking characteristics will change.

If you exceed the maximum roof load, the handling as well as steering and braking characteristics are severely affected.

▶ Always comply with the maximum roof load and adjust your driving style.

! NOTE Vehicle damage due to failure to observe the maximum permissible clearance height

If the vehicle height exceeds the maximum permissible clearance height, the roof and other vehicle parts may be damaged.

- ▶ Please observe the maximum clearance height indicated.
- ▶ If the vehicle exceeds the permissible clearance height, do not drive in.
- ▶ Take the modified vehicle height into account in the case of roof superstructures or other carrier systems.

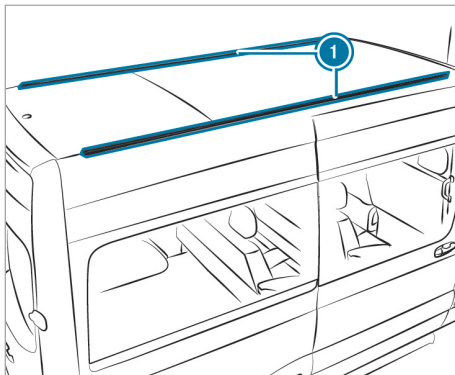

① Mounting rails

Information about the maximum roof load can be found in the "Technical data" section (→ page 284).

Observe the following points for installing roof luggage racks:

- Tighten the screws of the roof luggage rack to a torque of 6.0 lb-ft (8 Nm) – 7.4 lb-ft (10 Nm) in the designated sliding blocks.
- The tightened screws should not touch the rails.
- Ensure that the sliding blocks are not located in the areas around the plastic caps.
- The sliding blocks must have the right cross-section.
- The insides of the mounting rails must be free of dirt.
- Re-tighten the screws uniformly after around 300 miles (500 km).

Mercedes-Benz recommends that you use only roof luggage racks that have been tested and approved for Mercedes-Benz. These will help to prevent vehicle damage.

Have mounting rails retrofitted only at a qualified specialist workshop. Otherwise, you could damage the vehicle.

If your vehicle is equipped with mounting rails on the roof, you can install a roof luggage rack on the roof. Special mounting elements (sliding blocks) are available as accessories for this purpose.

These mounting elements are available from any authorized Mercedes-Benz Center.

Placing a load on the wheel arch

Comply with the important safety notes under "Notes on loading" (→ page 209).

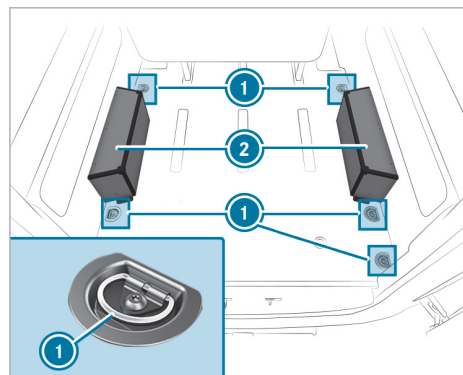

- ▶ Place the objects on wheel arch ② and lash them using tie-down eyes ① (→ page 211).

- ⓘ A wheel arch may be subjected to a load of 330 lb (150 kg).

ASSYST PLUS service interval display

Function of the ASSYST PLUS service interval display

The ASSYST PLUS service interval display on the instrument cluster provides information on the remaining time or distance before the next service due date.

You can hide this service message by using the back button on the left-hand side of the steering wheel.

You can obtain further information concerning the servicing of your vehicle from a qualified specialist workshop, e.g. an authorized Mercedes-Benz Center.

Displaying the service due date

On-board computer:

➔ Service ➔ ASSYST PLUS

The next service due date is displayed.

▶ **To exit the display:** press the back button on the left-hand side of the steering wheel.

Bear in mind the following related topic:

- Operating the on-board computer (→ page 177)

Have service work carried out regularly

! **NOTE** Premature wear through failure to observe service due dates

Maintenance work which is not carried out at the right time or incompletely can lead to increased wear and damage to the vehicle.

- ▶ Adhere to the prescribed service intervals.
- ▶ Always have the prescribed maintenance work carried out at a qualified specialist workshop.

Special service requirements

The prescribed service interval is based on normal vehicle use. Perform maintenance work more often than prescribed if the vehicle is operated under arduous operating conditions or increased loads.

Examples of arduous operating conditions:

- Regular city driving with frequent intermediate stops
- Mainly short-distance driving
- Frequent operation in mountainous terrain or on poor road surfaces
- When the engine is often left idling for long periods
- Operation in particularly dusty conditions and/or if air-recirculation mode is frequently used

In these or similar operating conditions, have the interior air filter, air filter, engine oil and oil filter, for example, changed more frequently. Check the tires more frequently if the vehicle is operated under increased stress. You can obtain further information at a qualified specialist workshop.

Non-operational times with the battery disconnected

The ASSYST PLUS service interval display can calculate the service due date only when the battery is connected.

▶ Display and note down the service due date on the instrument cluster before disconnecting the battery (→ page 214).

Engine compartment

Opening and closing the hood

! **WARNING** Risk of accident due to driving with the hood unlocked

The hood may open and block your view.

- ▶ Never release the hood when driving.
- ▶ Before every trip, ensure that the hood is locked.

! **WARNING** Risk of burns when opening the hood

If you open the hood in the event of an overheated engine or fire in the engine compartment, the following situations may occur:

- You may come into contact with hot gases.
- You may come into contact with other escaping hot operating fluids.

- ▶ Before opening the hood, allow the engine to cool down.
- ▶ In the event of a fire in the engine compartment, keep the hood closed and call the fire service.

⚠ WARNING Risk of injury due to moving parts

Components in the engine compartment can continue to run or start unexpectedly even when the ignition is switched off.

Observe the following before performing tasks in the engine compartment:

- ▶ Switch off the ignition.
- ▶ Never touch the danger zone surrounding moving components, e.g. the rotation area of the fan.
- ▶ Remove jewellery and watches.
- ▶ Keep items of clothing and hair away from moving parts.

⚠ WARNING Risk of injury from touching live components

The ignition system and the fuel injection system operate with a high voltage. You could receive an electric shock.

- ▶ Never touch components of the ignition system or fuel injection system when the vehicle is switched on.

Live components in the fuel injection system include the injectors, for example.

Live components of the ignition system include the following:

- Ignition coils
- Spark plug connectors
- Diagnostic socket

⚠ WARNING Risk of burns from hot component parts in the engine compartment

Certain component parts in the engine compartment can be very hot, e.g. the engine, the cooler and parts of the exhaust system.

- ▶ Allow the engine to cool down and only touch component parts described in the following.

If you have to carry out any work in the engine compartment, touch only the following component parts:

- Hood
- Engine oil filler opening cap
- Washer fluid reservoir cap
- Coolant expansion reservoir cap

⚠ WARNING Risk of injury from using the windshield wipers when the hood is open

If the windshield wipers start moving when the hood is open, you could be trapped by the wiper linkage.

- ▶ Always switch off the windshield wipers and vehicle before opening the hood.

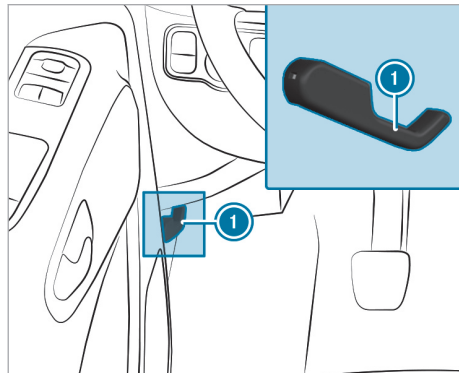

- ▶ Park the vehicle safely and on a surface that is as level as possible.
- ▶ Switch off the vehicle.
- ▶ Secure the vehicle against rolling away.

⚠ WARNING Risk of injury when the hood is opened

The hood may suddenly drop into the end position.

There is a risk of injury for anyone in the hood's range of movement.

- ▶ Before releasing the hood, ensure that the support is firmly seated in the holder.
- ▶ Open the hood only when there is no-one in its range of movement.

- ▶ **To open:** pull handle ① to release the hood.
- ▶ Reach into the gap and push the hood catch handle upwards.

- ▶ Open the hood and hold it up.

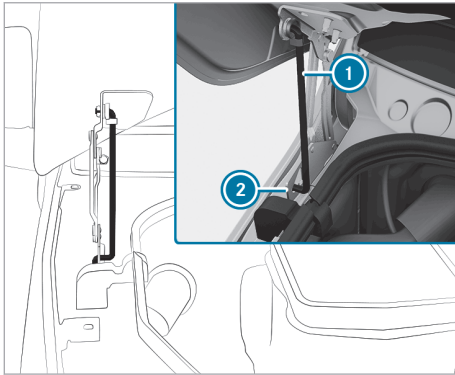

- ▶ Take support ① from the holder on the hood and pull it downwards.
- ▶ Insert the support into bracket below ②.

⚠ WARNING Risk of fire due to flammable materials in the engine compartment or on the exhaust system

Flammable materials may ignite.

- ▶ Ensure that there are no flammable external materials in the engine compartment or on the exhaust system after maintenance work has been carried out.

⚠ WARNING Risk of accident and injury when opening and closing the hood

The hood may suddenly drop into the end position.

There is a risk of injury for anyone in the hood's range of movement.

- ▶ Do not open or close the hood if there is a person in the hood's range of movement.

! NOTE Damage to the hood

Pushing the hood closed with your hands could damage it.

- ▶ To close the hood, let it drop from the specified height.

- ▶ **To close:** lift the hood slightly.
- ▶ Move support ① to the holder on the hood and apply light pressure to engage it.

- ▶ Lower the hood and let it drop from a height of approximately 0.5 ft (15 cm).
- ▶ If it is still possible to lift the hood a little, open the hood again and let it drop from a height of approximately 0.7 ft (20 cm) until it engages correctly.

Engine oil

■ Checking the engine oil level with the on-board computer

Requirements:

- The vehicle is level during the measuring process.
- The hood is closed.
- Depending on the driving profile, the oil level can be displayed only after a driving time of up to 30 minutes and only when the vehicle is switched on.

On-board computer:

➤ [Service](#) ➤ [Engine Oil Level](#)

One of the following messages appears on the instrument cluster:

- ▶ **Measuring Engine Oil Level...:** measurement of the oil level is not yet possible. Repeat the query after driving for a maximum of 30 minutes.
- ▶ **Engine Oil Level OK** and the bar indicating the oil level on the instrument cluster is green and is between "min" and "max": the oil level is correct.
- ▶ **Engine Oil Level Drive until the engine is warm.:** warm up the engine to operating temperature.
- ▶ **Engine Oil Level Correct Measurement Only if Vehicle Is on Level Ground:** park the vehicle on a level surface.
- ▶ **Engine Oil Level Refill 1,0 liq.gal.** and the bar indicating the oil level on the instrument cluster is orange and lies below "MIN": add 1.0 US qt (1 l) of engine oil.
- ▶ **Reduce Engine Oil Level** and the bar indicating the oil level on the instrument cluster is orange and lies above "MAX": drain off excess engine oil.
Consult a qualified specialist workshop.
- ▶ **For Engine Oil Level Switch Ignition On:** switch on the vehicle.

▶ **Engine Oil Level System Inoperative:** the sensor is defective or not connected. Consult a qualified specialist workshop.

▶ **Engine Oil Level System Currently Unavailable:** close the hood.

❗ **Vehicles with cold oil level displays:** the oil level will automatically be displayed on the instrument cluster after the vehicle has been non-operational for an extended period. If it is not possible to measure the engine oil level, a message to that effect will appear.

❗ The result of the electronic measurement always takes precedence over other measurements.

■ Topping up engine oil

⚠ WARNING Risk of burns from hot component parts in the engine compartment

Certain component parts in the engine compartment can be very hot, e.g. the engine, the cooler and parts of the exhaust system.

▶ Allow the engine to cool down and only touch component parts described in the following.

If you have to carry out any work in the engine compartment, touch only the following components:

- Hood
- Engine oil filler opening cap
- Washer fluid reservoir cap
- Coolant expansion reservoir cap

⚠ WARNING Risk of fire and injury from engine oil

If engine oil comes into contact with hot component parts in the engine compartment, it may ignite.

- ▶ Make sure that no engine oil is spilled next to the filler opening.
- ▶ Allow the engine to cool off and thoroughly clean the engine oil from component parts before starting the vehicle.

❗ **NOTE** Engine damage caused by an incorrect oil filter, incorrect oil or additives

▶ Do not use engine oils or oil filters other than those which meet the specifications

necessary for the prescribed service intervals.

Mercedes-Benz recommends using original or tested replacement and service parts.

- ▶ Do not alter the engine oil or oil filter in order to achieve longer change intervals than prescribed.
- ▶ Do not use additives.
- ▶ Follow the instructions on the service interval display regarding oil changes.

❗ **NOTE** Damage caused by adding too much engine oil

Excessive engine oil can damage the engine or the catalytic converter.

▶ Have excess engine oil removed in a qualified specialist workshop.

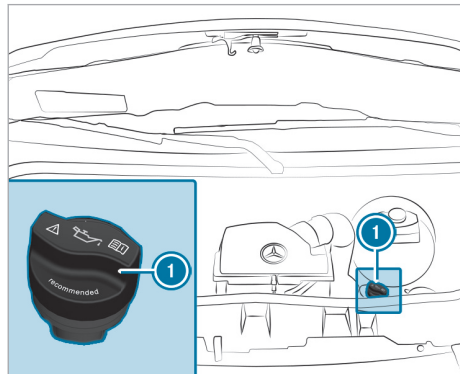

OM654 engine, rear-wheel and all-wheel drive

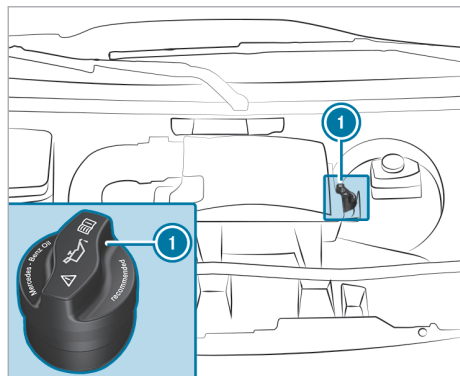

M274 engine

- ▶ Turn cap ❶ counter-clockwise and remove it.
- ▶ Top up the engine oil.
- ▶ Replace cap ❶ and turn it clockwise until it engages.
- ▶ Check the oil level again. Check using the on-board computer (→ page 216), check with the oil dipstick .
- ▶ If your vehicle has an engine that does not have an oil dipstick, check the oil level with the on-board computer after the next journey (→ page 216).

It is necessary to run the engine for an extended period after each oil top-up to correctly detect the oil level. Fill level changes during oil top-ups may not be immediately visible. Depending on the driving profile, the new oil level can be displayed only after a driving time of up to 60 minutes.

To avoid damage due to overfilling, do not add more than 0.26 gal (1 liter).

Check the oil level again after an extended period.

Checking the coolant level

If you have to carry out any work in the engine compartment, touch only the following components:

- Hood
- Engine oil filler opening cap
- Washer fluid reservoir cap
- Coolant expansion reservoir cap

⚠ WARNING Risk of scalding from hot coolant

You may scald yourself if you open the cap when the drive system is at normal operating temperature.

- ▶ Allow the drive system to cool down before opening the cap.
- ▶ When opening the cap, wear protective gloves and safety glasses.
- ▶ Open the cap slowly to release pressure.

Allow the engine and the engine cooling system to cool down before checking the coolant level or adding coolant.

The coolant temperature must be below 122°F (50°C).

! NOTE Paintwork damage due to coolant

If coolant gets on painted surfaces, the paintwork can be damaged.

- ▶ Add coolant carefully.
- ▶ Remove spilled coolant.

Checking the coolant level

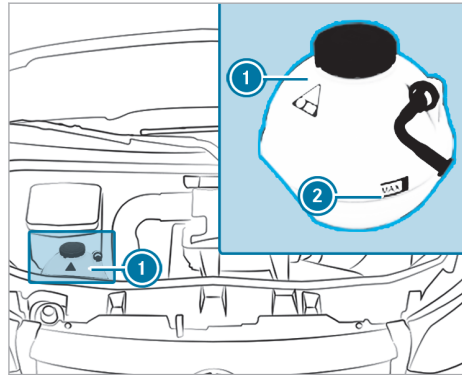

Coolant expansion reservoir (example)

- ▶ Park the vehicle on a level surface.
- ▶ Open the hood (→ page 214).
- ▶ Slowly turn coolant expansion reservoir cap ❶ half a turn counter-clockwise to release overpressure.
- ▶ Turn coolant expansion reservoir cap ❶ further and remove it.
- ▶ Check the coolant level. There is enough coolant in the coolant expansion reservoir if the coolant reaches lower MAX mark ❷.

Adding coolant

- ▶ Refill the coolant to lower MAX mark ❷ on the coolant expansion reservoir.

Use only coolant approved by Mercedes-Benz to avoid damaging the engine cooling system.

- ▶ Replace coolant expansion reservoir cap ❶ and tighten it in a clockwise direction.
- ▶ Start the vehicle.
- ▶ After about five minutes, switch off the vehicle again and allow it to cool down.
- ▶ Check the coolant level again and add coolant if necessary.

- ⓘ Observe additional coolant information (→ page 277).

Refilling the windshield washer system

If you have to carry out any work in the engine compartment, touch only the following components:

- Hood
- Engine oil filler opening cap
- Washer fluid reservoir cap
- Coolant expansion reservoir cap

⚠ WARNING Risk of burns when opening the hood

If you open the hood in the event of an overheated engine or fire in the engine compartment, the following situations may occur:

- You may come into contact with hot gases.
 - You may come into contact with other escaping hot operating fluids.
- ▶ Before opening the hood, allow the engine to cool down.
 - ▶ In the event of a fire in the engine compartment, keep the hood closed and call the fire service.

⚠ WARNING - Risk of fire and injury from windshield washer concentrate

Windshield washer concentrate is highly flammable. It could ignite if it comes into contact with hot engine component parts or the exhaust system.

- ▶ Make sure that no windshield washer concentrate spills out next to the filler opening.

! NOTE Damage to the exterior lighting due to unsuitable windshield washer fluid

Unsuitable windshield washer fluid may damage the plastic surface of the exterior lighting.

- ▶ Only use windshield washer fluids that are also suitable for use on plastic surfaces, e.g. MB SummerFit or MB WinterFit.

Adding washer fluid

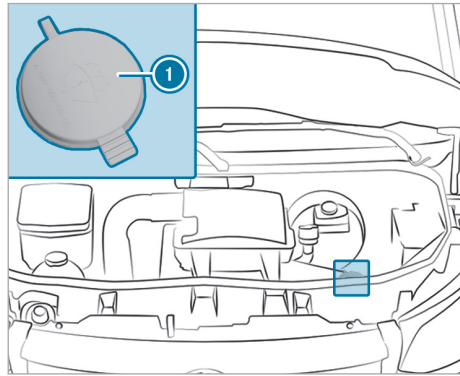

Washer fluid reservoir (example)

- ▶ Pre-mix the washer fluid in the correct mixing ratio in a container.
 - ▶ Park the vehicle on a level surface and secure it against rolling away (→ page 139).
 - ▶ Open the hood (→ page 214).
 - ▶ Pull cap ① of the washer fluid reservoir upwards by the tab.
 - ▶ Pour in the pre-mixed washer fluid.
 - ▶ Push cap ① onto the filler opening until it audibly engages.
 - ▶ Close the hood (→ page 214).
- ⓘ Mix the washer fluid with windshield washer concentrate all year round. Comply with the information about windshield washer fluid in the technical data (→ page 278).
 - ⓘ Comply with the further information about windshield washer fluid (→ page 278)

Cleaning the water drain valve of the air intake box

⚠ WARNING Risk of injury due to moving parts

Components in the engine compartment can continue to run or start unexpectedly even when the ignition is switched off.

Observe the following before performing tasks in the engine compartment:

- ▶ Switch off the ignition.
- ▶ Never touch the danger zone surrounding moving components, e.g. the rotation area of the fan.

- ▶ Remove jewellery and watches.
- ▶ Keep items of clothing and hair away from moving parts.

⚠ WARNING Risk of burns from hot component parts in the engine compartment

Certain component parts in the engine compartment can be very hot, e.g. the engine, the cooler and parts of the exhaust system.

- ▶ Allow the engine to cool down and only touch component parts described in the following.

If you have to carry out any work in the engine compartment, touch only the following components:

- Hood
- Engine oil filler opening cap
- Washer fluid reservoir cap
- Coolant expansion reservoir cap

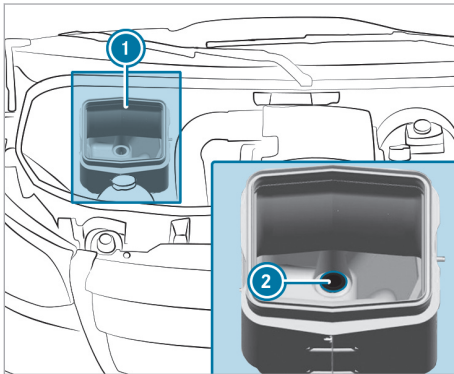

- ▶ Open the hood (→ page 214).
- ▶ Remove dirt from water drain valve (2) of air intake box (1).

Draining the fuel filter

⚠ WARNING Risk of fire or explosion from fuel

Fuels are highly flammable.

- ▶ Fire, open flames, smoking and creating sparks must be avoided.
- ▶ Before filling up, switch off the vehicle, and, if applicable, the auxiliary heating.

⚠ WARNING Risk of fire and explosion due to fuel

Fuels are highly flammable. There is a risk of fire and explosion due to contact with hot component parts.

- ▶ Allow the engine and the exhaust system to cool down.

! NOTE Engine damage due to delayed drainage of the fuel filter

Vehicles with a diesel engine: delayed drainage of the fuel filter can lead to engine damage.

If the  indicator lamp lights up, drain the fuel filter immediately.

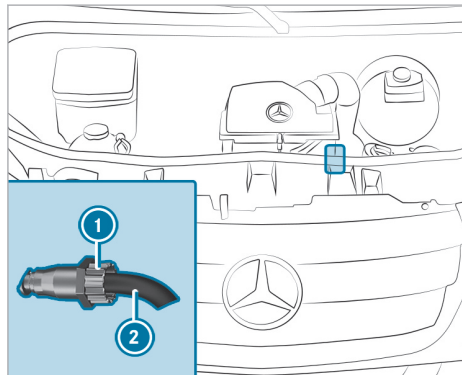

🌿 ENVIRONMENTAL NOTE Environmental pollution due to disposal in a non-environmentally responsible manner

- ▶ Dispose of the hydrogen fuel mixture in an environmentally friendly manner.



OM654 engine, rear wheel drive and all-wheel drive

- ▶ Park the vehicle in a safe location and secure it against rolling away.
- ▶ Switch off the auxiliary heating .
- ▶ Switch off the vehicle.
- ▶ Open the hood (→ page 214).
- ▶ Place a suitable collecting pan beneath the drain hose (2) .
- ▶ Switch on the vehicle.
- ▶ Open drain screw (1) until the water/fuel mixture emerges from drain hose (2) .

- ▶ Close drain screw ❶ as soon as around 0.2 qt (0.2 liters) of the water/fuel mixture has been collected.
After 30 seconds, the electrical fuel pump will automatically stop the discharge of the water/fuel mixture.
- ▶ Switch the vehicle off after draining.
- ▶ Dispose of the collected water/fuel mixture in an environmentally responsible manner, e.g. at a qualified specialist workshop.
- ▶ Check that drain screw ❶ has been closed. If the vehicle is running while drain screw ❶ is open, you will lose fuel through drain hose ❷.
- ▶ Close the hood (→ page 214).
- ▶  **The indicator lamp does not go out after draining:** Drain the fuel filter again.
- ▶  **The indicator lamp does not go out after the second draining:** Consult a qualified specialist workshop.

Mercedes-Benz recommends that you have the fuel filter drained at a qualified specialist workshop.

Cleaning and care

Notes on washing the vehicle in an automatic car wash

⚠ WARNING Risk of accident due to reduced braking effect after washing the vehicle

The braking effect is reduced after washing the vehicle.

- ▶ After the vehicle has been washed, brake carefully while paying attention to the traffic conditions until the braking effect has been fully restored.

! NOTE Risk of damage to the paintwork and plastic components

If you wash your vehicle in Touchless Automatic Car Wash systems that use special cleaning agents, the cleaning agents used can damage the paintwork or plastic components of the vehicle.

- ▶ Do not wash the vehicle in Touchless Automatic Car Wash systems that use special cleaning agents.

Make sure that the automatic car wash is suitable for the size of the vehicle.

Before washing the vehicle in an automatic car wash, fold in the outside mirrors and remove any additional antennas. Otherwise, the outside mirrors, antennas or the vehicle itself could be damaged.

Make sure any additional antennas are re-installed and that the outside mirrors are fully folded out again when you leave the automatic car wash.

To avoid damage to your vehicle, observe the following before using an automatic car wash:

- the side windows and the sliding window are completely closed.
- the blower for ventilation and heating is switched off.
- the windshield wiper switch is in position 0.

If the vehicle is very dirty, wash off excess dirt before cleaning the vehicle in an automatic car wash.

- ❗ Removing the wax from the windshield and the wiper rubbers after washing the vehicle, will help avoid smearing and reduce wiper noise.

Notes on using a power washer

⚠ WARNING Risk of an accident when using power washers with round-spray nozzles

The water jet can cause externally invisible damage.

Components damaged in this way may unexpectedly fail.

- ▶ Do not use a power washer with round-spray nozzles.
- ▶ Have damaged tires or chassis parts replaced immediately.

Never use a power washer in the vehicle interior. The amount of water accumulated by the pressure the power washer generates and the associated spray could cause considerable damage to the vehicle.

To avoid damage to your vehicle, observe the following when using a power washer:

- Maintain a distance of at least 11.8 in (30 cm) to the vehicle when using 25° flat-spray nozzles and concentrated-power jets and observe the information in the equipment manufacturer's operator's manual.
- Do not direct the nozzle of the power washer directly at sensitive parts such as tires, gaps,

electrical components, batteries, lights and ventilation louvers.

- Maintain a minimum distance of 19.7 in (50 cm) from a reversing camera.

Washing the vehicle by hand

Observe the legal requirements. For example, in a number of countries, washing by hand is permitted only in specially designated wash bays. In this case, make sure that a specially designated wash bay is used for washing by hand.

- ▶ Use a mild cleaning product, e.g. car shampoo.
- ▶ Wash the vehicle with lukewarm water and a soft car sponge. When doing so, do not expose the vehicle to direct sunlight.
- ▶ Carefully spray the vehicle with water and dry off with a chamois. Be careful not to point the water jet directly towards the air inlet grilles. Do not run the blower.
- ▶ Do not let the cleaning product dry on the paintwork.

At the onset of winter, remove all traces of road salt deposits carefully and as soon as possible.

Notes on paintwork care

! **NOTE** Paintwork damage and corrosion due to inadequate care

Failure to promptly and thoroughly remove dirt from bird droppings or other residue could result in paintwork damage and corrosion at a later date.

- ▶ Clean dirt off paint and matte finish thoroughly and as soon as possible.

Observe the notes on cleaning and care to avoid paintwork damage.

Paint

- Insect remnants: soak with insect remover and then wipe the treated areas clean.
- Bird droppings: soak with water and then wipe the treated areas clean.

- Tree resin, oils and greases: remove by rubbing gently with a cloth soaked in surgical spirit or lighter fluid.
- Coolant and brake fluid: remove with a damp cloth and clean water.
- Tar stains: use tar remover.
- Wax: use silicone remover.
- Do not attach stickers, films or similar materials.
- Remove any staining as soon as possible.

Matte finish

- Use only care products approved for Mercedes-Benz.
- Do not polish the vehicle and light-alloy wheels.
- Use only car washes that comply with the latest engineering standards. If in doubt, always consult the car wash operator, in particular regarding whether the car wash is suitable for cleaning and care of matte paint finishes.
- Do not use a car wash program with a final hot wax treatment.
- Do not use paint cleaners, buffing or polishing products, gloss preservers, e.g. wax.
- Always have paintwork repairs carried out at a qualified specialist workshop.

Notes on the care for vehicle parts

! **WARNING** Risk of entrapment if the windshield wipers are switched on while the windshield is being cleaned

If the windshield wipers are set in motion while you are cleaning the windshield or wiper blades, you can be trapped by the wiper arm.

- ▶ Always switch off the windshield wipers and the vehicle before cleaning the windshield or wiper blades.

Observe the following notes:

	Notes on cleaning and care	Preventing damage to the vehicle
Wheels/rims	Use water and acid-free wheel cleaner.	<ul style="list-style-type: none"> Do not use acidic alloy wheel cleaners to remove brake dust. Otherwise, wheel bolts and brake components could become damaged. To avoid corrosion of brake discs and pads, drive for a few minutes after cleaning before parking the vehicle. The brake discs and pads will warm up and dry out.
Windows	Clean windows inside and outside with a damp cloth and with a cleaning agent recommended for Mercedes-Benz.	Do not use dry cloths or abrasive or solvent-based cleaning agents to clean the insides of windows.
Wiper blades	With the wiper blades folded out, carefully clean them with a damp cloth.	Do not clean the wiper blades too often.
Exterior lighting	Clean the lenses with a wet sponge and mild cleaning agent (e.g. car shampoo).	Use only cleaning agents or cloths suitable for plastic lenses.
Sensors	Clean the sensors in the front and rear bumpers and in the radiator grill with a soft cloth and car shampoo.	When using a power washer, keep a minimum distance of 11.8 in (30 cm).
Rear view camera and 360° camera	Use clean water and a soft cloth to clean the camera lens.	Do not use a power washer.
Trailer hitch	<ul style="list-style-type: none"> Remove traces of rust on the ball (e.g. with a wire brush). Remove dirt with a lint-free cloth. After cleaning, lightly oil or grease the ball head. Observe the notes on care in the trailer hitch manufacturer's Operator's Manual. 	Do not clean the ball neck with a power washer or solvent.
Sliding door	<ul style="list-style-type: none"> Remove foreign objects from the vicinity of the contact plates and contact pins of the sliding door. Clean the contact plates and contact pins with a mild cleaning agent and a soft cloth. 	Do not oil or grease the contact plates or the contact pins.

Notes on cleaning and care		Preventing damage to the vehicle
Steps	<ul style="list-style-type: none"> • Clean the electrically-operated steps and their housing with a power washer. • After cleaning, spray the lateral guides with silicone spray. • Clean the steps in the bumper with a power washer. 	Do not use oil or grease as a lubricant.
aluminum side boards	<ul style="list-style-type: none"> • Brush down the aluminum side boards with water and a neutral or mild alkaline cleaning agent. 	Do not use abrasive cleaning agents to clean the side boards.

Notes on the cleaning and care of the interior

⚠ WARNING Risk of injury from plastic parts breaking off after the use of solvent-based care products

Care and cleaning products containing solvents can cause surfaces in the cockpit to become porous. When the airbags are deployed, plastic parts may break away.

- ▶ Do not use any care or cleaning products containing solvents to clean the cockpit.

⚠ WARNING Risk of injury or fatal injuries from bleached seat belts

Bleaching or dyeing seat belts can severely weaken them.

This can, for example, cause seat belts to tear or fail in an accident.

- ▶ Never bleach or dye seat belts.

! NOTE Damage to property due to incorrect leather care

The steering wheel, seat covers and other parts of the vehicle interior can be made of leather.

Leather becomes brittle and can crack if it is incorrectly cared for or cleaned.

- ▶ If it gets dirty, thoroughly wipe it with a damp cloth (water or mild soapy water) or use leather care agents or cleaners that have been recommended and approved by Mercedes-Benz. Then wipe it over again with a dry cloth.
- ▶ Do not use a microfiber cloth for cleaning.

- ▶ Do not soak the leather.
- ▶ Do not use cleaning agents containing solvents such as tar remover or wheel cleaner, polishes or waxes.

! NOTE Property damage due to disinfectants

The interior includes a number of sensitive surfaces such as displays, plastics and leather.

Disinfectants can contain alcohol and other substances that penetrate and damage surfaces. Technology behind buttons and displays can also be damaged.

- ▶ Do not use disinfectant on interior surfaces.

To prevent damage to the vehicle, observe the following notes for cleaning and care:

Seat belts

- Clean with lukewarm soapy water.
- Do not use chemical cleaning agents.
- Do not dry seat belts by heating them to over 176°F (80°C) or exposing them to direct sunlight.

Instrument cluster

- Clean the surfaces carefully with a microfiber cloth and acrylic glass care product.
- Do not use any other agents.

Display

- Switch off the display and let it cool down.
- Clean the surface carefully with a microfiber cloth and a suitable display cleaning product (TFT LCD).
- Do not use any other agents.

Digital inside rearview mirror

- Clean the mirror glass with a cloth moistened with glass cleaner.
- Clean the light sensors of the inside rearview mirror with a dry cotton cloth.
- Do not spray the glass cleaner on the mirror glass.
- Do not use any other agents.

Plastic trim

- Clean with a damp microfiber cloth.
- If very dirty: use a cleaning agent recommended for Mercedes-Benz.
- Do not attach stickers, films or similar materials.
- Do not allow to come into contact with cosmetics, insect repellent or sun creams.

Headliner

- Clean with a brush or dry shampoo.

Imitation leather seat covers

- Vacuum up dirt such as crumbs or dust and then use a damp cotton cloth and a 1% soap solution to clean the entire seat cover.
- Use cleaning and care products recommended for Mercedes-Benz.
- Do not use a microfiber cloth.
- Do not use any oil-based cleaning and care products.
- Do not spot-clean.

Cloth seat covers

- Vacuum up dirt such as crumbs or dust and then use a damp microfiber cloth and a 1% soap solution to clean the entire seat cover.
- Use cleaning and care products recommended for Mercedes-Benz.
- Do not use any oil-based cleaning and care products.
- Do not spot-clean.

Steering wheel and gear or selector lever

- Clean with a damp cloth.

Pedals and floor mats

- Clean with a damp cloth.
- Do not use any cleaning and care products.

Real wood and trim elements

- Clean with a microfiber cloth.
- Black piano-lacquer look: clean with a damp cloth and soapy water.

- If very dirty: use a cleaning agent recommended for Mercedes-Benz.
- Do not use any cleaning agents, polishes or waxes containing solvents.

Vehicle interior

- Clean with a damp cloth.
- Do not use a power washer.
- Allow the vehicle interior to dry completely after cleaning.
- Do not allow liquids to penetrate into gaps or cavities.

Curains

- The curtains may be dry-cleaned only.
- Do not wash the curtains.

Emergency

Removing the safety vest

▶ Remove the safety vest from the storage compartment in the driver's door.

- ⓘ Safety vests can also be stored in the storage compartments of the rear doors and the co-driver door.

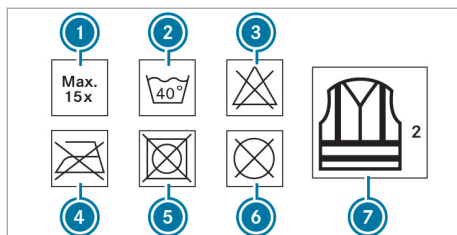

- ① Maximum number of washes
- ② Maximum wash temperature
- ③ Do not bleach
- ④ Do not iron
- ⑤ Do not tumble dry
- ⑥ Do not dry-clean
- ⑦ This is a class 2 vest

The safety vest only fulfills the legally required standards if it is the correct size and is completely closed.

Replace the safety vest if:

- Damaged or if the reflex strips are dirty
- The maximum permitted number of washes is exceeded
- The safety vest's fluorescence has faded

Removing the first-aid kit (soft sided)

The first-aid kit (soft sided) is located in the stowage compartment in the front passenger door.

▶ Remove the first-aid kit (soft sided) from the stowage compartment.

Removing the warning lamp

The warning lamp is located in the stowage compartment in the front-passenger door.

▶ Remove the warning lamp from the stowage compartment.

Emergency Call System

Information on the emergency call system

USA only: Your vehicle is equipped with the Emergency Call System ("eCall"). This feature can help save lives in the event of an accident. eCall in no way replaces assistance provided from dialing 911. eCall only functions in areas where mobile phone coverage is available from the mobile phone network provider. Insufficient network coverage from the wireless service providers may result in an emergency call not being transmitted.

eCall is a standard feature in your Mercedes-Benz vehicle. In order to function as intended, the system relies on the transmission of data detailed in the "Emergency call system data transfer" section that follows (→ page 227). To disable eCall, a customer must visit an authorized Mercedes-Benz Service department to deactivate the vehicle's communication module.

Deactivation of this module prevents the activation of any and all Mercedes me connect services. After the deactivation of eCall, automatic emergency call and manual emergency call will not be available.

The vehicle must be switched on before an automatic emergency call can be made.

- ⓘ eCall is activated at the factory.
- ⓘ eCall can be deactivated by an authorized Mercedes-Benz dealer. Please note that in the event ownership of the vehicle is transferred to another owner in its deactivated state, eCall will remain deactivated unless the new owner visits an authorized Mercedes-Benz dealership to reactivate the system.

Overview of the emergency call system

eCall can help to reduce the time between an accident and the arrival of emergency services at the site of the accident. It helps locate an accident site in places that are difficult to access. However, even if a vehicle is equipped with eCall, this does not mean the system is ON. As such, eCall does not replace dialing 911 in the event of an accident.

An emergency call can be made automatically (→ page 227) or manually (→ page 227). Only make emergency calls if you or others are in need of rescue. Do not make an emergency call in the event of a breakdown or a similar situation.

Message in the media display:

SOS NOT READY: the vehicle is not on or eCall not available.

During an active emergency call,  appears in the display.

You can find more information on the regional availability of eCall at: <https://www.mercedes-benz-mobile.com/extra/ecall/>

If there is a malfunction of the emergency call system, the speakers, microphone, air bag or the SOS button, for example, are faulty.

You can recognize a malfunction in the emergency call system by the following displays:

- The red SOS NOT READY message appears in the display of the instrument cluster or in the media display.
- The SOS button lights up red continuously.

Triggering an automatic emergency call**Requirements:**

- The vehicle is switched on.
- The starter battery is sufficiently charged.

If restraint systems such as air bags or Emergency Tensioning Devices have been activated after an accident, eCall may automatically initiate an emergency call.

When the emergency call is made:

- A voice connection is made to the Mercedes-Benz emergency call center.
- A message with accident data is transmitted to the Mercedes-Benz emergency call center.

The Mercedes-Benz emergency call center can transmit the vehicle position data to one of the emergency call centers.

The SOS button in the overhead control panel flashes until the emergency call is finished.

It is not possible to immediately end an automatic emergency call.

If no connection can be made to the emergency services either, a corresponding message appears in the media display.

- ▶ Dial the local emergency number on your mobile phone.

If an emergency call has been initiated:

- Remain in the vehicle if the road and traffic conditions permit you to do so until a voice

connection is established with the emergency call center operator.

- Based on the call, the operator decides whether it is necessary to call rescue teams and/or the police to the accident site.
- If no vehicle occupant answers, an ambulance is sent to the vehicle immediately.

Triggering a manual emergency call

- ▶ **Via the SOS button in the overhead control panel:** press the SOS button for at least one second.

- ▶ **Via voice control:** use the Voice Control System voice command "Call the Mercedes accident center".

When the emergency call is made:

- A voice connection is made to the Mercedes-Benz emergency call center.
- A message with accident data is transmitted to the Mercedes-Benz emergency call center.

The Mercedes-Benz emergency call center can transmit the vehicle position data to one of the emergency call centers.

- Remain in the vehicle if the road and traffic conditions permit you to do so until a voice connection is established with the emergency call center operator.
- Based on the call, the operator decides whether it is necessary to call rescue teams and/or the police to the accident site.

If no connection can be made to the public emergency services, a corresponding message appears in the display.

- ▶ Dial the local emergency number on your mobile phone.

Ending an unintentional manually initiated emergency call

- ▶ Select  on the multifunction steering wheel. Depress the button for several seconds.

Transmitted data with the emergency call

Data transmitted by the eCall includes but is not limited to:

- Vehicle's GPS position data
- GPS position data on the route (a few () hundred meters before the incident)
- Direction of travel

- Vehicle identification number
- Vehicle drive type
- Estimated number of people in the vehicle
- Whether the emergency call was initiated manually or automatically
- Time of the accident
- Language setting on the multimedia system

Data transmitted is vehicle information. For any questions about the collection, use and sharing of the eCall system data, please contact MBUSA's Customer Assistance Center at 800-FOR-MERC.

For Canada, please contact MBC's Customer Assistance Center at 1-800-387-0100.

Customer requests for covered information should be submitted via the same channels.

For accident clarification purposes, the following measures can be taken up to an hour after the emergency call has been initiated:

- The current vehicle position can be determined
- A voice connection to the vehicle occupants can be established

Flat tire

Notes on flat tires

⚠ WARNING Risk of accident due to a flat tire

A flat tire strongly impairs the vehicle's driving characteristics, as well as its steering and braking characteristics.

- ▶ Do not drive with a flat tire.
- ▶ Replace the flat tire with the spare wheel. Alternatively, consult a qualified specialist workshop.

In the event of a flat tire, the following options are available depending on your vehicle's equipment:

- You can make a breakdown assistance call using the breakdown assistance call button in the overhead control panel (→ page 184).
- Change the wheel (→ page 257).

Battery

Notes on the starter battery

⚠ WARNING Risk of a fire due to work carried out incorrectly on the battery

The battery clamps may be live even after they have been disconnected. This can result in a short circuit.

- ▶ Always have work on the batteries carried out at a qualified specialist workshop.
- ▶ Never disconnect the battery yourself.

⚠ WARNING Risk of an accident due to work carried out incorrectly on the battery

Work carried out incorrectly on the battery can, for example, lead to a short circuit. This can restrict functions relevant for safety systems and impair the operating safety of your vehicle.

You could lose control of the vehicle in the following situations in particular:

- When braking
- In the event of abrupt steering maneuvers and/or when the vehicle's speed is not adapted to the road conditions
- ▶ In the event of a short circuit or a similar incident, contact a qualified specialist workshop immediately.
- ▶ Do not drive on.
- ▶ Always have work on the battery carried out at a qualified specialist workshop.

- Further information on ABS (→ page 144)
- Further information on ESP® (→ page 145)

Mercedes-Benz recommends that you have the starter battery replaced at a qualified specialist workshop, e.g. an authorized Mercedes-Benz Center.

If you want to replace the battery yourself, observe the following information:

- Only replace a faulty battery with a battery which fulfills the vehicle's specific requirements.
- Carry over detachable parts such as the vent hose or terminal cover from the battery which is to be replaced.

- Make sure that the vent hose is always connected to its original opening on the battery side.

Install the existing or newly supplied stop plugs.

Otherwise, gases or battery acid could escape.

- Make sure that the detachable parts are connected in the same way as before.

For safety reasons, Mercedes-Benz recommends that you only use batteries which have been approved for your vehicle by Mercedes-Benz. These batteries provide increased impact protection to prevent vehicle occupants from suffering acid burns should the battery be damaged in an accident.

⚠ WARNING Risk of explosion due to electrostatic charge

Electrostatic charge can ignite the highly explosive gas mixture in the battery.

- ▶ To discharge any electrostatic charge that may have built up, touch the metal vehicle body before handling the battery.

The highly flammable gas mixture is created while the battery is charging and when jump-starting.

⚠ WARNING Danger of chemical burns from the battery acid

Battery acid is caustic.

- ▶ Avoid contact with the skin, eyes or clothing.
- ▶ Do not lean over the battery.
- ▶ Do not inhale battery gases.
- ▶ Keep children away from the battery.
- ▶ Immediately rinse battery acid off thoroughly with plenty of clean water and seek medical attention immediately.

🌿 ENVIRONMENTAL NOTE Environmental damage due to improper disposal of batteries



Batteries contain pollutants. It is illegal to dispose of them with the household rubbish.



Dispose of batteries in an environmentally responsible manner. Take discharged batteries to a qualified specialist workshop or to a collection point for used batteries.

Consult a qualified specialist workshop to connect the battery.

Observe the safety notes and protective measures when handling batteries.



Risk of explosion



Fire, naked flames and smoking are prohibited when handling the battery. Avoid creating sparks.



Electrolyte or battery acid is corrosive. Avoid contact with the skin, eyes and clothing. Wear suitable protective clothing, in particular gloves, an apron and a safety mask. Immediately rinse electrolyte acid splashes off with clean water. If necessary, seek medical advice.



Wear eye protection.



Keep children at a safe distance.



Observe these Operating Instructions.

If you do not use the vehicle for a long period or drive short distances regularly:

- Connect the battery to a charger recommended for Mercedes-Benz
- Consult a qualified specialist workshop to disconnect the battery

Starting assistance and charging the starter battery

- ▶ Always use the jump-start connection in the engine compartment for starting assistance and when charging the battery.

! **NOTE** Damage to the battery due to over-voltage

When charging using a battery charger without a maximum charging voltage, the battery or the on-board electronics may be damaged.

- ▶ Only use battery chargers with a maximum charging voltage of 14.8 V.

! **WARNING** Risk of explosion due to igniting hydrogen gas

If you cause a short circuit or sparks occur, the hydrogen gas may ignite when a battery is charging.

- ▶ Ensure that the positive terminal of a connected battery does not come into contact with vehicle parts.
- ▶ Never place metal objects or tools on a battery.
- ▶ When connecting and disconnecting the battery, always observe the sequence of battery terminals described.
- ▶ When jump starting, take care to connect only battery terminals of identical polarity.
- ▶ When jump starting, always observe the sequence described for connecting and disconnecting the jumper cables.
- ▶ Do not connect or disconnect the battery terminals when the engine is running.

! **WARNING** Risk of explosion due to a mixture of explosive gases

A mixture of explosive gases can escape from the battery during charging and jump starting.

- ▶ Fire, open flames, smoking and creating sparks must be avoided.
- ▶ Make sure that there is sufficient ventilation.
- ▶ Do not stand over the battery.

! **WARNING** Risk of explosion from a frozen battery

A discharged battery may freeze at temperatures slightly above or below freezing point.

During starting assistance or battery charging, battery gas can be released.

- ▶ Always allow a battery to thaw before charging it or performing starting assistance.

If the warning/indicator lamps do not light up in the instrument cluster at temperatures around or below freezing, it is highly probable that the discharged battery has frozen.

In this case, observe the following points:

- Do not give the vehicle starting assistance or charge the battery.
- The service life of a battery that has been thawed may be reduced drastically.
- The starting behavior may deteriorate, particularly at low temperatures.
- It is recommended that you have a thawed battery checked at a qualified specialist workshop.

! **NOTE** Damage caused by numerous or extended attempts to start the engine

Numerous or extended attempts to start the engine may damage the catalytic converter due to non-combusted fuel.

- ▶ Avoid numerous and extended attempts to start the engine.

When jump-starting and charging the batteries, observe the following points:

- only use undamaged jump leads/charging cables with a sufficient cross-section and insulated terminal clamps.
- non-insulated parts of the terminal clamps must not come into contact with other metal parts while the jump leads/charging cables are connected to the battery/jump-start connection point.
- the jump leads/charging cables must not come into contact with any parts which may move when the engine is running.
- make sure that neither you nor the battery is electrostatically charged
- avoid fire and naked flames

- do not lean over a battery
- When charging:** only use a battery charger that has been tested and approved by Mercedes-Benz and read the operating instructions for your charger before charging the batteries

Observe the additional following points during starting assistance:

- starting assistance may only be provided using batteries with a nominal voltage of 12-V-
- the vehicles must not touch each other
- Vehicles with a gasoline engine:** only perform starting assistance when the engine and exhaust system are cold.
- Vehicles with a battery main switch:** check whether the battery main switch is inserted (→ page 124).
- Use the parking brake to secure the vehicle.
- Vehicles with automatic transmission:** shift the transmission to position **P**.
- Vehicles with manual transmission:** shift to neutral.
- Switch off the vehicle and all electrical consumers.
- Open the hood (→ page 214).

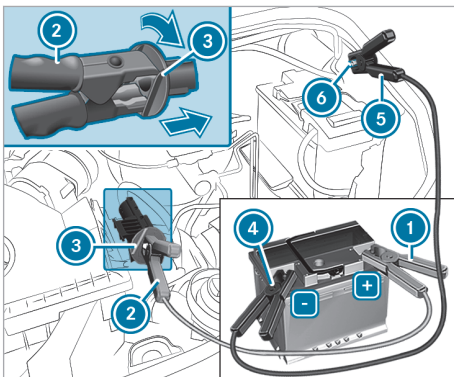

- i** **Right-hand drive vehicle:** the jump-start connection may be on the opposite side.
- Remove the cover from the POSITIVE terminal of the donor battery.
 - First connect a red POSITIVE terminal clamp **1** of the starting assistance/charging cable to the POSITIVE terminal of the donor battery.
 - With second red POSITIVE terminal clamp **2** of the starting assistance/charging cable, slide

the red protective cap on jump-start connection **3** back with a clockwise turn.

- Attach second red POSITIVE terminal clamp **2** to the POSITIVE terminal of jump-start connection **3**.
- During starting assistance:** start the engine of the donor vehicle and let it run at idle speed.
- First, connect a black NEGATIVE terminal clamp **4** of the starting assistance/charging cable to the NEGATIVE terminal of the donor battery.
- Connect second black NEGATIVE terminal clamp **5** of the jump lead/charging cable to earth point **6** on your own vehicle (bare metal part in the engine compartment).
- During starting assistance:** start the vehicle.
- When charging:** start the charging process.
- During starting assistance:** let the engine run for a few minutes.
- During starting assistance:** before disconnecting the jump lead, switch on an electrical consumer on your own vehicle, e.g. the rear window heating or lighting.

When the starting assistance/charging process is complete:

- Remove the terminal clamps of the starting assistance/charging cable in reverse order. First remove second black NEGATIVE terminal clamp **5** from earth point **6** in the engine compartment. Then remove black NEGATIVE terminal clamp **4** from the donor battery. Then remove second red POSITIVE terminal clamp **2** from the POSITIVE terminal of jump-start connection **3**. Then remove red POSITIVE terminal clamp **1** from the donor battery. The red protective cap springs back to its initial position when second red POSITIVE terminal clamp **2** is disconnected from jump-start connection **3**.

You can obtain further information at a qualified specialist workshop.

Towing or tow-starting

Overview of permissible towing methods

In the event of a breakdown, Mercedes-Benz recommends that you have the vehicle transported instead of towed.

NOTE Damage to the vehicle due to towing away incorrectly



▶ Observe the instructions and notes on towing away.

i **Vehicles with automatic transmission and rear-wheel drive:** if there is a malfunction, the auto-

matic transmission may be locked in position **P**.

If the automatic transmission cannot be shifted to position **N**, transport the vehicle (→ page 232). A tow truck with lifting equipment is required to transport the vehicle.

Permissible towing methods

			
	Both axes on the ground	Front axle raised	Rear axle raised
Vehicles with automatic transmission and rear-wheel drive	Yes, no further than 31 miles (50 km) at 31 mph (50 km/h)	Yes, no further than 31 miles (50 km) at 31 mph (50 km/h)	Yes, if the steering wheel is immobilized in the center position with a steering wheel lock
Vehicles with all-wheel drive	Yes, no further than 31 miles (50 km) at 31 mph (50 km/h)	No	No

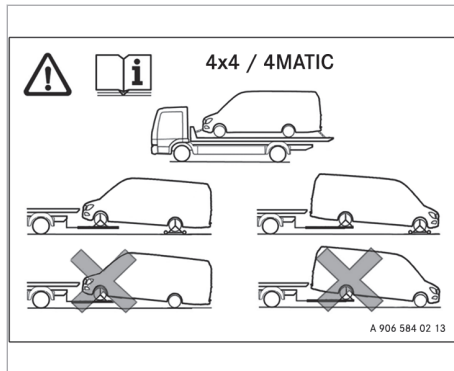

Vehicles with all-wheel drive: warning notice on the B-pillar on the driver's side

Towing with a raised axle: towing should be done by a towing company.

Loading the vehicle for transport

- ▶ Observe the notes on permissible towing methods (→ page 231).
- ▶ Connect the tow bar to the towing eye to load the vehicle.

▶ **Vehicles with automatic transmission:** shift the automatic transmission to position **N**.

i **Vehicles with automatic transmission:** in the event of damage to the electrics, the automatic transmission may be locked in position **P**. To shift to position **N**, provide the on-board electrical system with power (→ page 230).

▶ Load the vehicle onto the transporter.

▶ **Vehicles with automatic transmission:** shift the automatic transmission to position **P**.

▶ Use the parking brake to secure the vehicle against rolling away.

▶ Only secure the vehicle by the wheels.

Vehicles with all-wheel drive/vehicles with automatic transmission

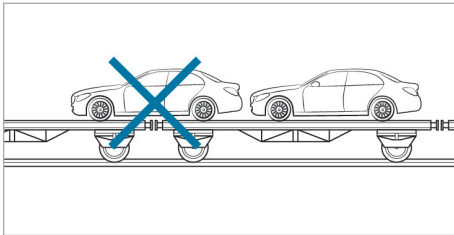

- ▶ Make sure that the front and rear axles come to rest on the same transportation vehicle.

! **NOTE** Damage to the drive train due to incorrect positioning of the vehicle

- ▶ Do not position the vehicle above the connection point of the transport vehicle.

Towing eye storage location

The towing eye is located in the vehicle tool kit in the front passenger footwell (→ page 233).

Installing/removing the towing eye

Installing the front towing eye

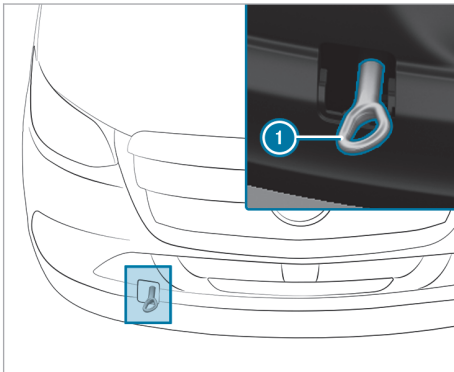

- ▶ Press the top of the cover and remove the cover.
- ▶ Screw in towing eye ① as far as it will go.

Removing the front towing eye

- ▶ Unscrew towing eye ① counter-clockwise.
- ▶ Insert the cover with the tabs at the top and push in at the bottom until the cover engages.

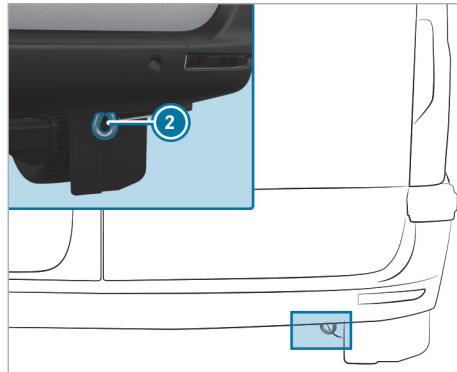

Rear towing eye

- ① Rear towing eye ② is permanently attached to the vehicle.

! **NOTE** Damage to the vehicle due to incorrect use of the towing eye or trailer hitch

When a towing eye or trailer hitch is used to recover a vehicle, the vehicle may be damaged in the process.

- ▶ Only use the towing eye or trailer hitch to tow away or tow start the vehicle.
- ▶ Do not use the towing eye or trailer hitch to tow the vehicle during recovery.

Tow-starting the vehicle

! **NOTE** Damage to the automatic transmission due to tow starting

The automatic transmission may be damaged in the process of tow starting vehicles with automatic transmission.

- ▶ Vehicles with automatic transmission must not be tow started.

Electrical fuses

Notes on electrical fuses

! **WARNING** Risk of accident and injury due to overloaded lines

If you manipulate or bridge a faulty fuse or if you replace it with a fuse with a higher amperage, the electric line could be overloaded.

This could result in a fire.

- ▶ Always replace faulty fuses with specified new fuses containing the correct amperage.

! **NOTE** Damage due to incorrect fuses

Electrical components or systems could be damaged by incorrect fuses.

- ▶ Only use fuses which have been approved by Mercedes-Benz and which have the correct fuse rating.

The electrical fuses in your vehicle isolate defective circuits. If a fuse blows, all the components on the circuit and their functions will cease to operate.

Blown fuses must be replaced with fuses of an equivalent specification, which you can determine by the color and fuse rating. The fuse allocation chart and further information on the electric fuses and relays can be found in the "Fuse allocation chart" supplement.

! **NOTE** Damage or malfunctions caused by moisture

Moisture may cause damage to the electrical system or cause it to malfunction.

- ▶ When the fuse box is open, make sure that no moisture can enter the fuse box.
- ▶ When closing the fuse box, make sure that the seal of the lid is positioned correctly on the fuse box.

If the new fuse which has been inserted also blows, have the cause traced and rectified at a qualified specialist workshop.

Make sure of the following before replacing a fuse:

- The vehicle is secured such that it does not roll away.
- All electrical consumers are switched off.
- The vehicle is switched off.

The fuses are located in various fuse boxes:

- Fuse box in the co-driver footwell (→ page 234)
- Fuse box in the seat base of the driver's seat (→ page 234)

Opening the fuse box in the seat base of the driver's seat

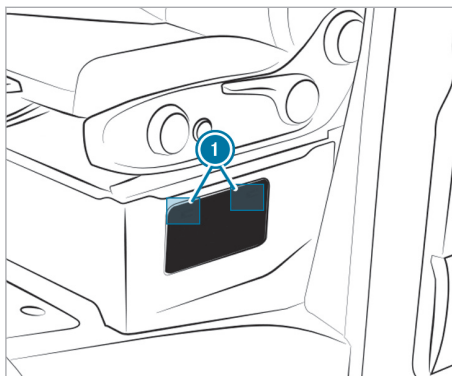

- ▶ **To open:** press down and unclip fasteners ① on the cover.
- ▶ Remove the cover.
- ▶ **To close:** press the cover firmly into the seat base until fasteners ① clip in.

Opening and closing the fuse box in the co-driver's footwell

Opening the fuse box

- ▶ Unlocking and removing the stowage compartment cover in the co-driver's footwell (→ page 235).

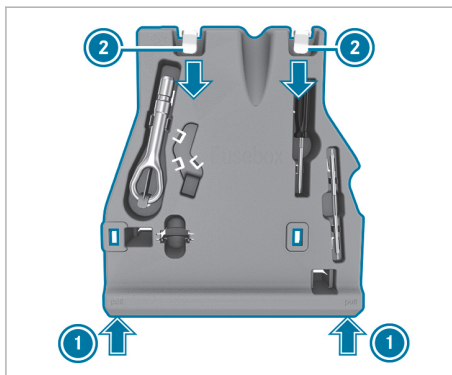

Example: vehicle tool kit insert

- ▶ Lift the insert at marked positions ①.
- ▶ Pull the insert out of clips ②.

Closing the fuse box

- ▶ Slide the insert into clips ②.
- ▶ Close the insert by pressing on marked positions ①.
- ▶ Put on the stowage compartment cover in the co-driver's footwell and lock it (→ page 235).

Vehicle tool kit

Information on the vehicle tool kit

The vehicle tool kit is located in the stowage compartment in the footwell on the front passenger side (→ page 235).

The vehicle tool kit contains:

- a towing eye
- a screwdriver with Torx®, Phillips and slotted heads

The vehicle tool kit may also contain the following, for example:

- an open-end wrench
- a wheel wrench
- a release tool for the parking lock
- an insert bit
- a socket wrench
- tool for unlocking the lockable DEF® filler cap

Unlocking and removing the stowage compartment cover

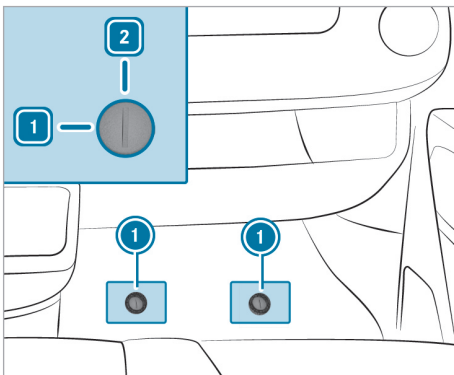

- ▶ Remove the rubber mat from the co-driver's footwell.
- ▶ **To unlock:** turn quick-release fastener ① counter-clockwise to position ①.

- ▶ Slightly raise and pull out the cover.

Inserting and locking the cover

- ▶ Slide in the cover and press it downwards.
- ▶ Press down quick-release fastener ① until it engages.
- ▶ **To lock:** turn quick-release fastener ① clockwise to position ②.

Removing the vehicle tool kit

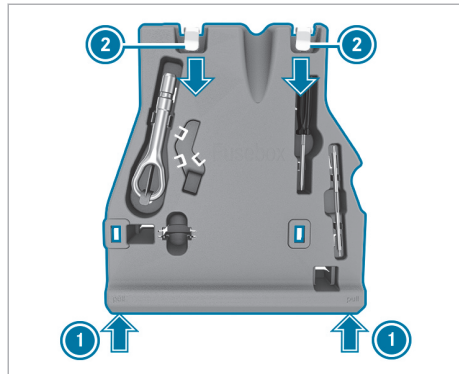

Example: vehicle tool kit insert

- ▶ Lift the insert at marked positions ①.
- ▶ Pull the insert out of clips ②.

Storing the vehicle tool kit

- ▶ Slide the insert into clips ②.
- ▶ Close the insert by pressing on marked positions ①.

Hydraulic jack

Information on the hydraulic jack

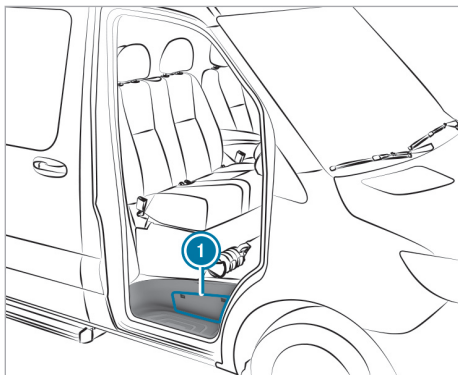

The hydraulic jack is located in side compartment ① above the co-driver door step.

Vehicles with more than 18 seats

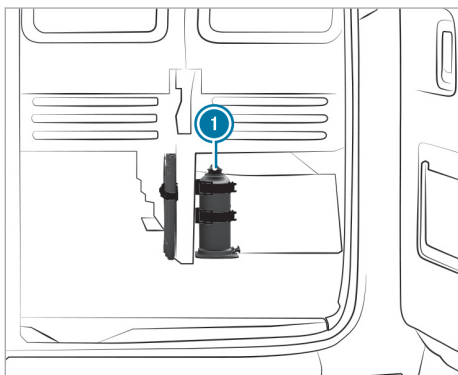

Hydraulic jack ① is located behind the last bench seat on the right.

The jack has a maximum weight of 16.5 lbs (7.5 kg) depending on the vehicle's equipment. You will find the maximum load capacity of the jack stated on the adhesive label attached to the jack. If there is a malfunction, please contact a qualified specialist workshop.

Jack maintenance:

- Clean and grease all moving parts after use.
- Extend and retract the pistons fully every six months.

Removing the pump lever rod and the jack

Requirements:

- The co-driver door is open.

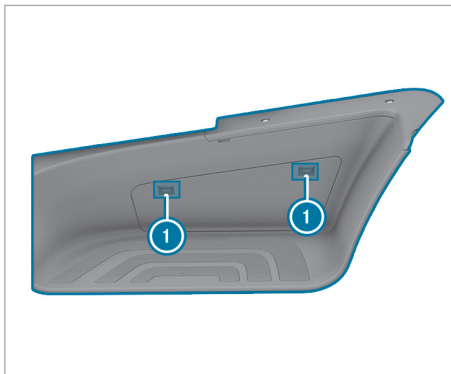

- ▶ **To open:** press down and unclip fasteners ① on the cover.
- ▶ Remove the cover.
- ▶ Pull out the holder completely and place it on the step.

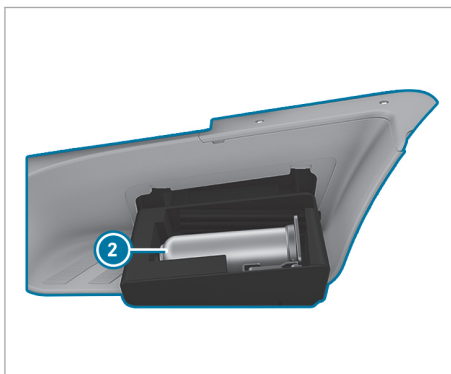

- ▶ Remove jack ② and the pump lever rod.
- ▶ **To close:** press the cover firmly so that fasteners ① engage.

Vehicles with more than 18 seats**Requirement:**

- The right-hand rear-end door is open.

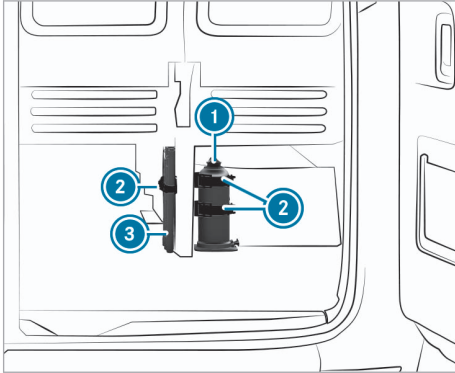

- ▶ Open clasps (2) on jack (1), loosen the straps and remove the jack.
- ▶ Open clasp (2) on pump lever rod (3), loosen the straps and remove the pump lever rod.
- ▶ **To stow:** collapse pump lever rod (3) and place it along with jack (1) in the loosened straps, and tighten clasps (2) to close.

Information on noise or unusual driving characteristics

While driving, pay attention to vibrations, noises and unusual driving characteristics, e.g. pulling to one side. This may indicate damage to the wheels or tires. If you suspect that a tire is defective, reduce your speed. Stop the vehicle as soon as possible to check if wheels and tires have been damaged or are no longer functioning properly. Hidden tire damage could also be causing the unusual driving characteristics. If no signs of damage can be detected, have the tires and wheels checked at a qualified specialist workshop.

Notes on regularly inspecting wheels and tires

⚠ WARNING Risk of injury through damaged tires

Damaged tires can cause tire pressure loss.

- ▶ Check the tires regularly for signs of damage and replace any damaged tires immediately.

Check the wheels and tires of your vehicle for damage regularly, i.e. at least every two weeks, as well as after driving off-road or on rough roads. Damaged wheels can cause a loss of tire pressure.

Look out for the following types of damage, for example:

- cuts in the tires
- punctures in the tires
- tears in the tires
- bulges on tires
- deformation or severe corrosion on wheels

⚠ WARNING Risk of hydroplaning due to insufficient tire tread

Insufficient tire tread will result in reduced tire grip.

- ▶ Thus, you should regularly check the tread depth and the condition of the tread across the entire width of all tires.

Minimum tread depth for:

- Summer tires: $\frac{1}{8}$ in (3 mm)
- M+S tires: $\frac{1}{4}$ in (4 mm)

- ▶ For safety reasons, replace the tires before the legally prescribed limit for the minimum tread depth is reached.

Conduct the following checks regularly on all wheels, at least once a month or as required, e.g. before a long journey or when driving off-road:

- check the tire pressure (→ page 240)
- check the valve caps

Valves must be protected from moisture and dirt with valve caps specifically approved by Mercedes-Benz for your vehicle.

- visually inspect the tread depth and the tire contact surface across the whole tire width

The minimum tread depth for summer use is $\frac{1}{8}$ in (3 mm) and for winter use $\frac{1}{4}$ in (4 mm).

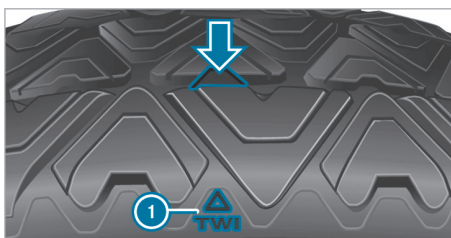

Markings ① show in which places the bar indicators (arrow) are integrated into the tire tread. They are visible as soon as the tread depth is approximately $\frac{1}{16}$ in (1.6 mm).

Information on driving with summer tires

At temperatures below 50 °F (10 °C) summer tires significantly lose elasticity and thus traction and stopping power. Change the tires on your vehicle to M+S tires. Using summer tires at very cold temperatures could cause cracks to form, thereby damaging the tires permanently. Mercedes-Benz cannot accept responsibility for this type of damage.

Always observe the maximum permissible speed specified for the mounted summer tires (→ page 252).

After you mount the summer tires:

- restart the tire pressure monitoring system (→ page 246)
- check the tire pressure (→ page 240)

Information on M+S tires

⚠ WARNING Risk of accident caused by incorrect wheel and tire dimensions

The wheel or tire sizes and the tire type of the emergency spare wheel or spare wheel and the wheel to be replaced may differ. The emergency spare wheel or spare wheel can significantly impair driving characteristics of the vehicle.

To prevent hazardous situations:

- ▶ Drive carefully.
- ▶ Never install more than one emergency spare wheel or spare wheel that differs in size.
- ▶ Only use an emergency spare wheel or spare wheel briefly.
- ▶ Do not deactivate ESP®.
- ▶ Have the emergency spare wheel or spare wheel of a different size replaced at the nearest qualified specialist workshop. The new wheel must have the correct dimensions.

⚠ WARNING Risk of an accident due to insufficient tire tread

M+S tires with a tread depth of less than 1/8 in (4 mm) are not suitable for use in winter and do not provide sufficient grip.

- ▶ M+S tires with a tread depth of less than 1/8 in (4 mm) must be replaced immediately.

At temperatures below 50 °F (10 °C) use winter tires or all-season tires marked M+S.

Only winter tires bearing the  snowflake symbol in addition to the M+S marking provide the best possible grip in wintry road conditions.

Only these tires allow driving safety systems such as ABS and ESP® to also function optimally in winter. These tires have been developed specifically for driving in snow.

Use M+S tires of the same make and tread pattern on all wheels to maintain safe handling characteristics.

Observe the maximum permissible speed specified for the mounted M+S tires (→ page 252).

If you install M+S tires that have a lower maximum permissible speed than the maximum design speed of the vehicle, affix an appropriate informa-

tion label in the driver's field of vision. You can obtain this at a qualified specialist workshop.

After you mounted the M+S tires, do the following:

- restart the tire pressure monitoring system (→ page 246)
- check the tire pressure (→ page 246)

Notes on snow chains

⚠ WARNING Risk of accident due to incorrectly installed snow chains

Vehicles with rear-wheel drive: if you have installed snow chains to the front wheels, they may drag against the vehicle body or chassis components.

- ▶ Never install snow chains on the front wheels.
- ▶ Only install snow chains on the rear wheels in pairs.
- ▶ **Vehicles with twin tires:** install the snow chains on the outer wheels.

⚠ WARNING Risk of accident due to unsuitable snow chains

Commercially available snow chains can come loose and damage chassis components or brake hoses.

- ▶ Only install snow chains that have been approved by Mercedes-Benz for these tires.

For safety reasons, Mercedes-Benz recommends that you only use snow chains that have been tested and approved. You can obtain information about snow chains from any qualified specialist workshop.

⚠ WARNING Risk of accident due to snow chains breaking

If you drive too fast with snow chains, they can break, injure other persons, and damage the vehicle.

- ▶ Observe the maximum permissible speed for operation with snow chains.

! **NOTE** Damage to the wheel trim from mounted snow chains

If snow chains are mounted to steel wheels, the wheel trims can be damaged.

- ▶ Remove the wheel trims of steel wheels before mounting snow chains.

Observe the following notes when using snow chains:

- Snow chains are only permissible for certain wheel/tire combinations. You can obtain information about this at a qualified specialist workshop.
 - For safety reasons, only use snow chains that have been specifically approved for your vehicle by Mercedes-Benz, or snow chains of the same quality.
 - The snow chains must be retightened after driving approximately 0.6 miles (1 km). This is the only way to ensure that the snow chains are optimally installed with enough clearance from adjacent components.
 - **Vehicles with all-wheel drive:** install snow chains on the rear wheels. On vehicles with twin tires, install the snow chains on the outer wheels. Observe the manufacturer's installation instructions.
 - Use snow chains only when the road surface is completely snow-covered. Remove the snow chains as soon as possible when you come to a road that is not snow-covered.
 - Local regulations may restrict the use of snow chains. Observe the applicable regulations before installing snow chains.
 - Activate all-wheel drive before starting to drive with snow chains (→ page 127).
 - If snow chains are installed, the maximum permissible speed is 30 mph (50 km/h).
 - **Vehicles with Parking Assist:** do not use Parking Assist PARKTRONIC when snow chains are installed.
- i** You can deactivate ESP® for starting off (→ page 146). This allows the wheels to spin, achieving increased propulsive power.

Tire pressure

Notes on tire pressure

⚠ WARNING Risk of accident due to insufficient or excessive tire pressure

Underinflated or overinflated tires pose in particular the following risks:

- The tires can burst.
- The tires can wear excessively and/or unevenly.
- The driving characteristics as well as the steering and braking characteristics may be greatly impaired.

▶ Comply with the recommended tire pressures and check the tire pressure of all tires, including the spare wheel, regularly:

- Monthly
- When the load changes
- Before embarking on a longer journey
- If operating conditions change, e.g. off-road driving

▶ Adjust the tire pressure, if necessary.

Driving with tire pressure that is too high or too low can:

- shorten the service life of the tires
- contribute to tire damage
- adversely affect driving characteristics and thus driving safety, e.g. due to hydroplaning.

⚠ WARNING Risk of accident due to too low a tire pressure

Tires with pressure that is too low can overheat and burst as a consequence.

In addition, they also suffer from irregular wear, which can significantly impair the braking properties and the handling characteristics.

▶ Avoid excessively low tire pressure.

tire pressure which is too low can lead to:

- tire defects as a result of overheating
- impaired handling characteristics
- uneven wear
- increased fuel consumption

⚠ WARNING Risk of accident due to too high a tire pressure

Tires with excessively high pressure can burst. In addition, they also suffer from irregular wear, which can significantly impair the braking properties and the handling characteristics.

▶ Avoid excessively high tire pressures.

tire pressure which is too high can lead to:

- increased braking distance
- impaired handling characteristics
- uneven wear
- impaired driving comfort
- susceptibility to damage

⚠ WARNING Risk of accident due to repeated pressure drop in the tires

The wheels, valves or tires could be damaged. Too low a tire pressure can lead to the tires bursting.

▶ Examine the tires for foreign objects.

▶ Check whether the tire has a puncture or the valve has a leak.

▶ If you are unable to rectify the damage, contact a qualified specialist workshop.

You can find information on recommended tire pressure for the vehicle's factory-installed tires on the following labels:

- tire and loading information and tire pressure table on the B-pillar of your vehicle (→ page 247).

Observe the maximum tire pressure (→ page 252).

Use a suitable pressure gauge to check the tire pressure. The outward appearance of a tire does not permit any reliable conclusion about the tire pressure.

🔥 ENVIRONMENTAL NOTE Environmental damage due to insufficient or excessive tire pressure

Overinflating or underinflating your tires will shorten their service life.

- ▶ Check the tire pressure regularly, but at least every 14 days.

Vehicles with a tire pressure monitoring system:

you can also check the tire pressure using the on-board computer.

Only check tire pressure when the tires are cold. Conditions for cold tires:

- The vehicle has been parked with the tires out of direct sunlight for at least three hours.
- The vehicle has travelled less than 1 mile (1.6 km).

A rise in the tire temperature of 18°F (10°C) increases the tire pressure by approx. 10 kPa (0.1 bar/1.5 psi). Take this into account when checking the tire pressure of warm tires.

The tire pressure recommended for increased load/speed in the tire pressure table may affect the ride comfort.

⚠ WARNING Risk of accident due to unsuitable accessories on tire valves

If you mount unsuitable accessories onto tire valves, the tire valves may be overloaded and malfunction, which can cause tire pressure loss.

▶ Only screw standard valve caps or valve caps specifically approved by Mercedes-Benz for your vehicle onto the tire valve.

Notes on trailer operation

The applicable tire pressure for the tires of the rear axle is always the recommended tire pressure for a full load.

Overview of the tire pressure table

The tire pressure table can be found on the seat base or on the B-pillar on the driver's side.

- ⓘ The data in the images are shown as examples.

	kPa	bar	psi	kPa	bar	psi	kPa	bar	psi	kPa	bar	psi
Truck												
Van												
Car												

The tire pressure table shows the recommended tire pressure for the tires installed on this vehicle at the factory. The recommended tire pressures are valid for cold tires and different vehicle load conditions.

If one or more tire sizes precede the tire pressures, the tire pressure information following is only valid for those tire sizes.

If the preceding tire sizes are supplemented by the  symbol, the subsequent tire pressure information shows alternative tire pressures.

The load conditions "partially laden" and "fully laden" are defined in the table by varying weights.

Some tire pressure tables only show the rim diameter instead of the complete tire sizes, e.g. **R16**.

The rim diameter is part of the tire size and can be found on the sidewall of the tire (→ page 252).

Front axle tire pressures on vehicles with all-wheel/rear-wheel drive and single tires

Front axle tire pressures with a max. front axle load of 4101 lbs (1860 kg)

Tire/disk wheel	Load condition	Max. front axle load 4101 lbs (1860 kg)
LT245/75R16 120/116Q	Fully laden	320 kPa (3.2 bar/46 psi)

Front axle tire pressures on vehicles with rear-wheel drive and single tires

Front axle tire pressures with a max. front axle load of 4409 lbs (2000 kg)

Tire/disk wheel	Load condition	Max. front axle load 4409 lbs (2000 kg)
LT245/75R16 120/116Q	Fully laden	360 kPa (3.6 bar/52 psi) ¹⁾

¹⁾ Only applies to vehicles with a long wheelbase 171 in (4350 mm) and a permissible gross mass of over 7716 lbs (3.5 t).

Rear axle tire pressures on vehicles with all-wheel/rear-wheel drive and single tires

Rear axle tire pressures with a max. rear axle load of 5357 lbs (2430 kg)

Tire/disk wheel	Load condition	Max. rear axle load 5357 lbs (2430 kg)
LT245/75R16 120/116Q	Fully laden	480 kPa (4.8 bar/70 psi)
LT245/75R16 120/116Q	Partially laden ²⁾	420 kPa (4.2 bar/61 psi) ²⁾

²⁾ Use of this reduced tire pressure is only permissible if it can be guaranteed by weighing the vehicle that the rear axle load of 4960 lbs (2250 kg) is not exceeded. In case of doubt, inflate to 480 kPa (4.8 bar/70 psi).

Front axle tire pressures for vehicles with all-wheel/rear-wheel drive and twin tires

Front axle tire pressures with a max. front axle load of 4079 lbs (1850 kg)

Tire/disk wheel	Load condition	Max. front axle load 4079 lbs (1850 kg)
LT215/85R16 115/112Q	Fully laden	380 kPa (3.8 bar/55 psi)

Front axle tire pressures with a max. front axle load of 4409 lbs (2000 kg)

Tire/disk wheel	Load condition	Max. front axle load 4409 lbs (2000 kg)
LT215/85R16 115/112Q	Fully laden	420 kPa (4.2 bar/61 psi)

Front axle tire pressures with a max. front axle load of 4630 lbs (2100 kg)

Tire/disk wheel	Load condition	Max. front axle load 4630 lbs (2100 kg)
LT215/85R16 115/112Q	Fully laden	450 kPa (4.5 bar/65 psi)

Rear axle tire pressures for vehicles with all-wheel/rear-wheel drive and twin tires

Rear axle tire pressures with a max. rear axle load of 7055 lbs (3200 kg)

Tire/disk wheel	Load condition	Max. rear axle load up to 7055 lbs (3200 kg)
LT215/85R16 115/112Q	Fully laden	370 kPa (3.7 bar/54 psi)

Rear axle tire pressures with a max. rear axle load of 7716 lbs (3500 kg)

Tire/disk wheel	Load condition	Max. rear axle load 7716 lbs (3500 kg)
LT215/85R16 115/112Q	Fully laden	400 kPa (4.0 bar/58 psi)

Rear axle tire pressures with a max. rear axle load of 7937 lbs (3600 kg)

Tire/disk wheel	Load condition	Max. rear axle load 7937 lbs (3600 kg)
LT215/85R16 115/112Q	Fully laden	420 kPa (4.2 bar/61 psi)

Front axle tire pressures on vehicles with super single tires

Front axle tire pressures with a max. front axle load of 4079 lbs (1850 kg)

Tire/disk wheel	Load condition	Max. front axle load 4079 lbs (1850 kg)
225/75R16C 121/120R (122L)	Fully laden	340 kPa (3.4 bar/49 psi)

Front axle tire pressures with a max. front axle load of 4409 lbs (2000 kg)

Tire/disk wheel	Load condition	Max. front axle load 4409 lbs (2000 kg)
225/75R16C 121/120R (122L)	Fully laden	370 kPa (3.7 bar/54 psi)

Rear axle tire pressures on vehicles with rear-wheel drive and super single tires

Rear axle tire pressures with a max. rear axle load of 7055 lbs (3200 kg)

Tire/disk wheel	Load condition	Max. rear axle load 7055 lbs (3200 kg)
285/65R16C 131R	Fully laden	460 kPa (4.6 bar/67 psi)

Rear axle tire pressures with a max. rear axle load of 7716 lbs (3500 kg)

Tire/disk wheel	Load condition	Max. rear axle load 7716 lbs (3500 kg)
285/65R16C 131R	Fully laden	520 kPa (5.2 bar/75 psi)

Be sure to also observe the following further related subjects:

- Notes on tire pressure (→ page 240)
- Tire and Loading Information placard (→ page 247)
- Maximum tire pressure (→ page 252)

Overview of tire pressure table for emergency spare wheels

Tire/emergency spare wheel	pressure	in conjunction with vehicle tire size
225/75 R16C 121/120R (122L) ¹⁾	370 kPa (3.7 bar/54 psi)	225/75 R16C 121/120R (122L)
225/75 R16C 121/120R (122L) ¹⁾	690 kPa (6.9 bar/100 psi)	285/65 R16C 131R

¹⁾ Valid for use as an emergency spare wheel on super-single vehicles for a maximum distance of 100 km (62 mi) and a maximum permissible speed of 55 km/h (34 mph).

Tire pressure monitoring system

Function of the tire pressure monitoring system

⚠ DANGER Risk of accident due to incorrect tire pressure

Each tire, including the spare (if provided), should be checked monthly when cold and inflated to the inflation pressure recommended by the vehicle manufacturer on the vehicle placard or tire inflation pressure label. (If your

vehicle has tires of a different size than the size indicated on the vehicle placard or tire inflation pressure label, you should determine the proper tire inflation pressure for those tires.)

As an added safety feature, your vehicle has been equipped with a tire pressure monitoring system (TPMS) that illuminates a low tire pressure telltale when one or more of your tires is significantly under-inflated. Accordingly, when the low tire pressure telltale illuminates, you should stop and check your tires as soon as possible, and inflate them to the proper pressure. Driving on a significantly under-inflated tire causes the tire to overheat and can lead to tire failure. Under-inflation also reduces fuel efficiency and tire tread life, and may affect the vehicle's handling and stopping ability. Please note that the TPMS is not a substitute for proper tire maintenance, and it is the driver's responsibility to maintain correct tire pressure, even if under-inflation has not reached the level to trigger illumination of the TPMS low tire pressure telltale.

Your vehicle has also been equipped with a TPMS malfunction indicator to indicate when the system is not operating properly. The TPMS malfunction indicator is combined with the low tire pressure telltale. When the system detects a malfunction, the telltale will flash for approximately one minute and then remain continuously illuminated. This sequence will continue upon subsequent vehicle start-ups as long as the malfunction exists.

When the malfunction indicator is illuminated, the system may not be able to detect or signal low tire pressure as intended. TPMS malfunctions may occur for a variety of reasons, including the installation of replacement or alternate tires or wheels on the vehicle that prevent the TPMS from functioning properly.



The system checks the pressures and temperatures of the tires installed on the vehicle by means of a tire pressure sensor.

New tire pressure sensors, e.g. in winter tires, will automatically be calibrated during the first journey.

The tire pressure and the tire temperature will appear on the display of the instrument cluster (→ page 178).

If there is a substantial loss of tire pressure, a warning will be issued:

- via display messages (→ page 298)
- via the  warning lamp on the instrument cluster (→ page 313)

It is the driver's responsibility to set the tire pressure to the recommended cold tire pressure suitable for the operating situation. Set the tire pressure for cold tires using a tire pressure gauge. Note that the tire pressure monitoring system must first learn the correct tire pressure for the current operating situation.

In most cases, the tire pressure monitoring system will automatically update the new reference values after you have changed the tire pressure. However, you can also update the reference values by restarting the tire pressure monitoring system manually (→ page 246).

System limits

The system may be impaired or inoperative in the following situations:

- if the tire pressure has been set incorrectly
- if there is a sudden pressure loss caused, for example, by a foreign object penetrating the tire
- if there is a malfunction caused by another radio signal source
- if there is a change in tire size

Bear in mind the following related topic:

- Notes on tire pressure (→ page 240)

■ Checking the tire pressure with the tire pressure monitoring system

Requirements

- The vehicle is switched on.

On-board computer:

↳ Service ▶▶ Tires

One of the following displays will appear:

- The current tire pressure and temperature for each wheel.

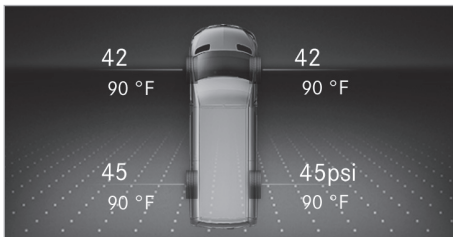

Instrument cluster display (color)

- The current tire pressure for each wheel.

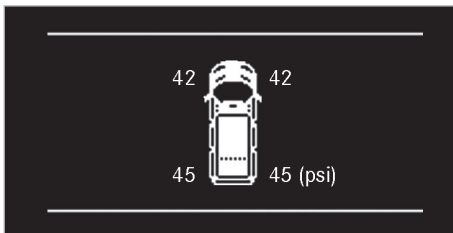

Instrument cluster display (black and white)

- **Tire pressure will be displayed after driving a few minutes.:** The teach-in process of the system is not yet complete. The tire pressure are already being monitored.
- ▶ Compare the tire pressure with the recommended tire pressure for the current operating status (→ page 241). Observe the notes on tire temperature (→ page 240).
- ⓘ The values displayed on the instrument cluster display may deviate from those of the tire pressure gauge, as they refer to sea level. At high elevations, the tire pressure value indicated by a pressure gauge will be higher than

those shown by the on-board computer. In this case, do not reduce the tire pressure.

Bear in mind the following related topic:

- Notes on tire pressure (→ page 240)

■ Restarting the tire pressure monitoring system

Requirements

- The recommended tire pressure is correctly set for the respective operating condition on each of the wheels (→ page 240).
- **Restart the tire pressure monitoring system in the following situations:**
 - The tire pressure has changed.
 - The wheels or tires have been changed or newly installed.

Instrument cluster:

↳ Service ▶▶ Tires

- ▶ Scroll down on the menu. A message reading **Use current pressures as new reference values?** will appear on the instrument cluster.
- ▶ Confirm the message to initiate a restart. A message reading **Tire Press. Monitor Restarted** will appear on the instrument cluster. Current warning messages will be deleted and the yellow  warning lamp will go out. Once you have been driving for a few minutes, the system will check whether the current tire pressure are within the specified range. The current tire pressures will then be accepted as reference values and monitored.

Bear in mind the following related topic:

- Notes on tire pressure (→ page 240)

Radio equipment approval of the tire pressure monitoring system

Country	Radio equipment approval number
Canada	IC: 4008C-TSSRE4A Operation is subject to the following two conditions: (1) this device may not cause harmful interference, and (2) this device must accept any interference received, including interference that may cause undesired operation.
Mexico	Model: TSSRE4A & TSSSG4G6, IFETEL: RLVHUTS17-0806
USA	FCC ID: YGOTSSRE4A This device complies with Part 15 of the FCC Rules. Operation is subject to the following two conditions: (1) this device may not cause harmful interference, and (2) this device must accept any interference received, including interference that may cause undesired operation. WARNING: Any changes or modification not expressly approved by the party responsible for compliance could void the user's authority to operate this equipment.

Loading the vehicle

Tire and Loading Information placard

⚠ WARNING Risk of an accident when driving with an overloaded tire

Overloaded tires may overheat and burst. Overloaded tires can impair the steering and handling characteristics and lead to brake failure.

- ▶ Observe the load rating of the tires.
- ▶ The load rating must be at least half the permissible axle load of the vehicle.
- ▶ Mercedes-Benz recommends you use the load-bearing index, which is given in the vehicle documents.
- ▶ Never overload the tires by exceeding the maximum load.

Only vehicles with a gross vehicle weight of less than 10,000 lbs (4,536 kg) have a Tire and Loading Information placard on the B-pillar on the driver's side.

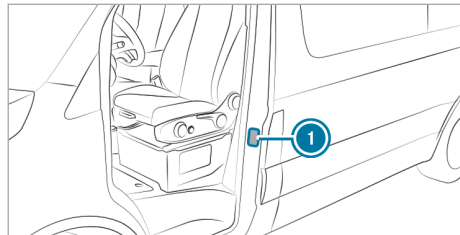

1 Tire and Loading Information placard

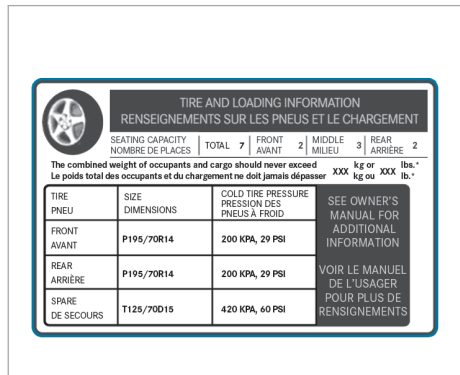

i The data shown in the illustration are sample data.

The Tire and Loading Information placard shows:

- The maximum number of seats indicates the maximum number of occupants permitted to travel in the vehicle.
- The maximum permissible load equals the gross weight of all vehicle occupants, the luggage and any payload.
- The recommended tire pressure for cold tires. The recommended tire pressures apply to the maximum permissible load and up to the maximum permissible vehicle speed.

Also observe the following information:

- The information about permissible weights on the vehicle identification plate (→ page 269)
- The information about tire pressures in the tire pressure table (→ page 241)

Additional related subjects:

- Determining the maximum payload (→ page 248)
- Notes on tire pressure (→ page 240)

Steps to determine the correct maximum load

The following steps have been developed based on the mandatory requirements for all manufacturers under Title 49, Code of U.S. Federal Regulations, Part 575 in accordance with the "National Traffic and Motor Vehicle Safety Act of 1966".

- ▶ **Step 1:** Locate the statement, "The combined weight of occupants and cargo should never exceed XXX kg or XXX lbs." ("Das kombinierte Gewicht von Insassen und Ladung sollte niemals XXX kg bzw. XXX lbs übersteigen") on the Tire and Loading Information placard of your vehicle.
- ▶ **Step 2:** Determine the combined weight of the driver and passengers who will be traveling in your vehicle.
- ▶ **Step 3:** Subtract the combined weight of the driver and passengers from XXX kg or XXX lbs.
- ▶ **Step 4:** The resulting figure equals the permissible load capacity for cargo and luggage. For example, if the "XXX" amount equals 1400 lbs and there will be five 150 lb passengers in your vehicle, the amount of available cargo and luggage load capacity is 650 lbs (1400 - 750 (5 x 150) = 650 lbs).
- ▶ **Step 5:** Determine the combined weight of any cargo and luggage being loaded into the vehi-

cle. For safety reasons, this weight must not exceed the permissible load capacity calculated in step 4.

- ▶ **Step 6:** If your vehicle is towing a trailer, load from the trailer is transferred to your vehicle. Consult these instructions in order to determine how this reduces the potential load and luggage capacity of your vehicle.

- ⓘ Note that not all vehicles are approved for trailer operation. Trailer operation is only permissible if a trailer hitch is installed and a towing capacity is specified in your vehicle documents. If in doubt, ask an authorized Mercedes-Benz dealer.

Even if you have calculated the total payload carefully, you should still make sure that the maximum permissible gross mass and the maximum permissible axle loads of your vehicle are not exceeded. Information for this can be found on the vehicle identification plate.

- ▶ Weigh the laden vehicle – including driver, passengers and payload – on a suitable vehicle weighbridge. The measured values must not exceed the maximum permitted values listed on the vehicle identification plate.

Additional related subjects:

- Sample calculation for determining the maximum payload (→ page 248)
- Tire and Loading Information placard (→ page 247)
- Tire pressure table (→ page 241)
- Vehicle identification plate (→ page 269)

Sample calculation for determining the maximum load

The following table has examples of how to calculate total and cargo load capacities with varying seating configurations and different numbers and sizes of occupants. The following examples use a maximum load of 1,500 lbs (680 kg). **This value is for illustrative purposes only.** Make sure you are using the actual load limit for your vehicle stated on your vehicle's Tire and Loading Information placard (→ page 247).

The higher the weight of all the occupants, the smaller the maximum load for luggage.

Step 1

	Example 1	Example 2
Combined maximum weight of occupants and load (data from the Tire and Loading Information placard)	1500 lbs (680 kg)	1500 lbs (680 kg)

Step 2

	Example 1	Example 2
Number of people in the vehicle (driver and occupants)	5	1
Distribution of the occupants	Front: 2 Rear: 3	Front: 1
Weight of occupants	Occupant 1: 150 lbs (68 kg) Occupant 2: 180 lbs (82 kg) Occupant 3: 160 lbs (73 kg) Occupant 4: 140 lbs (63 kg) Occupant 5: 120 lbs (54 kg)	Occupant 1: 200 lbs (91 kg)
Total weight of all occupants	750 lbs (340 kg)	200 lbs (91 kg)

Step 3

	Example 1	Example 2
Permissible load (maximum gross vehicle weight rating from the Tire and Loading Information placard minus the gross weight of all occupants)	1500 lbs (680 kg) - 750 lbs (340 kg) = 750 lbs (340 kg)	1500 lbs (680 kg) - 200 lbs (91 kg) = 1300 lbs (589 kg)

Tire labeling

Overview of tire labeling

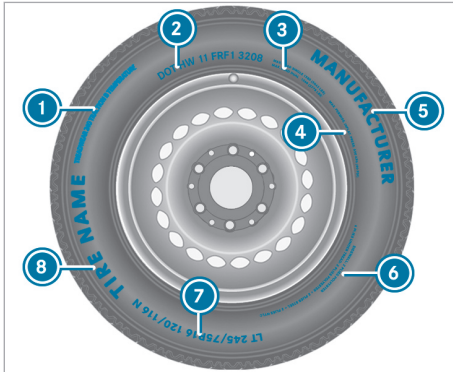

- ① Uniform Tire Quality Grading Standards (→ page 250)
- ② DOT (Department of Transportation), (TIN) Tire Identification Number (→ page 251)
- ③ Maximum tire load (→ page 251)
- ④ Maximum tire pressure (→ page 252)
- ⑤ Manufacturer
- ⑥ Characteristics of the tire (→ page 252)
- ⑦ Tire size designation, load-bearing capacity and speed rating (→ page 252)
- ⑧ Tire name
- ⓘ The data shown in the illustration is sample data.

Information on tire quality grades

According to the requirements of the U.S. Department of Transportation's "Uniform Tire Quality Grading Standards" tire manufacturers must grade their tires using the following three performance factors:

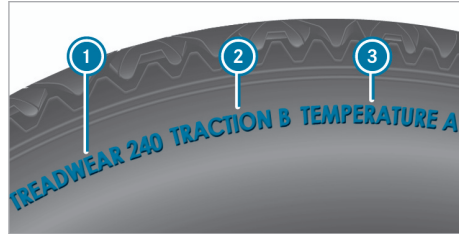

- ① Tread wear grade
- ② Traction grade
- ③ Temperature grade
- ⓘ The data shown in the illustration is sample data.
- ⓘ This grading is not legally prescribed for Canada, but specified in most cases anyway.

Tread wear grade

The tread wear grade is a comparative grading based on tread wear grade tests conducted under controlled conditions on a specified U.S. Department of Transportation test track. For example, a tire graded 150 would wear one and one-half times as well on the government test track as a tire graded 100.

The relative performance of tires depends upon the actual conditions of their use, however, and may depart significantly from the norm due to variations in driving habits, service practices and differences in road characteristics and climate conditions.

Traction grade

⚠ DANGER Risk of accident due to inadequate traction

The traction grade assigned to this tire is based on straight-ahead braking traction tests.

▶ Always adapt your driving style and drive at a speed to suit the prevailing traffic and weather conditions.

! NOTE Damage to the drivetrain from wheelspin

▶ Avoid wheelspin.

The traction grades – from highest to lowest – are AA, A, B and C. These grades relate to the tire's ability to come to a standstill on a wet pavement under controlled conditions on a specified U.S.

government test surface made from asphalt and concrete.

Temperature grade

⚠ WARNING Risk of accident from tire overheating and tire failure

Excessive speed, underinflation, or excessive loading, either separately or in combination, can cause excessive heat build-up and possible tire failure.

- ▶ Observe the recommended tire pressure.
- ▶ Regularly check the pressure of all the tires.
- ▶ Adjust the tire pressure, if necessary.

The temperature grades are A (highest grade), B and C. These relate to a tire's resistance to heat and its ability to release heat on a specified test wheel in laboratory tests under controlled conditions. Sustained high temperatures can cause the material of the tire to degenerate and reduce tire life. In addition, excessively high temperatures can lead to sudden tire failure. Grade C refers to a performance which all passenger vehicle tires must exhibit, according to the U.S. Department of Transportation's requirements.

Information on DOT and TIN (Tire Identification Number)

U.S. tire regulations indicate that every tire manufacturer or retreader must imprint a TIN in or on the sidewall of each tire produced.

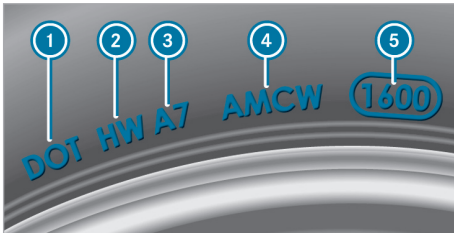

i The data shown in the illustration is sample data.

The TIN is a unique identification number for tires and consists of the following components:

- **DOT (Department of Transportation):** tire symbol **1** indicates that the tire complies with the

requirements of the U.S. Department of Transportation.

- **Manufacturer identification code:** manufacturer identification code **2** provides information about the tire manufacturer. New tires have a code with two symbols. Retreaded tires have a code with four symbols. For further information about retreaded tires, see (→ page 255).
- **Tire size:** identifier **3** describes the tire size.
- **Tire type code:** tire type code **4** can be used by the manufacturer as a code to describe specific characteristics of the tire.
- **Date of manufacture:** date of manufacture **5** provides information about the age of a tire. The 1st and 2nd numbers indicate the calendar week and the 3rd and 4th numbers indicate the year of manufacture (e.g. "3208" refers to the 32nd week of the year 2008).

Information on maximum tire load



i The data shown in the illustration is sample data.

Maximum tire load **1** is the maximum permissible weight for which the tire is approved.

Do not overload the tires by exceeding the maximum permissible load. The maximum permissible load can be found on the vehicle's Tire and Loading Information placard on the B-pillar on the driver's side (→ page 247).

Information on maximum tire pressure

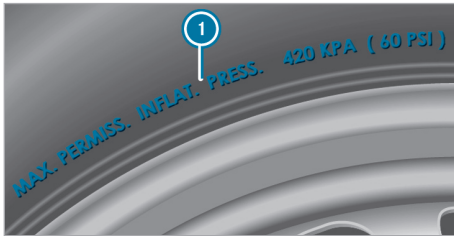

i The data shown in the illustration is sample data.

Maximum permitted tire pressure **1**, which is permitted for the tires must not be exceeded.

Exception: when using the 225/75 R16C 121/120R (122L) tires as a spare wheel on the rear axle of Super Single vehicles with a distance limit of 62 mi (100 km) and speed limit of 34 mph (55 km/h).

Information on tire characteristics



i The data shown in the illustration is sample data.

This information describes the type of tire cord and the number of layers in sidewall **1** and under tire tread **2**.

Tire size designation, load-bearing capacity and speed rating

⚠ WARNING Risk of injury through exceeding the specified tire load-bearing capacity or the permissible speed rating

Exceeding the specified tire load rating or the permissible speed rating may lead to tire damage and to the tires bursting.

► Therefore, only use tire types and sizes approved for your vehicle model.

► Observe the tire load rating and speed rating required for your vehicle.

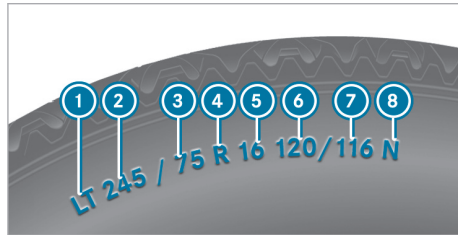

- 1** First letter(s)
- 2** Nominal tire width in millimeters
- 3** Aspect ratio in %
- 4** Tire code
- 5** Rim diameter
- 6** Load-bearing index, Single tires
- 7** Load-bearing index, twin tires
- 8** Speed rating

i The data shown in the illustration is sample data.

Further information about reading tire data can be obtained from any qualified specialist workshop.

First letter(s) **1**:

- "LT": light truck tires according to US manufacturing standards
- "C": tires for commercial usage in accordance with European manufacturer standards

Aspect ratio (in percent) **3**:

The size ratio between the tire height and tire width and is shown in percent (tire height divided by tire width).

Tire code **4** (tire type):

- "R": radial tire

Rim diameter **5**:

The diameter of the bead seat (not the diameter of the rim flange). The rim diameter is specified in inches (in).

Load-bearing index **6** and **7**:

Numerical code which specifies the maximum load-bearing capacity of a tire ("91" equals, e.g. 1,356 lb (615 kg)).

The tire load-bearing capacity must be at least half the permissible axle load of the vehicle. Do not overload the tires by exceeding the maximum permissible load of the tires.

See also:

- Maximum permissible load on the Tire and Loading Information placard (→ page 247)
- Maximum tire load (→ page 251)

Speed rating

Specifies the approved maximum design speed of the tire.

-  An electronic speed limiter prevents your vehicle from exceeding a speed of 130 mph (210 km/h).

Ensure that your tires have the required speed rating. You can obtain information on the required speed rating at an authorized Mercedes-Benz Center.

Summer tires

Index	Speed rating
L	Up to 75 mph (120 km/h)
M	Up to 81 mph (130 km/h)
N	Up to 87 mph (140 km/h)
P	Up to 93 mph (150 km/h)
Q	Up to 100 mph (160 km/h)
R	Up to 106 mph (170 km/h)

Summer, all-season and winter tires

Index	Speed rating
L M+S ¹	Up to 75 mph (120 km/h)
M M+S ¹	Up to 81 mph (130 km/h)
N M+S ¹	Up to 87 mph (140 km/h)
P M+S ¹	Up to 93 mph (150 km/h)

Index	Speed rating
Q M+S ¹	Up to 100 mph (160 km/h)
R M+S ¹	Up to 118 mph (170 km/h)

¹: Or "M+S  " for winter tires.

Winter tires are marked with the  snowflake symbol and fulfill the requirements of the Rubber Manufacturers Association (RMA) and the Rubber Association of Canada (RAC) regarding the tire traction on snow.

Information on definitions (tires and loading)

Tire structure and characteristics: describes the number of layers or the number of rubber-coated layers in the tire tread and the tire wall. These are made of steel, nylon, polyester and other materials.

Bar: metric unit for tire pressure. 14.5038 pounds per square inch (psi) and 100 kilopascals (kPa) are the equivalent of 1 bar.

DOT (Department of Transportation): DOT marked tires fulfill the requirements of the U.S. Department of Transportation.

Average weight of vehicle occupants: the number of occupants for which the vehicle is designed multiplied by 150 lbs (68 kg).

Uniform Tire Quality Grading Standards: a uniform standard to grade the quality of tires with regards to tread quality, tire traction and temperature characteristics. The quality grading assessment is made by the manufacturer in accordance with test specifications of the U.S. government. The quality grade of a tire is imprinted on the sidewall of the tire.

Recommended tire pressure: the recommended tire pressure is the pressure specified for the tires installed on the vehicle at the factory.

The Tire and Loading Information placard contains the recommended tire pressures for cold tires, the maximum permissible load and the maximum permissible vehicle speed.

The tire pressure table contains the recommended tire pressures for cold tires under various operating conditions, i.e. load and/or speed of the vehicle.

Increased vehicle weight due to optional equipment: the combined weight of all standard and

optional equipment available for the vehicle, regardless of whether it is actually installed on the vehicle or not.

Rim: the part of the wheel on which the tire is installed.

GAWR (Gross Axle Weight Rating): GAWR is the gross axle weight rating. The actual load on an axle must never exceed the Gross Axle Weight Rating. You can find the Gross Axle Weight Rating on the B-pillar on the driver's side.

Speed rating: the speed rating is part of the tire identification. It specifies the speed range for which a tire is approved.

GVW (Gross Vehicle Weight): the Gross Vehicle Weight includes the weight of the vehicle including fuel, tools, the spare wheel, accessories installed, occupants, luggage and the trailer drawbar nose-weight if applicable. The Gross Vehicle Weight must never exceed the Gross Vehicle Weight Rating (GVWR) specified on the B-pillar on the driver's side.

GVWR (Gross Vehicle Weight Rating): the GVWR is the maximum permitted gross weight of the fully laden vehicle (weight of the vehicle including all accessories, occupants, fuel, luggage and the trailer drawbar noseweight if applicable). The Gross Vehicle Weight Rating is specified on the vehicle identification plate on the B-pillar on the driver's side.

Maximum weight of the laden vehicle: the maximum weight is the sum of the vehicle's curb weight, weight of the accessories, maximum load and the weight of the factory-installed optional equipment.

Kilopascal (kPa): metric unit for tire pressure. 6.9 kPa are the equivalent of 1 psi. Another unit for tire pressure is bar. 100 kilopascals (kPa) are the equivalent of 1 bar.

Curb weight: the weight of a vehicle with standard equipment including the maximum capacity of fuel, oil and coolant. It also includes the air-conditioning system and optional equipment if these are installed on the vehicle, but does not include passengers or luggage.

Maximum tire load: the maximum tire load is the maximum permissible weight in kilograms or lbs for which a tire is approved.

Maximum permissible tire pressure: maximum permissible tire pressure for one tire.

Maximum load on one tire: maximum load on one tire. This is calculated by dividing the maximum axle load for one axle by two.

PSI (pounds per square inch): standard unit of measurement for tire pressure.

Aspect ratio: relationship between tire height and tire width in percent.

Tire pressure: pressure inside the tire applying outward force to every square inch of the tire's surface. The tire pressure is specified in pounds per square inch (psi), in kilopascals (kPa) or in bar. The tire pressure should only be corrected when the tires are cold.

Tire pressure of cold tires: the tires are cold when the vehicle has been parked with the tires out of direct sunlight for at least three hours and the vehicle has been driven less than 1 mile (1.6 km).

Tire contact surface: the part of the tire that comes into contact with the road.

Tire bead: the purpose of the tire bead is to ensure that the tire sits securely on the wheel rim. There are several wire cores in the tire bead to prevent the tire from changing length on the wheel rim.

Side wall: the part of the tire between the tread and the tire bead.

Special equipment weight: the combined weight of those optional extras that weigh more than the replaced standard parts and more than 5 lbs (2.3 kg). Special equipment, such as high-performance brakes, level control system, a roof luggage rack or a high-performance battery, are not included in the curb weight and the weight of the accessories.

TIN (Tire Identification Number): a unique identification number which can be used by a tire manufacturer to identify tires, for example, in a product recall, and thus identify the purchasers. The TIN is made up of the manufacturer identification code, tire size, tire type code and the manufacturing date.

Load-bearing index: the load-bearing index (also load index) is a code that contains the maximum load-bearing capacity of a tire.

Traction: traction is the result of friction between the tires and the road surface.

Wear indicator: narrow bars (tread wear bars) that are distributed over the tire tread. If the tire tread is level with the bars, the wear limit of 1/16 in (1.6 mm) has been reached.

Distribution of vehicle occupants: distribution of vehicle occupants over designated seat positions in a vehicle.

Maximum permissible payload weight: nominal load and luggage load plus 150 lbs (68 kg) multiplied by the number of seats in the vehicle.

Changing a wheel

Notes on selecting, installing and replacing tires

You can obtain information regarding permissible wheel/tire combinations at a qualified specialist workshop.

⚠ WARNING Risk of accident due to incorrect wheel and tire dimensions

If wheels and tires of the wrong size are used, the service brakes or wheel suspension components may be damaged.

- ▶ Always replace wheels and tires with ones that fulfill the specifications of the original part.

For wheels, pay attention to the following:

- Designation
- Type
- Permissible wheel load
- Wheel offset

For tires, pay attention to the following:

- Designation
- Manufacturer
- Type
- Load-bearing index
- Speed rating

⚠ WARNING Risk of injury through exceeding the specified tire load-bearing capacity or the permissible speed rating

Exceeding the specified tire load rating or the permissible speed rating may lead to tire damage and to the tires bursting.

- ▶ Therefore, only use tire types and sizes approved for your vehicle model.
- ▶ Observe the tire load rating and speed rating required for your vehicle.

❗ NOTE Vehicle and tire damage due to tire types and sizes that have not been approved

For safety reasons, only use tires, wheels and accessory parts which have been specially approved by Mercedes-Benz for your vehicle.

These tires have been specially adapted for use with driving systems and driving safety systems, such as ABS or ESP®.

Otherwise, certain properties, such as handling characteristics, vehicle noise emissions and consumption could be adversely affected. Other wheel sizes may cause the tires to come into contact with the vehicle body and axle components when under load. This may result in damage to the tire or the vehicle.

- ▶ Only use tires, wheels and accessory parts that have been checked and recommended by Mercedes-Benz.

❗ NOTE Driving safety put at risk by retreaded tires

Retreaded tires are not checked or recommended by Mercedes-Benz, as previous damage is not always detected during the retread process.

Driving safety cannot, therefore, be guaranteed.

- ▶ Do not use used tires when their previous usage is unknown.

Accessories that are not approved for your vehicle by Mercedes-Benz, or are not being used correctly, can impair operating safety.

Before purchasing and using non-approved accessories, visit a qualified specialist workshop and inquire about:

- suitability
- legal provisions
- factory recommendations

Observe the following points when selecting, installing and replacing tires:

- Use only tyres and wheels of the same type, design (winter tyres, all-season tyres) and make.
- Only install wheels of the same size and tread pattern on one axle (left and right).

It is only permissible to deviate from this in the event of a flat tire to drive to the specialist workshop.

- Only install tires of the correct size on the wheels.
- **Vehicles with a tire pressure monitoring system:** all installed wheels must be equipped with functioning sensors for the tire pressure monitoring system.
- At temperatures below 50 °F (10 °C), use winter tires or all-season tires marked M+S on all wheels.

Winter tires bearing the  snowflake symbol in addition to the M+S marking provide the best possible grip in wintry road conditions.

- Only use tires with the same tread pattern.
- Observe the maximum permissible speed for the mounted tires.
If this is below the vehicle's maximum permissible speed, this must be indicated on a label in the driver's field of vision.
- Break in new tires at moderate speeds for the first 60 miles (100 km).
- Replace the tires after six years at the latest, regardless of wear.

For more information on wheels and tires, contact a qualified specialist workshop.

i Vehicles with twin tires:

For vehicles with twin tires and a GVWR of 11,030 lbs or 12,125 lbs, only use tires of size LT 215/85 R16 that have been approved for this vehicle by the manufacturer. It is not permissible to use tires of different dimensions; doing so may lead to the general operating permit being rendered invalid.

i Vehicles with single tires:

For vehicles with single tires and a GVWR of less than or equal to 9,480 lbs, only use tires of size LT 245/75 R16 that have been approved for this vehicle by the manufacturer. It is not permissible to use tires of different dimensions; doing so may lead to the general operating permit being rendered invalid.

i Vehicles with super-single tires:

For vehicles with single tires with a GVWR of 11,030 lbs, only use tires of sizes 225/75 R16C (FA) and 285/65 R16C (RA) that have been approved for this vehicle by the manufacturer. It is not permissible to use tires of different dimensions; doing so may lead to

the general operating permit being rendered invalid.

Also observe the following further related subjects:

- Notes on tire pressure (→ page 240)
- Tire and Loading Information placard (→ page 247)
- Tire size designation, load capacity and speed rating (→ page 252)
- Tire pressure table (→ page 241)
- Notes on the emergency spare wheel (→ page 262)

Notes on changing wheels

⚠ WARNING Risk of injury through different wheel sizes

Rotating the front and rear wheels can severely impair the driving characteristics.

The wheel brakes or suspension components may also be damaged.

- ▶ Rotate front and rear wheels only if the wheels and tires are of the same dimensions.

On vehicles that have the same size front and rear wheels, rotate the wheels according to the intervals in the tire manufacturer's warranty book in your vehicle documents. If this is not available, rotate the tires every 3,000 (5,000) to 6,000 miles (10,000 km), depending on the degree of wear. Ensure that the direction of rotation is maintained.

It is imperative to observe the instructions and safety notes on "Changing a wheel" when doing so.

Information on the direction of the tires' rotation

Tires with a specified direction of rotation have additional benefits, e.g. if there is a risk of hydroplaning. You will only gain these benefits if the correct direction of rotation is observed.

An arrow on the sidewall of the tire indicates its correct direction of rotation.

You may also install a spare wheel against the direction of rotation. Observe the time restriction on use as well as the speed limitation specified on the spare wheel.

Notes on storing wheels

Observe the following when storing wheels:

- Wheels that have been removed should be stored in a cool, dry and, if possible, dark place.
- Protect the tires from oil, grease and fuel.

Overview of tire-change tool kit

Required tire-changing tools may include, for example:

- Jack
- Wheel wrench

- i** You will find the maximum load capacity of the jack stated on the adhesive label attached to the jack.
The jack is maintenance-free. If there is a malfunction, please contact a qualified specialist workshop.

Vehicles with rear wheel drive

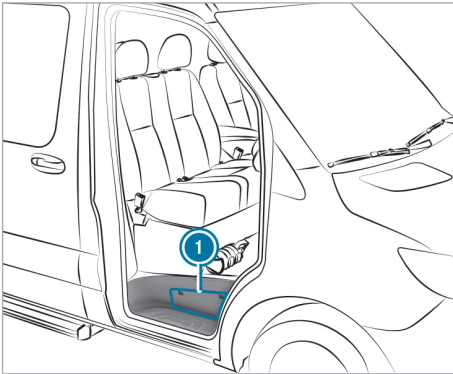

The tire-change tool kit is located in storage compartment ① above the step of the front passenger door and in the storage compartment in the footwell on the front passenger side.

Preparing the vehicle for a wheel change

Requirements

- The tire-change tool kit is available.
- The vehicle is not on a slope.
- The vehicle is on solid, non-slippery and level ground.

- ▶ Apply the parking brake.

- ▶ Move the front wheels to the straight-ahead position.
- ▶ **Vehicles with automatic transmission:** shift to transmission position **P**.
- ▶ Switch off the vehicle.
- ▶ Make sure that the vehicle cannot be switched on.
- ▶ Take the vehicle tool kit from the footwell on the front passenger side (→ page 235).

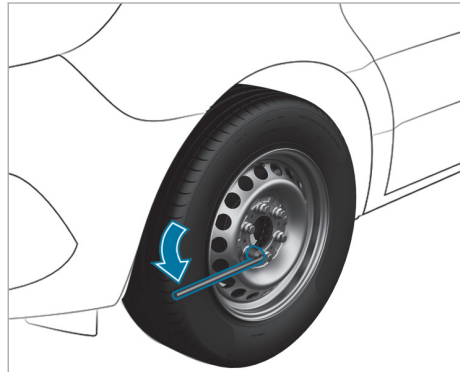

Vehicles with rear-wheel drive

- ▶ Take the jack and the tire-change tool kit out of the storage compartment (→ page 257).
- ▶ If necessary, remove the wheel trim.
- ▶ Assemble the wheel wrench extension using the middle rod and the rod with the largest diameter from the three-piece jack pump lever.
- ▶ Starting with the middle rod, slide the wheel wrench extension as far as it will go onto the wheel wrench.
- ▶ Use the wheel wrench to loosen the wheel nuts or bolts on the wheel you wish to change by about one full turn. Do not unscrew the wheel nuts or bolts completely.
- ▶ Raise the vehicle (→ page 257).

3^^Raising the vehicle when changing a wheel

▲ WARNING Risk of injury due to the jack tipping over

If you park a vehicle with air suspension, the air suspension can remain active for up to an hour, even if the vehicle is switched off. If you then raise the vehicle using the jack, the air

suspension will attempt to even out the vehicle level.

The jack can tip over.

- ▶ Before raising the vehicle, press the Service button on the remote control for the air suspension. This prevents the vehicle level from being automatically readjusted or manually raised or lowered.

⚠ WARNING Risk of injury from incorrect positioning of the jack

If you do not position the jack correctly at the appropriate jacking point of the vehicle, the jack could tip with the vehicle raised.

- ▶ Only position the jack at the appropriate jacking point of the vehicle. The base of the jack must be positioned vertically under the jacking point of the vehicle.

⚠ WARNING Risk of injury from vehicle tipping

On slopes, the jack could tip with the vehicle raised.

- ▶ Never change a wheel on a slope.
- ▶ Consult a qualified specialist workshop.

! NOTE Damage to the vehicle due to the jack

If you do not position the jack at the jack support points provided for this purpose, you could damage your vehicle.

- ▶ Only position the jack at the jack support points provided for this purpose.

Requirements

- There is nobody in the vehicle.
- The vehicle is prepared for changing a wheel (→ page 257).

Only position the jack on the jack support points intended for this purpose. Otherwise you could damage the vehicle.

Important notes on using the jack:

- Only use the vehicle-specific jack that has been tested and approved by Mercedes-Benz to raise the vehicle. If the jack is used incor-

rectly, it could tip over while the vehicle is raised.

- The jack is designed only to raise the vehicle for a short time while a wheel is being changed and is not suitable for carrying out maintenance work under the vehicle.
- Avoid changing a wheel on uphill or downhill slopes.
- The jack must be placed on a firm, flat and non-slip surface. If necessary, use a large, flat, load-bearing and non-slip support.
- The base of the jack must be positioned vertically under the jack support point.

Safety instructions while the vehicle is raised:

- Do not put your hands or feet under the vehicle.
- Do not lie underneath the vehicle.
- Do not start the vehicle and do not release the parking brake.
- Do not open or close any doors.

Vehicles with rear-wheel drive

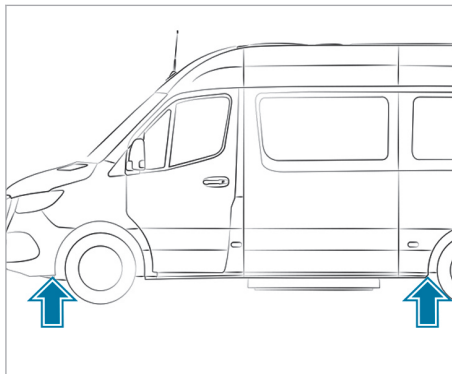

Jack support points

Only use the middle rod and the pump handle rod with the largest diameter for the jack as a wheel wrench extension. Only fit the middle rod on the wheel wrench, and always as far as it will go. Otherwise, the rods could bend and deform so much that they can no longer be used as pump handles for the jack.

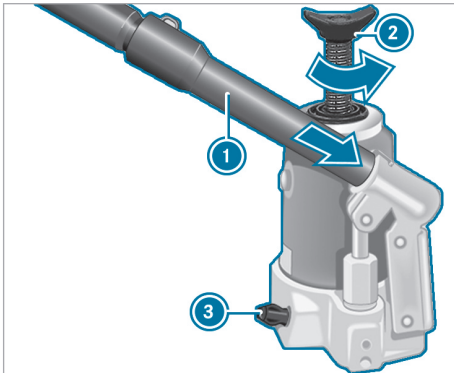

- ▶ **To prepare the hydraulic jack:** Insert the third rod of the jack's pump handle ① into the wheel wrench extension.
 - ▶ Close the pressure release screw ③.
 - ▶ To do this, use the flattened section on the pump handle ① to turn the pressure release screw ③ clockwise to the stop.
- i** Do not turn the pressure release screw ③ more than one or two full turns. Hydraulic fluid could otherwise escape.
- ▶ Insert the pump handle ① with the largest rod pointing forward into the recess on the jack and secure by turning it clockwise.
 - ▶ Place the jack vertically beneath the jack support points described below.

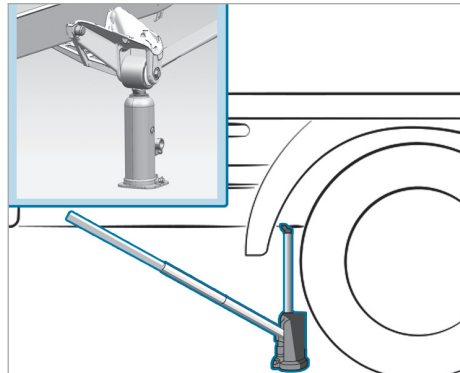

Jack support point, rear axle (example: chassis up to 3.5 t)

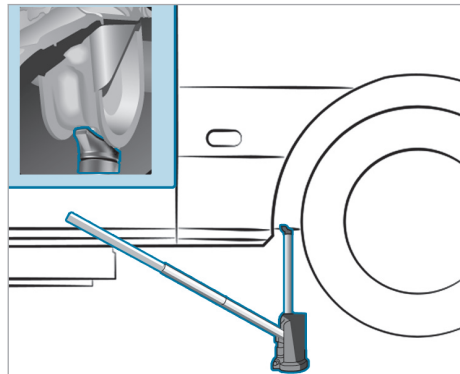

Jack support point, rear axle (example: panel van and crewbus up to 4.0 t)

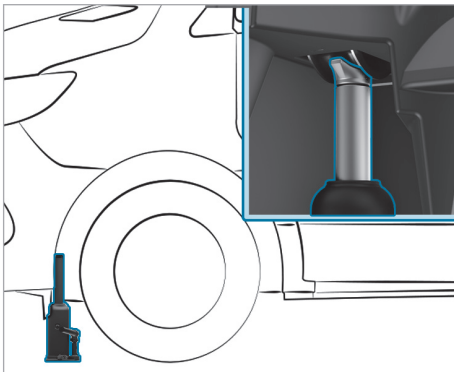

Jack support point, front axle

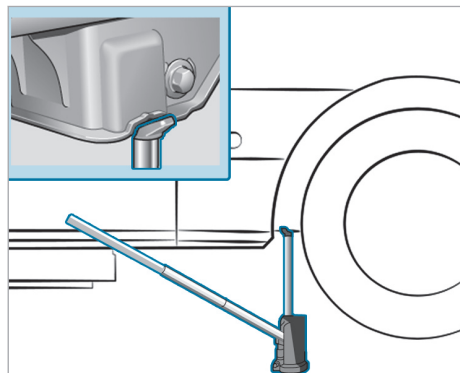

Jack support point, rear axle (5.0 t vehicles)

- ▶ Place the jack beneath the jack support point.

- ▶ **Vehicles with all-wheel drive:** Turn the jack spindle ② counter-clockwise as far as it will go.
- ▶ Raise the vehicle until the tire is a maximum of 1.2 in (3 cm) off the ground.
- ▶ Loosen and remove the wheel (→ page 260).

Removing a wheel

Requirements:

- The vehicle is raised (→ page 257).

When changing a wheel, avoid applying any force to the brake discs since this could impair the level of comfort when braking.

! **NOTE** Damage to threading from dirt on wheel bolts

▶ Do not place wheel bolts in sand or on a dirty surface.

- ▶ Unscrew the wheel bolts or nuts with the wheel nut wrench.
- ▶ On front wheels with wheel nuts, remove the wheel nut cover.
- ▶ Remove the wheel.

installing a new wheel

Requirements

- The wheel is approved (→ page 260).

! **WARNING** Risk of accident from losing a wheel

Oiled, greased or damaged wheel bolt/wheel nut threads or wheel hub/wheel mounting bolt threads can cause the wheel bolts/wheel nuts to come loose.

- ▶ Never oil or grease the threads.
- ▶ In the event of damage to the threads, contact a qualified specialist workshop immediately.
- ▶ Have the damaged wheel bolts or damaged hub threads replaced.
- ▶ Do not continue driving.

! **WARNING** Risk of injury from tightening wheel bolts and nuts

If you tighten the wheel bolts or wheel nuts when the vehicle is raised, the jack could tip.

▶ Only tighten wheel bolts or wheel nuts when the vehicle is on the ground.

- ▶ Observe the information on the choice of tires (→ page 255).
- ▶ Observe the instructions and safety notes on changing a wheel (→ page 255).
- ▶ For safety reasons, only use wheel bolts or wheel nuts which have been approved by Mercedes-Benz and for the wheel in question.

When you install the steel spare wheel, it is essential to use the short wheel bolts for a steel wheel. Using other wheel bolts when installing the steel spare wheel may damage the brake system.

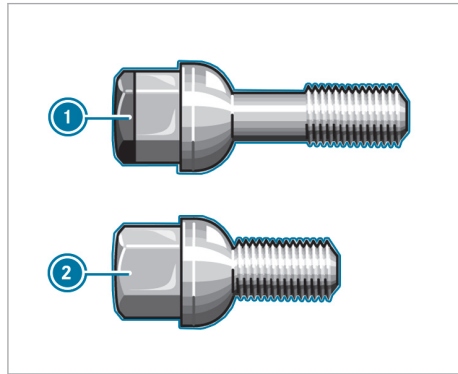

- ① Wheel bolt for light-alloy wheel
- ② Wheel bolt for steel wheel

- ▶ Clean the wheel and wheel hub contact surfaces.
- ▶ **Vehicles with ultrawide-base tires:** first install the adapter for the more narrow spare wheel on the wheel hub.
- ▶ Slide the wheel which is to be installed onto the wheel hub or the adapter for the spare wheel and push it on.

Vehicles with steel wheels

- ▶ Use the short wheel bolts intended for the steel spare wheel, which are found in the vehicle tool kit.
- ▶ Screw in the wheel bolts until they are hand-tight.

Vehicles with light alloy wheels

- ▶ Use the long wheel bolts intended for the light-alloy spare wheel, which are found in the vehicle tool kit.
- ▶ Screw in the wheel bolts until they are hand-tight.

Wheels with wheel nuts

- ▶ Front wheels with wheel nut cover: press the wheel nut cover onto the wheel nuts.
- ▶ Screw in three wheel nuts over the fixing discs of the wheel nut cover.
- ▶ Turn the wheel so that the wheel bolts are centered in the holes.
- ▶ Screw in the remaining wheel nuts.
- ▶ Slightly tighten all the wheel nuts.

Lowering the vehicle after a wheel change

⚠ WARNING Risk of accident due to incorrect tightening torque

The wheels could come loose if the wheel bolts or wheel nuts are not tightened to the prescribed torque.

- ▶ Ensure that the wheel bolts or wheel nuts are tightened to the prescribed tightening torque.
- ▶ If you are not sure, do not move the vehicle. Contact a qualified specialist workshop and have the tightening torque checked immediately.

Requirements:

- The new wheel has been installed (→ page 260).

Observe the notes on raising the vehicle (→ page 257).

Vehicles with rear wheel drive

Only use the middle rod and the pump lever rod with the largest diameter for the jack as a lug wrench extension. Only insert the middle rod on the lug wrench, and always as far as it will go. Otherwise, the rods could bend and deform so much that they can no longer be used as pump levers for the jack.

Vehicles with Super Single tires: if you mount the spare wheel on the rear axle, do not exceed the maximum speed of 34 mph (55 km/h) and the maximum distance of 62 miles (100 km). Other-

wise, the rear axle differential could be damaged due to the different wheel speeds.

- ▶ Using the pump lever, slowly turn the drain screw on the jack approximately one revolution and carefully lower the vehicle.
- ▶ Place the jack to one side.
- ▶ Pull the rod with the smallest diameter off the pump lever. The shortened pump lever serves as a lug wrench extension.
- ▶ Starting with the middle rod, slide the lug wrench extension as far as it will go onto the lug wrench.

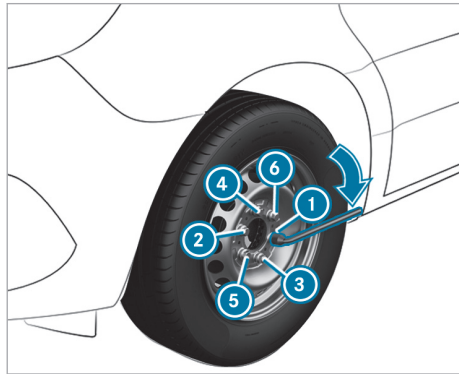

- ▶ Tighten the wheel bolts or nuts evenly in the sequence indicated (1 to 6).

Specified tightening torque:

- Steel wheel bolts: 177 lb-ft (240 Nm)
- Wheel nuts: 133 lb-ft (180 Nm)
- Alloy wheel bolts: 133 lb-ft (180 Nm)

- ▶ Push the piston on the hydraulic jack in again and close the pressure release screw.

- ▶ **Vehicles with all-wheel drive:** turn the jack spindle clockwise as far as it will go.

- ▶ **i** You can now install the hub caps on steel wheels with wheel bolts. The installation procedure depends on whether the hub cap acts as a trim that covers the whole wheel, or just covers the center.

- ▶ **Wheel with wheel trim:** position the opening in the wheel trim for the tire valve over the tire valve.

- ▶ Push the edge of the hub cap onto the wheel rim with both hands until it engages into place.

Make sure the hub cap retaining catches engage on the steel wheel.

- ▶ **Wheel with central hub cap:** position the retaining lugs of the central hub cap over the wheel bolts.
- ▶ Hit the middle of the hub cap to engage it on the wheel.
- ▶ Secure the faulty wheel in the spare wheel holder.
- ▶ **Vehicles with Super Single tires:** transport the malfunctioning rear wheel in the load area. The rear wheel is too large for the spare wheel holder.
- ▶ Check the tire pressure of the newly installed wheel and adjust it if necessary.
- ▶ Retighten the wheel bolts or wheel nuts to the specified tightening torque after the vehicle has been driven 31 miles (50 km).
- ▶ When using a wheel or spare wheel with a new or newly painted wheel rim, have the wheel bolts or wheel nuts retightened after approximately 620 miles (1,000 km) to 3,100 miles (5,000 km).

i **Vehicles with a tire pressure monitoring system:** all installed wheels must be equipped with functioning sensors.

Make sure to observe the following further related subject:

- Notes on tire pressure (→ page 240)

Spare wheel

Notes on the emergency spare wheel and spare wheel

Emergency spare wheel: wheel and/or tire dimensions as well as the type of tire are different from the wheel to be replaced.

i A label with the speed limitation can be found on the emergency spare wheel.

Spare wheel: wheel and tire dimensions as well as the type of tire correspond to the other installed wheels.

An installed emergency spare wheel or spare wheel changes the driving characteristics and bears risks.

⚠ WARNING Risk of accident due to incorrect wheel and tire dimensions

Mounting an emergency spare wheel or spare wheel may severely impair the driving characteristics.

There is an increased risk of an accident.

To prevent hazardous situations:

- ▶ Check the tire pressure of the spare wheel or emergency spare wheel once installed and, if necessary, adjust.
- ▶ The emergency spare wheel may only be used temporarily and must be replaced with a standard wheel as soon as possible.
- ▶ Never install more than one emergency spare wheel.
- ▶ Adapt your driving style and drive carefully in emergency spare wheel mode.
- ▶ Do not switch off ESP®.
- ▶ Do not use snow chains on the emergency spare wheel.
- ▶ Replace the emergency spare wheel after six years at the latest, regardless of wear.

- When using an emergency spare wheel or spare wheel (different from the wheel to be replaced), you must not exceed a permissible top speed of 50 mph (80 km/h).
- Have the emergency spare wheel or spare wheel replaced by a qualified specialist workshop (→ page 255).
- The tire pressure of the emergency spare wheel or spare wheel must be checked before starting a journey and, if necessary, adjusted (→ page 241).

⚠ WARNING Risk of accident due to damaged spare wheel with Super Single tires

Vehicles with Super Single tires

If you exceed the maximum speed or maximum distance, or re-install the spare wheel, its tire could be undetectably damaged and cause tire pressure loss.

You could lose control of the vehicle.

- ▶ Only use the spare wheel if it has not yet been installed on the rear axle with the current tire.
- ▶ If the spare wheel has been installed on the rear axle, have the tire of the spare

wheel replaced after changing the wheel again.

- ▶ For safety reasons, when changing a tire ensure that only the tire valve type approved for the tires is used.

! **NOTE** Damage to the rear axle differential due to differing wheel speeds

Vehicles with Super Single tires: when you install the spare wheel on the rear axle, the rear axle differential may be damaged by the different wheel speeds.

- ▶ When the spare wheel is installed on the rear axle, observe the maximum speed of 34 mph (55 km/h) and a maximum driving distance of 62 mi (100 km).

- i** It is possible to use the spare wheel without restrictions only on the front axle of a vehicle with Super single tires.

The following should be checked regularly, particularly prior to long journeys:

- that the emergency spare wheel or spare wheel is firmly secured
- the tire pressure of the emergency spare wheel or spare wheel (adjust the tire pressure if necessary) (→ page 241)
- the fastenings of the emergency spare wheel holder or spare wheel holder

The spare wheel is located either in the load compartment or in a spare wheel holder under the vehicle.

Replace the tires after six years at the latest, regardless of wear. This also applies to the spare wheel.

- i** If you have installed an emergency spare wheel or a spare wheel, the tire pressure monitoring system will not function for this wheel. The emergency spare wheel or spare wheel is not equipped with a sensor for the tire pressure monitoring system.

installing and removing the spare wheel

Vehicles with rear-wheel drive: removing the spare wheel (panel van or crewbus)

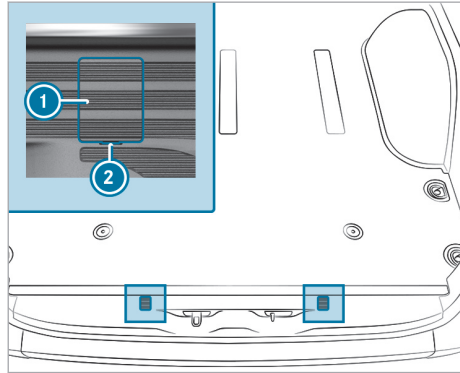

Bolt covers for the retaining hooks (example: panel van)

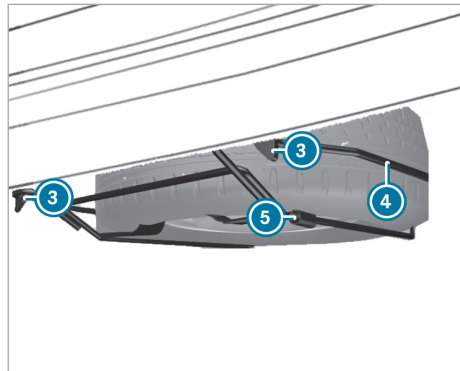

- ▶ Open the rear doors.
- ▶ Insert a screwdriver into the recesses **2** and pry off the covers **1**.
- ▶ Using the lug wrench from the vehicle tool kit, turn the now visible bolts counter-clockwise by approximately 20 turns.
- ▶ Slightly raise the spare wheel carrier **4** and unhook the left-hand retaining hook **3**.
- ▶ Assemble the pump lever for the jack and slide it into the sleeve **5** on the right-hand side of the spare wheel carrier **4**.
- ▶ Raise the spare wheel carrier **4** with the pump lever and unhook the right-hand retaining hook **3**.

- ▶ Slowly lower the spare wheel carrier ④ to the ground.
- ▶ Lift the spare wheel carrier ④ slightly and pull the pump lever out of the sleeve.
- ▶ Use the pump lever to lift the spare wheel beyond the rear edge of the spare wheel carrier ④.
- ▶ Carefully remove the spare wheel from the spare wheel carrier ④. The spare wheel is heavy. When the spare wheel is removed, the center of gravity changes owing to the heavy weight of the wheel. The spare wheel may slip down or tip over.

Vehicles with rear-wheel drive: installing the spare wheel (panel van or crewbus)

- ▶ Carefully place the spare wheel onto the spare wheel carrier ④. The spare wheel is heavy. When you place the spare wheel onto the spare wheel carrier ④, the center of gravity changes owing to the weight of the wheel. The spare wheel may slip down or tip over.
- ▶ Slide the pump lever for the jack into the sleeve ⑤ on the spare wheel carrier ④.
- ▶ Raise the spare wheel carrier ④ with the pump lever and attach the right-hand retaining hook ③.
- ▶ Slightly raise the spare wheel carrier ④ and attach the left-hand retaining hook ③.
- ▶ Pull the pump lever out of the sleeve ⑤.
- ▶ Using the lug wrench, tighten the bolts for the retaining hooks ③ by turning them clockwise.
- ▶ Attach and snap in the covers ①.
- ▶ Close the rear doors.

Vehicles with rear-wheel drive: removing the spare wheel (vehicle with lowered chassis)

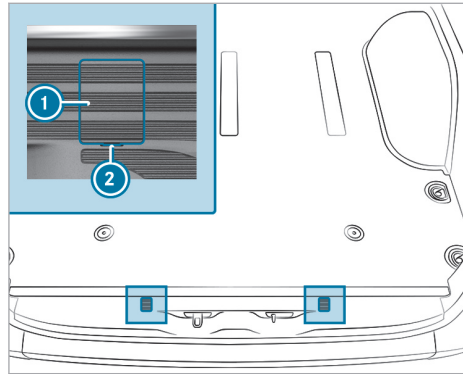

Bolt covers for the retaining hooks (example: panel van)

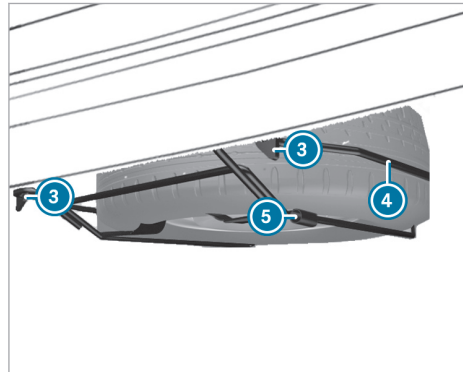

- ▶ Open the rear doors.
- ▶ Insert a screwdriver into the recesses ② and pry off the covers ①.
- ▶ Using the lug wrench from the vehicle tool kit, turn the now visible bolts counter-clockwise by approximately 20 turns.
- ▶ Slightly raise the spare wheel carrier ④ and unhook the left-hand retaining hook ③.
- ▶ Assemble the pump lever for the jack and slide it into the sleeve ⑤ on the right-hand side of the spare wheel carrier ④.
- ▶ Raise the spare wheel carrier with the pump lever and unhook the right-hand retaining hook ③.
- ▶ Prepare the jack.

- ▶ Place the jack beneath the corresponding jack support point.
- ▶ Move the pump lever up and down until the tire is raised a maximum of 1.18 in (3 cm) off the ground.
- ▶ Carefully remove the spare wheel from the spare wheel carrier ④. The spare wheel is heavy. When the spare wheel is removed, the center of gravity changes owing to the heavy weight of the wheel. The spare wheel may slip down or tip over.
- ▶ install the spare wheel on the vehicle.
- ▶ Lower the vehicle.

Vehicles with rear-wheel drive: installing the spare wheel (vehicle with lowered chassis)

- ▶ **i** In the event of a flat tire, you may only place the defective wheel inside the vehicle. An intact wheel may be stored in the spare wheel carrier only when the vehicle is unladen. A laden vehicle must first be raised.
- ▶ Carefully place the spare wheel onto the spare wheel carrier ④. The spare wheel is heavy. When you place the spare wheel onto the spare wheel carrier ④, the center of gravity changes owing to the weight of the wheel. The spare wheel may slip down or tip over.
- ▶ Slide the pump lever for the jack into the sleeve ⑤ on the spare wheel carrier ④.
- ▶ Raise the spare wheel carrier ④ with the pump lever and attach the right-hand retaining hook ③.
- ▶ Slightly raise the spare wheel carrier ④ and attach the left-hand retaining hook ③.
- ▶ Pull the pump lever out of the sleeve ⑤.
- ▶ Using the lug wrench, tighten the bolts for the retaining hooks ③ by turning them clockwise.
- ▶ Attach and snap in the covers ①.
- ▶ Close the rear doors.

Vehicles with rear-wheel drive: removing the spare wheel (chassis)

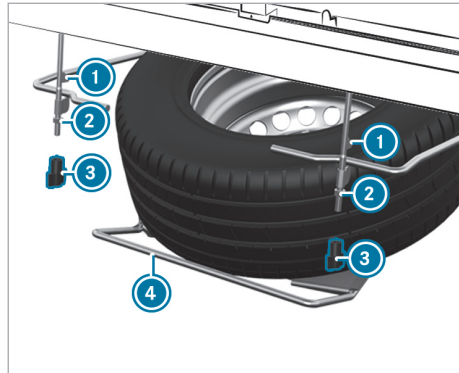

- ▶ Loosen the wing nuts ③ manually and remove them.
- ▶ Loosen the nuts ② to the thread end.
- ▶ Slightly raise the spare wheel carrier ④ and unhook the left-hand retaining hook ①.
- ▶ Assemble the pump lever for the jack and slide it into the sleeve on the right-hand side of the spare wheel carrier ④.
- ▶ Raise the spare wheel carrier ④ with the pump lever and unhook the right-hand retaining hook ①.
- ▶ Slowly lower the spare wheel carrier ④ to the ground.
- ▶ Lift the spare wheel carrier ④ slightly and pull the pump lever out of the sleeve.
- ▶ Use the pump lever to lift the spare wheel beyond the rear edge of the spare wheel carrier.
- ▶ Carefully remove the spare wheel from the spare wheel carrier. The spare wheel is heavy. When the spare wheel is removed, the center of gravity changes owing to the heavy weight of the wheel. The spare wheel may slip down or tip over.

Vehicles with rear-wheel drive: installing the spare wheel (chassis)

- ▶ Carefully place the spare wheel onto the spare wheel carrier ④. The spare wheel is heavy. When you place the spare wheel onto the spare wheel carrier, the center of gravity changes owing to the weight of the wheel. The spare wheel may slip down or tip over.

- ▶ Slide the pump lever for the jack into the sleeve on the spare wheel carrier ④.
- ▶ Raise the spare wheel carrier ④ with the pump lever and attach the right-hand retaining hook ①.
- ▶ Slightly raise the spare wheel carrier and attach the left-hand retaining hook ①.
- ▶ Pull the pump lever out of the sleeve.
- ▶ Tighten the nuts ②.
- ▶ Start the wing nuts ③ and tighten them.

Information on the technical data

The given data only applies to vehicles with standard equipment. You can obtain further information at a qualified specialist workshop.

On-board electronics

Notes on work on the engine electronics

! **NOTES** Premature wear through improper maintenance

Improper maintenance may cause vehicle components to wear more quickly and the vehicle's operating permit may be invalidated.

- ▶ Always have work on the engine electronics and related components carried out at a qualified specialist workshop.

Two-way radios

Installation notes for two-way radios

⚠ **WARNING** Risk of accident due to improper work on two-way radios

If two-way radios are manipulated or retrofitted incorrectly, the electromagnetic radiation from the two-way radios can interfere with the vehicle electronics and jeopardize the operating safety of the vehicle.

- ▶ You should have all work on electrical and electronic components carried out at a qualified specialist workshop.

⚠ **WARNING** Risk of accident due to improper operation of two-way radios

If you use two-way radios in the vehicle improperly, their electromagnetic radiation can disrupt the vehicle's electronics. This is the case in the following situations, in particular:

- The two-way radio is not connected to an exterior antenna.
- The exterior antenna is installed incorrectly or is not a low-reflection antenna.

This could jeopardize the operating safety of the vehicle.

- ▶ Have the low-reflection exterior antenna installed at a qualified specialist workshop.

- ▶ When operating two-way radios in the vehicle, always connect them to the low-reflection exterior antenna.

! **NOTE** Invalidation of the operating permit due to failure to comply with the instructions for installation and use

The operating permit may be invalidated if the instructions for installation and use of two-way radios are not observed.

- ▶ Only use approved frequency bands.
- ▶ Observe the maximum permissible output power in these frequency bands.
- ▶ Only use approved antenna positions.

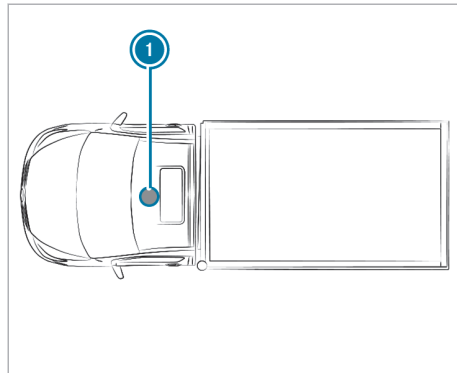

Cab Chassis (standard cab)

① Front roof area

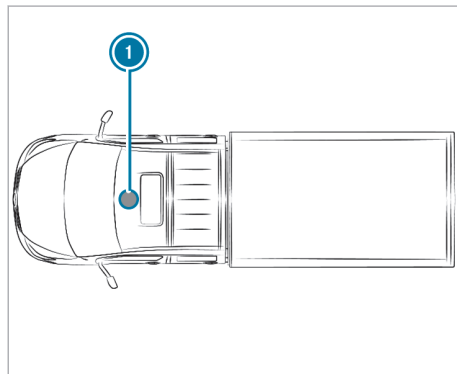

Cab Chassis (crewcab)

① Front roof area

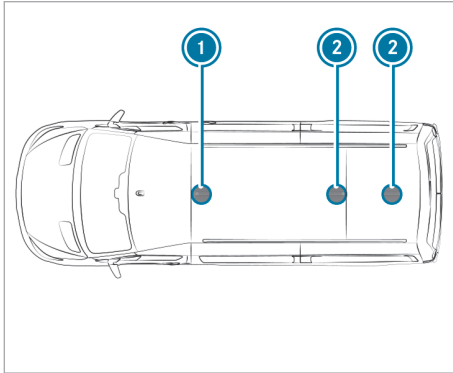

Cargo Van

- ① Front roof area
- ② Rear roof area

Use Technical Specification ISO/TS 21609 (Road Vehicles - EMC guidelines for installation of after-market radio frequency transmitting equipment) when retrofitting two-way radios. Comply with the legal requirements for detachable parts.

If your vehicle has pre-installation for two-way radio equipment, use the power supply or antenna connections intended for use with the pre-installation. Observe the manufacturer's supplements during installation.

Transmission output of two-way radios

The maximum transmission outputs (PEAK) at the base of the antenna must not exceed the values in the following table:

Frequency band and maximum transmission output

Frequency band	Maximum transmission output
2 -m- frequency band 144 - 174 MHz	50 W
4-m-frequency band 74 - 88 MHz	30 W
Terrestrial Trunked Radio (TETRA) 380 - 460 MHz	10 W

Frequency band	Maximum transmission output
Mobile telephony 2G	2 W
Mobile telephony 3G/4G/5G	0.5 W

There are no restrictions on use of the following devices in the vehicle:

- Two-way radios with a maximum transmission output of up to 100 mW
- Two-way radios with transmitter frequencies in the 380–410 MHz frequency band and a maximum transmission output of up to 2 W (trunked radio system/Tetra)
- Mobile phones (2G/3G/4G/5G)

There are no restrictions on positioning the antenna on the outside of the vehicle for the following frequency bands:

- Terrestrial Trunked Radio (TETRA)
- 2G/3G/4G/5G

Radio regulations

Regulatory radio identifiers and specific notes

Manufacturer information about radio-based vehicle components can be found using the key phrase "Regulatory radio information" in the Digital Operator's Manual in the vehicle, on the internet and in the app.

Further information and updates are available at the following web address:

<https://regulatoryradioinformation.corpinter.net/vans/us>



Information about the specific absorption rate (SAR)

Information about the specific absorption rate (SAR) can be found using the key phrase "Regulatory radio information" in the Digital Operating Instructions in the vehicle, on the internet and in the app.

Further information and updates are available at the following web address:

<https://regulatoryradioinformation.corpinter.net/vans/us>



Vehicle identification plate, vehicle identification number (VIN) and engine number

Vehicle identification plate

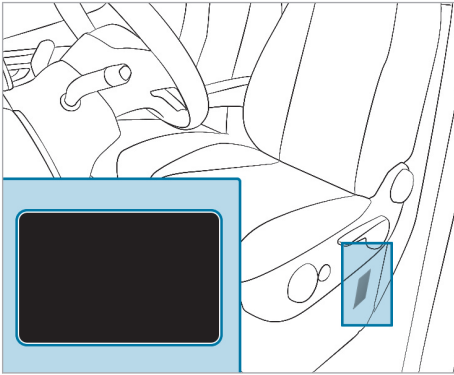

Depending on the vehicle model, the vehicle identification plate is located on the seat box of the driver's seat or on the B-pillar.

- ① The data is vehicle-specific and may differ from that shown. Always observe the specifications on your vehicle identification plate.

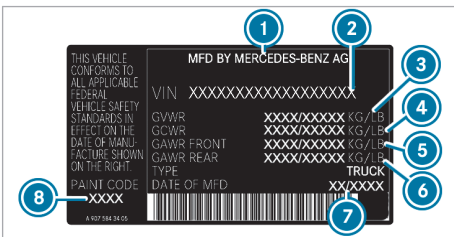

Vehicle identification plate (example: USA, complete vehicles)

- ① Vehicle manufacturer
- ② VIN (vehicle identification number)
- ③ Permissible gross mass

- ④ Permissible gross mass of vehicle combination
- ⑤ Maximum permissible front axle load
- ⑥ Maximum permissible rear axle load
- ⑦ Manufacturing date
- ⑧ Paint code

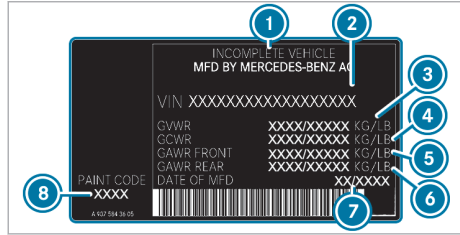

Vehicle identification plate (example: USA, incomplete vehicles)

- ① Vehicle manufacturer
- ② VIN (vehicle identification number)
- ③ Permissible gross mass
- ④ Permissible gross mass of vehicle combination
- ⑤ Maximum permissible front axle load
- ⑥ Maximum permissible rear axle load
- ⑦ Manufacturing date
- ⑧ Paint code

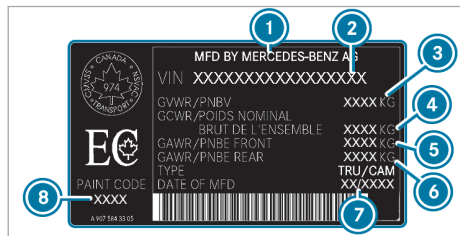

Vehicle identification plate (example: Canada, complete vehicles)

- ① Vehicle manufacturer
- ② VIN (vehicle identification number)
- ③ Permissible gross mass
- ④ Permissible gross mass of vehicle combination
- ⑤ Maximum permissible front axle load
- ⑥ Maximum permissible rear axle load
- ⑦ Manufacturing date
- ⑧ Paint code

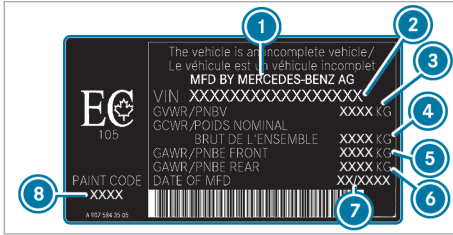

Vehicle identification plate (example: Canada, incomplete vehicles)

- ① Vehicle manufacturer
- ② VIN (vehicle identification number)
- ③ Permissible gross mass
- ④ Permissible gross mass of vehicle combination
- ⑤ Maximum permissible front axle load
- ⑥ Maximum permissible rear axle load
- ⑦ Manufacturing date
- ⑧ Paint code

The permissible gross mass comprises the vehicle weight, all vehicle occupants, the fuel and the load. The maximum gross axle weight rating is the maximum weight that can be carried by one axle (front or rear axle).

Do not exceed the permissible gross mass or the maximum gross axle weight rating of the front or rear axle.

The vehicle identification plate may also include the following data:

- Payload
- Curb weight
- Number of passenger seats

VIN engraved underneath the hood

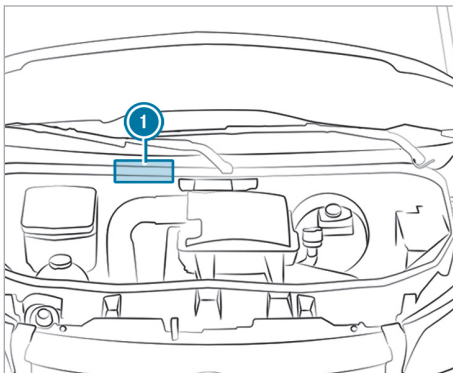

Engraved VIN ① is located underneath the hood.

VIN below the windshield

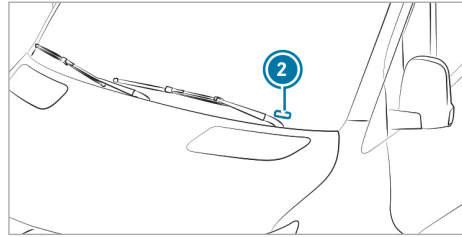

The VIN is also attached as a label on the lower section of the windshield ②.

Emission Control Information label

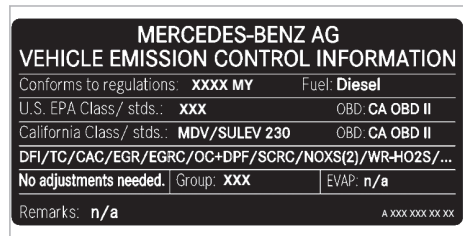

Example: Emission Control Information label

- ① The data is vehicle-specific and may differ from that shown.

Engine number

The engine number is stamped onto the crankcase. Further information can be obtained at a qualified specialist workshop.

Operating fluids and capacities

Notes on operating fluids

⚠ WARNING Risk of injury due to harmful operating fluids

Operating fluids can be toxic.

- ▶ When using, storing and disposing of operating fluids, observe the imprints on the respective original containers.
- ▶ Always keep operating fluids in the sealed original container.
- ▶ Always keep children away from operating fluids.

 **ENVIRONMENTAL NOTE** Pollution of the environment due to irresponsible disposal of operating fluids

Incorrect disposal of operating fluids can cause considerable damage to the environment.

 Dispose of operating fluids in an environmentally responsible manner.

Operating fluids include the following:

- Fuels
- Exhaust gas aftertreatment additives, e.g. DEF®
- Lubricants
- Coolant
- Brake fluid
- Windshield washer fluid
- Climate control system refrigerant

Only use products which have been approved for your vehicle by Mercedes-Benz. Damage caused to the vehicle by using products that have not been approved is not covered by the Mercedes-Benz warranty or goodwill gestures.

You can identify operating fluids approved by Mercedes-Benz by the following labels on the container:



- MB-Freigabe (e.g. MB-Freigabe 229.51)
- MB-Approval (e.g. MB-Approval 229.51)

Further information on approved operating fluids is available from the following sources:

- In the MB Specifications for operating fluids at <https://operatingfluids.mercedes-benz.com> (with details of specification).
- At a qualified specialist workshop





 **WARNING** Risk of fire or explosion from fuel

Fuels are highly flammable.





-  Fire, open flames, smoking and creating sparks must be avoided.
-  Before refueling, switch off the vehicle and, if installed, the stationary heater, and leave them switched off during refueling.

 **WARNING** Risk of injury from fuels

Fuels are poisonous and hazardous to your health.

-  Do not swallow fuel or let it come into contact with skin, eyes or clothing.
-  Do not inhale fuel vapor.
-  Keep children away from fuel.
-  Keep doors and windows closed during the refueling process.

If you or other people come into contact with fuel, observe the following:

-  Immediately rinse fuel off your skin with soap and water.
-  If fuel comes into contact with your eyes, immediately rinse them thoroughly with clean water. Seek medical attention immediately.
-  If you swallow fuel, seek medical attention immediately. Do not induce vomiting.
-  Change immediately out of clothing that has come into contact with fuel.



Fuel

Notes on fuel grades for vehicles with gasoline engine

Observe the notes on operating fluids (→ page 270).

 **NOTE** Do not use diesel to refuel vehicles with a gasoline engine

If you have accidentally refueled with the wrong fuel:

- Do not switch on the vehicle. Otherwise fuel can enter the engine.
Even small amounts of the wrong fuel could result in damage to the fuel system and the engine. The repair costs are high.
-  Consult a qualified specialist workshop.
-  Have the fuel tank and fuel lines drained completely.

Refuel only using low-sulfur regular fuel with an octane number of at least 87 AKI/91 RON.

 E10 fuel contains up to 10% ethanol as an additive. Your vehicle is suitable for use with E10 fuel. You can fuel your vehicle with E10 fuel.

! NOTE Damage caused by the wrong fuel

Even small amounts of the wrong fuel could result in damage to the fuel system, engine and exhaust system.

▶ Only refuel with the recommended fuel.

! NOTE Damage caused by the wrong fuel

Even small amounts of the wrong fuel could result in damage to the fuel system, engine and exhaust system.

Never refuel with the following:

- Diesel
- Gasoline with more than 10% ethanol by volume, e.g. E15, E20, E85, E100
- Gasoline with more than 3% methanol by volume, e.g. M15, M30, M85, M100
- Gasoline with additives containing metal

▶ Do not mix such fuels with the fuel recommended for your vehicle.

i To ensure the longevity and performance of the engine, only regular unleaded gasoline may be used.

Note that you can refuel with higher-quality premium-grade gasoline at any time.

If you are using drums or canisters to refuel the vehicle, you should filter the fuel before filling. This will prevent malfunctions in the fuel system caused by contaminated fuel.

You will usually find information about the fuel quality on the fuel dispenser. If there is no identification on the fuel dispenser, consult a gas station attendant.

i For further information, contact a qualified specialist workshop or visit <http://www.mbusa.com> (USA only).

! Notes on additives in gasoline

Observe the notes on operating fluids (→ page 270).

! NOTE Damage from use of unsuitable additives

Even small amounts of the wrong additive may lead to malfunctions.

▶ Only add cleaning additives recommended for Mercedes-Benz to the fuel.

Mercedes-Benz recommends using brand-name fuels with additives.

In some countries, the available fuel may not contain sufficient amounts of additives. Deposits could build up in the fuel injection system as a result.

In this case, in consultation with a authorized Mercedes-Benz Center, the fuel should be mixed with the cleaning additive recommended by Mercedes-Benz.

You must observe the notes and mixing ratios indicated on the tank.

! Notes on fuel quality for vehicles with diesel engines**General notes**

Observe the notes on operating fluids (→ page 270).

! WARNING Risk of fire from fuel mixture

If you mix diesel fuel with gasoline, the flash point of the fuel mixture is lower than that of pure diesel fuel.

- ▶ Never refuel using gasoline in diesel engines.
- ▶ Never mix gasoline with diesel fuel.

! NOTE Damage due to incorrect fuel

Even small amounts of the wrong fuel could result in damage to the fuel system, the engine and the emission control system.

Never refuel with the following:

- Gasoline
- Marine diesel
- Heating oil
- Pure fatty acid methyl ester (bio-diesel) or vegetable oil
- Paraffin or kerosene

▶ Do not mix such fuels with diesel fuel and do not use any additive.

If you have accidentally refueled with the wrong fuel, observe the following:

- ▶ Do not switch the ignition on.
- ▶ Consult a qualified specialist workshop.

! **NOTE** Malfunctions due to contaminated fuel

Impurities in the fuel can lead to malfunctions in the fuel system.

▶ When refueling the vehicle from drums or canisters, filter the fuel before filling.

! **NOTE** Damage due to incorrect fuel

Incorrect fuel can lead to engine damage.

▶ Refuel only ULSD or diesel fuel with a sulfur content of maximum 15 ppm.

Usually you will find information about the fuel quality on the fuel dispenser. If there is no identification on the fuel dispenser, consult a gas station attendant.

The fuel quality recommended for your vehicle is found on the information label in the fuel filler flap (→ page 132).

Notes on low outside temperatures

! **WARNING** Risk of fire and explosion from igniting fuel

If you heat up parts of the fuel system, fuel may leak and ignite. Depending on the type of damage, fuel might not escape until the engine is running.

- ▶ Never heat fuel system components.
- ▶ Contact a qualified specialist workshop to rectify the malfunction.

Refill only with commercially available ULTRA-LOW sulfur DIESEL (ULSD, maximum sulfur content 15 ppm), which fulfills the ASTM D975 standard.

The flow properties of diesel fuel may be inadequate at low outside temperatures due to paraffin separation.

i Malfunctions resulting from paraffin separation can only be rectified by heating the entire fuel system. Park the vehicle in a heated garage, for example.

To prevent malfunctions, diesel fuel with improved flow characteristics is available in the winter months. You can obtain further information on this at the gas station or from your fuel supplier.

Your vehicle is equipped with a fuel preheating system. This additionally improves the flow characteristics of the diesel fuel by about 14.5°F (8°C). ULTRA-LOW sulfur DIESEL can be used without risk

of malfunction down to an outside temperature of approximately 14.5°F (-10°C).

! **NOTE** Damage due to gasoline or paraffin

Gasoline or paraffin in diesel fuel impairs the lubricity of the diesel fuel. This can result in damage to the diesel injection system, for example.

▶ Do not add any gasoline or paraffin to diesel fuel to improve its flow characteristics.

B20 fuels with bio-diesel content

! **NOTE** Reduced engine output due to fuel with increased bio-contents

The fuel filter may become clogged if fuels with a bio-diesel content of more than 5% (B20 fuels) are used on an ongoing basis. Deposits may also form on the fuel injector. This can reduce engine output. Unburned fuel may get into the oil pan. This can cause the engine oil level to rise.

Observe the following points if you operate your vehicle with fuels with increased bio-contents > 5% on an ongoing basis:

- ▶ If possible, fill up with fuels with bio-contents up to 5% (ULSD).
- ▶ If you regularly refuel with B20 fuels, check the engine oil level regularly.
- ▶ Observe the oil change intervals specified on the instrument cluster and in your service booklet.
- ▶ Use only approved engine oils and filters.
- ▶ If you do not plan to drive the vehicle for several weeks, fill the fuel tank completely with ULSD fuel beforehand.

For more information, consult the gas station staff. The identification of fuels with bio-diesel content (ULSD or B20) must be clear. If the identification is not clear, do not refuel. Do not refuel with any fuels that have not been approved for your vehicle.

Tank capacity and fuel reserve

The total capacity of the fuel tank may vary, depending on the vehicle equipment.

Total fuel tank capacity (gasoline engines)

Gasoline engine	Total capacity
M274	approx. 23 US gal (85 liters)

Fuel tank reserve (gasoline engines)

Gasoline engine	Reserve
M274	approx. 5 US gal (19 liters)

Total fuel tank capacity (diesel engines)

Diesel engine	Total capacity
OM654	approx. 25 US gal (93 liters) or approx. 19 US gal (71 liters)

Fuel tank reserve (diesel engines)

Diesel engine	Reserve
OM654	approx. 3 US gal (12 liters)

DEF (vehicles with a diesel engine only)**Notes on DEF®**

Observe the notes on operating fluids (→ page 270).

DEF® is a water-soluble liquid for the exhaust gas aftertreatment of diesel engines.

! **NOTE** Irritation of skin, eyes and respiratory tract by DEF

DEF may be irritating if inhaled, swallowed or if it comes in contact with eyes or skin. When the tank is opened, ammonia vapors may escape.

- ▶ Do not inhale or swallow DEF.
- ▶ Avoid contact of DEF with skin, eyes or clothing.
- ▶ Keep DEF away from children.
- ▶ Only fill the DEF tank in well-ventilated areas.

If a person has come into contact with DEF, observe the following points:

- If DEF is swallowed, drink plenty of water and seek medical attention immediately.
- If DEF has gotten into the eyes, rinse the eyes with water for 15 minutes, also under the eyelids.
- Immediately rinse off DEF from the skin with water.

! **NOTE** Damage caused by additives in DEF or by diluting DEF

The DEF exhaust gas aftertreatment system could be destroyed by the following:

- Additives in DEF
 - Diluting DEF
- ▶ Only use DEF in accordance with ISO 22241.
- ▶ Do not mix additives.
- ▶ Do not dilute DEF.

! **NOTE** Damage and malfunctions caused by impurities in DEF

Impurities in DEF result in the following:

- Higher emission values
 - Damage to the catalytic converter
 - Engine damage
 - Malfunctions in the DEF exhaust gas aftertreatment system
- ▶ Avoid impurities in DEF.

! **ENVIRONMENTAL NOTE** Soiling with DEF

DEF residue crystallizes after some time and stain the affected surfaces.

- ▶ Immediately rinse surfaces that come in contact with DEF when filling with water or remove DEF with a damp cloth and cold water.

If DEF has already crystallized, clean using a sponge and cold water.

If you open the DEF® tank, small amounts of ammonia vapor may be released. Do not inhale any ammonia vapor that may be released. Fill the DEF® tank only in well-ventilated areas.

Exhaust gas aftertreatment

The vehicle must be operated with DEF[®] if the exhaust gas aftertreatment system is to function correctly.

If you operate the vehicle without DEF[®] or with emissions-relevant malfunctions, the legal DOT approval is invalidated. The vehicle could be prohibited from public road use by an official order.

It may be improper or punishable in some countries to operate a vehicle that uses no DEF[®] or one that does not comply with the specifications of this Operator's Manual.

The engine management system monitors the exhaust gas aftertreatment components for compliance with emission standards and regulations. If you attempt to operate the vehicle without DEF[®], with diluted DEF[®] or with a different reducing agent, this will be detected by the engine management system. Other emissions-relevant malfunctions, e.g. metering malfunctions or sensor errors, are also detected and logged.

The engine management system subsequently prevents the engine from being restarted after issuing a warning message.

Therefore, top up the DEF[®] tank regularly during vehicle operation or, at the latest, after receiving the first warning message via the instrument cluster.

DEF[®] consumption and filling quantity

DEF[®] consumption

Like fuel consumption, DEF[®] consumption is highly dependent upon driving style and operating conditions. DEF[®] consumption is usually within a range of 0 to 10 % of fuel consumption. If necessary, DEF[®] must be topped up in accordance with the instructions when the refill message is displayed in the instrument cluster. This may also be required between scheduled maintenance.

Total capacity of DEF[®] tank

Model	Total capacity
All models	5.8 gal (22 liters)

Engine oil

Notes on engine oil

Observe the notes on operating fluids (→ page 270).



NOTE Engine damage caused by an incorrect oil filter, incorrect oil or additives

- ▶ Do not use engine oils or oil filters other than those which meet the specifications necessary for the prescribed service intervals.
- ▶ Do not alter the engine oil or oil filter in order to achieve longer change intervals than prescribed.
- ▶ Do not use additives.
- ▶ Have the engine oil changed after the prescribed intervals.

Mercedes-Benz recommends having the oil changed at a qualified specialist workshop.

Further information on engine oil and oil filters:

- In the MB Specifications for operating fluids at <https://operatingfluids.mercedes-benz.com> (with details of specification).
- At a qualified specialist workshop

Engine oil quality and filling quantity

i The containers of the various engine oils are marked with the ACEA (Association of European Automotive Manufacturers) and/or API (America Petroleum Institute) classifications. Use only approved engine oils that correspond to the MB Specifications for Operating Fluids and the prescribed ACEA and/or API classifications named below. Engine oils of other grades are not permissible and may result in the loss of the New Vehicle Limited Warranty. The use of other engine oils not approved for diesel engines may damage the diesel particulate filter (DPF).

MB-Freigabe or MB-Approval (gasoline engines)

Gasoline engines	MB-Freigabe or MB-Approval
M274	229.5 ¹⁾
1) recommended for lowest possible fuel consumption (lowest SAE viscosity class in each case; observe possible restrictions of the approved SAE viscosity classes)	

MB-Freigabe or MB-Approval (diesel engines)

Diesel engines	MB-Freigabe or MB-Approval
OM654	229.31, 229.51, 229.52, 229.71 ¹⁾
1) recommended for lowest possible fuel consumption (lowest SAE viscosity class in each case; observe possible restrictions of the approved SAE viscosity classes)	

To achieve the lowest possible fuel consumption, it is recommended to use the engine oil specifications marked in the table for the lowest SAE viscosity class. Observe any possible restrictions of the approved SAE viscosity classes.

- i** If the engine oils listed in the table are not available, adding a maximum of 1.1 US qt (1.0 liter) of the following engine oils is permissible once:

Vehicles with gasoline engine: MB-Freigabe or MB-Approval 229.3 ACEA A3/B4

Vehicles with diesel engine: MB-Freigabe or MB-Approval 228.5, 229.3 or 229.5

Multigrade engine oils of the prescribed SAE viscosity class may be used all year round, taking the outside temperature into account.

Viscosity of the engine oil

! **NOTE** Engine damage due to incorrect SAE classification (viscosity) of the engine oil

If the SAE classification (viscosity) of the engine oil added is not suitable for prolonged low outside temperatures, it may cause engine damage.

The temperature readings of the SAE classification are always based on fresh oil. Engine oil ages when driving as a result of soot and fuel residue. The characteristics of engine oil deteriorate significantly at low outside temperatures.

- ▶ Use an engine oil of the appropriate SAE classification at low outside temperatures.
- ▶ Use oil for all-year-round operation.

The temperature readings of the SAE viscosity class are always based on fresh oil. The temperature characteristics of the engine oil, especially at low outside temperatures, can deteriorate significantly due to aging during operation.

Therefore, Mercedes-Benz recommends that you change the engine oil before the start of the cold season. Use only an approved engine oil in the prescribed SAE viscosity class for this purpose.

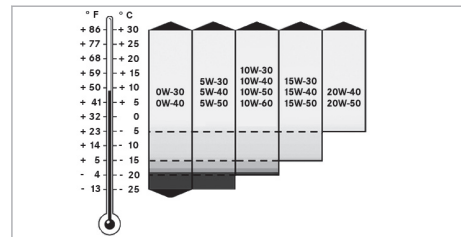

The viscosity indicates the flow characteristics of a fluid. With regard to engine oil, a high viscosity is synonymous with a thick liquid and a low viscosity with a thin liquid. Depending on the outside temperatures, select the engine oil according to the SAE viscosity class. The table shows the SAE viscosity class to be used. The low temperature characteristics of engine oils can deteriorate significantly during operation due to e.g. aging, soot and fuel dilution. A regular oil change with an approved engine oil in the appropriate SAE viscosity class is therefore strongly recommended.

Additives

! **NOTE** Engine damage due to use of additives in the engine oil

The use of additional additives in the engine oil can damage the engine.

- ▶ Do not use any additional additives in the engine oil.

Miscibility of engine oil

Mixing oil reduces the benefits of high-quality engine oils.

We recommend that you use only engine oil of the same grade and SAE viscosity class as the oil used at the last oil change. If, in exceptional cases, engine oil of the type in the engine is not available,

use another approved mineral or synthetic engine oil.

Vehicles with diesel engine: If the grade is not available, you may also refill with engine oils according to MB-Freigabe or MB-Approval 228.5, 229.3 or 229.5. The top-up quantity will then be limited to a maximum of 1.1 US qt (1.0 liter).

Vehicles with gasoline engine: If the grade is not available, you may refill with engine oils according to MB-Freigabe or MB-Approval 229.3 ACEA A3/B4. The top-up quantity will then be limited to a maximum of 1.1 US qt (1.0 liter).

You must then have an oil change carried out at the earliest possible opportunity.

Engine oils are differentiated between according to:

- Engine oil brand
- Grade (MB-Freigabe or MB-Approval)
- SAE viscosity class

Oil change interval

The on-board computer will automatically show the date of the next oil change as an event message on the display.

Mercedes-Benz recommends having the oil changed at a qualified specialist workshop.

Engine oil filling capacity

Engine	Capacity
M274	around 11.1 US qt (10.5 liters)
OM654	around 10.6 US qt (10.0 liters)

Information on oil consumption

Depending on your driving style, the vehicle will consume a maximum of 1.1 US qt (1.0 liter) of engine oil per 620 miles (1,000 km).

In the following cases, oil consumption may also exceed this limit:

- The vehicle is new.
- You use the vehicle mostly under arduous operating conditions.
- You frequently drive at high engine speeds.

Regular maintenance is a prerequisite for favorable consumption figures. You can assess the oil consumption only after a long journey. Check the oil level in the engine regularly, e. g. weekly or every time you refuel.

Notes on brake fluid

Observe the notes on operating fluids (→ page 270).

⚠ WARNING Risk of an accident due to vapor pockets forming in the brake system

The brake fluid constantly absorbs moisture from the air. This lowers the boiling point of the brake fluid. If the boiling point is too low, vapor pockets may form in the brake system when the brakes are applied hard.

This causes the braking effect to be impaired.

▶ Have the brake fluid renewed at the specified intervals.

Have the brake fluid replaced every two years at a qualified specialist workshop.

! NOTE Damage to paint, plastic or rubber by brake fluid

There is a risk of damage to property if brake fluid comes into contact with paint, plastic or rubber.

▶ If paint, plastic or rubber comes into contact with brake fluid, rinse with water immediately.

Observe the notes on paintwork/matte paintwork care (→ page 222).

Only use brake fluid approved by Mercedes-Benz in accordance with MB-Freigabe or MB-Approval 331.0.

Information on brake fluid is available at the following locations:

- In the MB Specifications for operating fluids 331.0 at <https://operatingfluids.mercedes-benz.com>
- At a qualified specialist workshop

Coolant

Notes on coolant

Observe the notes on operating fluids (→ page 270).

⚠ WARNING Risk of Fire and injury due to antifreeze

If antifreeze comes into contact with hot components in the engine compartment, it may ignite.

- ▶ Allow the vehicle to cool down before refilling with antifreeze.
- ▶ Make sure that antifreeze does not spill out over the filler neck.
- ▶ Before starting the vehicle, thoroughly clean the components contaminated with antifreeze.

! **NOTE** Damage caused by incorrect coolant

- ▶ Only add coolant that has been premixed with the required antifreeze protection.

Information on coolant is available at the following locations:

- In the MB Specifications for operating fluids 320.1 at <https://operatingfluids.mercedes-benz.com>
- At a qualified specialist workshop

! **NOTE** Overheating at high outside temperatures

If an inappropriate coolant is used, the engine cooling system is not sufficiently protected against overheating and corrosion at high outside temperatures.

- ▶ Always use coolant approved for Mercedes-Benz.
- ▶ Observe the instructions in the MB Specifications for operating fluids 320.1.

! **NOTE** Paintwork damage due to coolant

- ▶ Do not spill coolant on painted surfaces.

Have the coolant regularly replaced at a qualified specialist workshop.

Note the proportion of anti-corrosion agent/antifreeze in the engine cooling system within the following temperature ranges:

- A minimum of 50 % (antifreeze protection down to about -35°F (-37°C))
- A maximum of 55 % (antifreeze protection down to -49°F (-45°C))

■ Coolant capacity

The capacity may vary depending on the engine type and equipment.

Coolant

Engine	Capacity
M274	around 1.3 gal (4.8 liters)
OM654	around 1.3 gal (5.0 liters) or around 1.8 gal (7.0 liters)
OM654 with auxiliary heating	around 2.2 gal (8.2 liters)

Windshield washer fluid

■ Notes on windshield washer fluid

Observe the notes on operating fluids (→ page 270).

! **WARNING** - Risk of fire and injury from windshield washer concentrate

Windshield washer concentrate is highly flammable. It could ignite if it comes into contact with hot engine component parts or the exhaust system.

- ▶ Make sure that no windshield washer concentrate spills out next to the filler opening.

! **NOTE** Damage to the exterior lighting due to unsuitable windshield washer fluid

Unsuitable windshield washer fluid may damage the plastic surface of the exterior lighting.

- ▶ Only use windshield washer fluid which is also suitable for use on plastic surfaces, e.g. MB SummerFit or MB WinterFit.

! **NOTE** Blocked spray nozzles caused by mixing windshield washer fluids

- ▶ Do not mix MB SummerFit and MB WinterFit with other windshield washer fluids.

Do not use distilled or de-ionized water. Otherwise, the fill level sensor may give a false reading.

■ Information on the windshield washer fluid

Recommended windshield washer fluid:

- Above freezing point: e.g. MB SummerFit
- Below freezing point: e.g. MB WinterFit

Mixing ratio

For the correct mixing ratio, refer to the information on the anti-freeze container.

Mix the washer fluid with windshield washer fluid all year round.

Filling quantities

Windshield washer system

Washer fluid	5.8 qt (5.5 l)
--------------	----------------

Refrigerant

Notes on refrigerant

Observe the notes on operating fluids (→ page 270).

- ① Your vehicle's climate control system is filled with the refrigerant R134a. The refrigerant R134a contains fluorinated greenhouse gas.

NOTE Damage due to incorrect refrigerant or refrigerant compressor oil

If the incorrect refrigerant or refrigerant compressor oil (PAG oil) is used, this can damage the climate control system.

- ▶ Use only R-134a refrigerant and the PAG oil approved for your vehicle by Mercedes-Benz.
- ▶ Do not mix the approved PAG oil with another PAG oil.

Maintenance work, such as refilling refrigerant or replacing components, may be carried out only by a qualified specialist workshop. All applicable regulations, as well as SAE standard J639, must be adhered to.

Have all work on the climate control system carried out at a qualified specialist workshop.

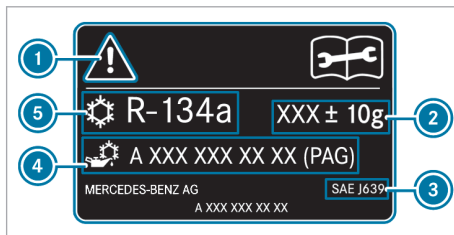

Example: refrigerant information label

- ① Symbols for hazard and service information
- ② Refrigerant capacity

- ③ Applicable standards
- ④ PAG oil part number
- ⑤ Refrigerant type

Symbols ① advise you of the following:

- Potential dangers
- Having maintenance work carried out at a qualified specialist workshop

Vehicle data

Vehicle dimensions

The following section contains important technical data for your vehicle. Your vehicle documents contain further vehicle-specific and equipment-dependent technical data such as vehicle dimensions and weights.

Trailer hitch

Notes on the trailer hitch

WARNING Risk of accident due to impermissible attachment of a trailer tow hitch

If you install a trailer tow hitch or other components, the longitudinal frame member is weakened and can break. The trailer may become detached from the vehicle.

There is a risk of an accident.

Only retrofit a trailer tow hitch if permissible.

Observe the notes on trailer operation (→ page 170).

Retrofitting a trailer hitch is only permissible if a towing capacity is specified in your vehicle documents.

You can obtain further information on the trailer hitch at a qualified specialist workshop.

Mercedes-Benz recommends that you have a trailer hitch retrofitted at an authorized Mercedes-Benz Center.

Only use a trailer hitch which has been tested and specially approved by Mercedes-Benz for your vehicle.

Use only a ball neck that has been approved for your vehicle and for your Sprinter trailer hitch. Notes on the permissible dimensions of the ball neck can also be found on the identification plate of the trailer hitch.

The maximum permissible towing capacity for unbraked trailers is 1,653 lbs (750 kg).

Trailer loads

The permissible weights and loads can also be obtained from the following sources of information:

- Vehicle documents
- The identification plates of the trailer coupling, trailer and vehicle

The values approved by the manufacturer can be found in the following table. If the figures differ, the lowest figure will apply. Use a calibrated weighing device to check compliance with weight restrictions before you start your journey.

Maximum permissible weights and loads

Vehicle type, gross vehicle weight and curb weight

Vehicle model	Gross vehicle weight rating (GVWR)	Permissible curb weight ⁷⁾
1500	8550 lbs (3.878 t)	6950 lbs (3.152 t) (gasoline only)
2500	8550 lbs (3.878 t)	7400 lbs (3.357 t) (diesel only)
	9050 lbs (4.105 t)	6450 lbs (2.926 t) (gasoline only)
		7400 lbs (3.357 t) (diesel only)
	9480 lbs (4.300 t)	7400 lbs (3.357 t) (diesel only)
3500	9900 lbs (4.490 t) (Canada only)	7400 lbs (3.357 t)
	9989 lbs (4.531 t) (USA only)	
3500 XD	11,030 lbs (5.003 t)	10,470 lbs (4.749 t)
4500	12,125 lbs (5.500 t)	9375 lbs (4.252 t)

⁷⁾ Maximum permissible curb weight of a vehicle in ready-to-drive condition without driver or vehicle occupants, including all fluids and their reservoirs when filled up to 100%.

Front axle load, rear axle load, gross weight of vehicle combination (standard, optional)

Vehicle types 1500 and 2500 with a maximum gross vehicle weight rating of 8550 lbs (3.878 t), 9050 lbs (4.105 t) and 9480 lbs (4.300 t)

Permissible front axle load GAWR (FA)	Permissible rear axle load GAWR (RA)
4100 lbs (1.860 t) ⁵⁾	5360 lbs (2.431 t)
4410 lbs (2.000 t) ¹⁾	

Vehicle type 3500 with a maximum gross vehicle weight rating of 9900 lbs (4.490 t) (Canada only) and 9989 lbs (4.531 t) (USA only)

Permissible front axle load GAWR (FA)	Permissible rear axle load GAWR (RA)
4080 lbs (1.851 t) ⁵⁾	7060 lbs (3.202 t)
4410 lbs (2.000 t) ¹⁾	

Vehicle type 3500 XD with a maximum gross vehicle weight rating of 11,030 lbs (5.003 t)

Permissible front axle load GAWR (FA)	Permissible rear axle load GAWR (RA)
4080 lbs (1.851 t) ⁵⁾	7720 lbs (3.502 t)
4410 lbs (2.000 t) ¹⁾	

Vehicle type 4500 with a maximum gross vehicle weight rating of 12,125 lbs (5.500 t)

Permissible front axle load GAWR (FA)	Permissible rear axle load GAWR (RA)
4630 lbs (2.100 t)	7935 lbs (3.599 t)

¹⁾ Front axle with increased load capacity.

⁵⁾ Not in combination with all-wheel drive (AWD) and not in combination with vehicle model designation 907.745 (combination vehicles with a vehicle length of 290 inches (7367 mm))

Gross vehicle combination weight, trailer load, tongue weight

Vehicle types 1500 and 2500 with a maximum gross vehicle weight rating of 8550 lbs (3.878 t)

Permissible gross weight for vehicle/trailer combination (GCWR) ^{6), 9)}	Gross trailer weight (GTW), braked ⁶⁾	Tongue weight rating (TWR)
13,550 lbs (6.146 t)	5000 lbs (2.268 t) ²⁾	500 lbs (0.227 t) ²⁾

Vehicle type 2500 with a maximum gross vehicle weight rating of 9050 lbs (4.105 t)

Permissible gross weight for vehicle/trailer combination (GCWR) ^{6), 9)}	Gross trailer weight (GTW), braked ⁶⁾	Tongue weight rating (TWR)
13,930 lbs (6.319 t)	5000 lbs (2.268 t) ²⁾	500 lbs (0.227 t) ²⁾

Vehicle type 2500 with a maximum gross vehicle weight rating of 9480 lbs (4.300 t)

Permissible gross weight for vehicle/trailer combination (GCWR) ^{6), 9)}	Gross trailer weight (GTW), braked ⁶⁾	Tongue weight rating (TWR)
9480 lbs (4.300 t)	–	–

Vehicle type 3500 with a maximum gross vehicle weight rating of 9900 lbs (4.490 t) (Canada only)

Permissible gross weight for vehicle/trailer combination (GCWR) ^{6), 9)}	Gross trailer weight (GTW), braked ⁶⁾	Tongue weight rating (TWR)
14,900 lbs (6.759 t) ²⁾ , only for vehicle model designation 907.657 ⁸⁾	5000 lbs (2.268 t) ²⁾ , only for vehicle model designation 907.657 ⁸⁾	500 lbs (0.227 t) ²⁾ , only for vehicle model designation 907.657 ⁸⁾
15,250 lbs (6.917 t) ³⁾ , not for vehicle model designation 907.657 ⁸⁾	7500 lbs (3.402 t) ³⁾ , not for vehicle model designation 907.657 ⁸⁾	750 lbs (0.340 t) ³⁾ , not for vehicle model designation 907.657 ⁸⁾

Vehicle type 3500 with a maximum gross vehicle weight rating of 9990 lbs (4.531 t) (USA only)

Permissible gross weight for vehicle/trailer combination (GCWR) ^{6), 9)}	Gross trailer weight (GTW), braked ⁶⁾	Tongue weight rating (TWR)
14,990 lbs (6.799 t) ²⁾ , only for vehicle model designation 907.657 ⁸⁾	5004 lbs (2.270 t) ²⁾ , only for vehicle model designation 907.657 ⁸⁾	500 lbs (0.227 t) ²⁾ , only for vehicle model designation 907.657 ⁸⁾
15,250 lbs (6.917 t) ³⁾ , not for vehicle model designation 907.657 ⁸⁾	7500 lbs (3.402 t) ³⁾ , not for vehicle model designation 907.657 ⁸⁾	750 lbs (0.340 t) ³⁾ , not for vehicle model designation 907.657 ⁸⁾

Vehicle type 3500 XD with a maximum gross vehicle weight rating of 11,030 lbs (5.003 t)

Permissible gross weight for vehicle/trailer combination (GCWR) ^{6), 9)}	Gross trailer weight (GTW), braked ⁶⁾	Tongue weight rating (TWR)
15,250 lbs (6.917 t) ⁴⁾	5004 lbs (2.270 t) ²⁾ , only for vehicle model designation 907.657 ⁸⁾	500 lbs (0.227 t) ²⁾ , only for vehicle model designation 907.657 ⁸⁾
	optional: 7500 lbs (3.402 t) ³⁾ , not for vehicle model designation 907.657 ⁸⁾	optional: 750 lbs (0.340 t) ³⁾ , not for vehicle model designation 907.657 ⁸⁾

Vehicle type 4500 with a maximum gross vehicle weight rating of 12,125 lbs (5.500 t)

Permissible gross weight for vehicle/trailer combination (GCWR) ^{6), 9)}	Gross trailer weight (GTW), braked ⁶⁾	Tongue weight rating (TWR)
15,250 lbs (6.917 t) ⁴⁾	5004 lbs (2.270 t) ²⁾ , only for vehicle model designation 907.657 ⁸⁾	500 lbs (0.227 t) ²⁾ , only for vehicle model designation 907.657 ⁸⁾
	optional: 7500 lbs (3.400 t) ³⁾ , not for vehicle model designation 907.657 ⁸⁾	optional: 750 lbs (0.340 t) ³⁾ , not for vehicle model designation 907.657 ⁸⁾

²⁾ Only NAFTA trailer cross member, trailer load 5004 lbs (2.270 t).

³⁾ Only NAFTA trailer cross member, towing capacity 7500 lbs (3.400 t).

⁴⁾ Only NAFTA trailer cross member, trailer load 5004 lbs (2.270 t) or 7500 lbs (3.400 t).

⁶⁾ In trailer operation, do not exceed any individual maximum permissible gross weight of those specified in the table.

⁸⁾ The vehicle length for vehicles with the vehicle model designation 907.657 (Cargo Van) is 290 in (7367 mm).

⁹⁾ Any vehicle not equipped with a trailer coupling as standard cannot tow a trailer. In this case, the maximum gross vehicle weight rating corresponds to the maximum permissible gross weight for the vehicle combination.

i If the trailer coupling is retrofitted, adapt the type plates accordingly with the altered maximum permissible weights. Please consult an authorized Mercedes-Benz Center if you have any further questions.

MERCEDES-BENZ AG

<p>IMPORTANT INFORMATION FOR BODY BUILDERS</p> <p>This vehicle and engine conform to all applicable US EPA, CARB and Canadian regulations at the time of manufacture for vehicles <UO> 10000 lbs GVWR and has a maximum unloaded vehicle weight (UVW) of <UVW> lbs.</p>	<p>INFORMATIONS IMPORTANTES POUR LES CARROSSIERS</p> <p>Le véhicule et le moteur sont conformes aux directives EPA CARB (É.-U.) et du Canada applicables à la date de production du véhicule ayant un PNBV <UO> à 10000 lb et un poids à vide max. de <UVW> lb.</p>
--	--

A 907 584 26 05

The bodybuilder label is found on the front-end module above the radiator and contains the vehicle's maximum permissible curb weight.

Cargo tie-down points and carrier systems

Loading capacity of the cargo tie-down point and tie-down eyes

! **NOTE** Risk of accident if the maximum loading capacity of the cargo tie-down points is exceeded

During maximum full-stop braking, for example, forces act that can multiply the weight force of the load.

- ▶ If various cargo tie-down points are combined to secure a load, always take the maximum loading capacity of the weakest cargo tie-down point into account.
- ▶ Always use several cargo tie-down points to distribute and spread the load. Distribute the load on the cargo tie-down points evenly.

Rated tensile force is the maximum permissible tensile force.

Further information on the cargo tie-down point and tie-down eyes can be obtained in the "Transporting" section (→ page 210).

Tie-down eyes

Rated tensile force of tie-down eyes

Tie-down eyes	Rated tensile force
Passenger Van	786.5 lbf (350 daN)
Cargo Van	1 798.5 lbf (800 daN)

Loading rails

Rated tensile force of cargo tie-down point in the cargo compartment

Cargo tie-down point	Rated tensile force
Loading rails on cargo floor	1 124.0 lbf (500 daN)
Lower loading rail on side wall	449.6 lbf (200 daN)
Upper loading rail on side wall	281.0 lbf (125 daN)

The values specified apply only to loads resting on the cargo floor under the following conditions:

Conditions:

- the load is secured to two cargo tie-down point on the rail
- the distance to the nearest load-securing point on the same rail is approximately 3 ft (1 m).

Information about roof luggage racks

⚠ WARNING Risk of injury if maximum roof load is exceeded

The vehicle center of gravity and the usual driving characteristics as well as the steering and braking characteristics will change.

If you exceed the maximum roof load, the handling as well as steering and braking characteristics are severely affected.

- ▶ Always comply with the maximum roof load and adjust your driving style.

⚠ WARNING Danger of accident due to uneven loading

The driving characteristics, as well as steering and braking characteristics, may be greatly impaired.

- ▶ Load the vehicle evenly.
- ▶ Secure the load against sliding.

The driving, braking and steering characteristics of the vehicle will change with the type of load, the weight and the center of gravity of the load.

! **NOTE** Risk of accident if the maximum permissible roof load is exceeded

If the weight of the roof luggage, including the roof luggage rack, exceeds the maximum permissible roof load, there will be a risk of an accident.

- ▶ Ensure that the weight of the roof luggage and roof luggage rack does not exceed the maximum permissible roof load.
- ▶ The roof luggage rack supports must be arranged at an even distance from each other.

Further information about safety measures can be found in the "Transport" section (→ page 210).

Max. roof load/pairs of roof luggage rack supports

Vehicles with	Maximum roof load	Minimum number of pairs of supports
Roof	661 lbs (300 kg)	6
High roof	331 lbs (150 kg)	3

This information applies if the load is distributed evenly across the entire roof area.

If the roof luggage rack is shorter, reduce the load proportionately. The maximum load per pair of roof luggage rack supports is 110 lbs (50 kg).

The loading guidelines and other information about load distribution and load securing can be found in the "Transport" section (→ page 210).

Display messages

Introduction

Function of display messages

Display messages appear on the instrument cluster.

The display messages with graphic displays can be displayed in simplified format in the Operator's Manual and may deviate from the display on the instrument cluster. The instrument cluster shows high-priority display messages in red. In addition, a warning tone sounds for specific display messages.

Act in accordance with the display messages and comply with the additional instructions in this Operator's Manual.



In addition, symbols are shown for some display messages:



Further information



Hide display messages

You can use the left-hand Touch Control to select between the symbols by swiping to the left or right. Pressing  displays further information on the instrument cluster. Pressing  hides the display message.

You can hide low-priority display messages by pressing the  button or with the left-hand Touch Control. The display messages are saved in the message memory.

Rectify the cause of a display message as quickly as possible.



You cannot hide high-priority display messages. The instrument cluster will show these display messages until their causes have been rectified.

Calling up saved display messages







On-board computer:



 Service  1 Message

If there are no display messages, **No Messages** will appear on the instrument cluster display.



-  Browse through the display messages by swiping upwards or downwards on the left-hand Touch Control.
-  **To exit the message memory:** press the  button.



Safety systems

Display messages	Possible causes/consequences and ► Solutions
 <p data-bbox="207 390 431 467">Left Side Curtain Airbag Malfunction Service Required (example)</p>	<p data-bbox="484 301 1054 324">* The respective window air bag is malfunctioning (→ page 40).</p> <div data-bbox="505 342 1129 401" style="background-color: #f0f0f0; padding: 5px;"> <p data-bbox="514 347 1106 401">▲ WARNING Risk of injury or fatal injury due to a malfunction in the window curtain airbag</p> </div> <div data-bbox="514 413 1129 526" style="padding: 5px;"> <p data-bbox="518 413 1084 462">The window curtain airbag might be triggered unintentionally or might not be triggered at all in the event of an accident.</p> <p data-bbox="518 467 1093 521">► Have the window curtain airbag checked and repaired immediately at a qualified specialist workshop.</p> </div> <p data-bbox="501 544 1001 569">► Consult a qualified specialist workshop immediately.</p>
 <p data-bbox="207 677 431 754">Front Left Malfunction Service Required (example)</p>	<p data-bbox="484 582 1102 605">* The corresponding restraint system is malfunctioning (→ page 35).</p> <div data-bbox="505 623 1129 682" style="background-color: #f0f0f0; padding: 5px;"> <p data-bbox="514 628 1093 682">▲ WARNING Risk of injury due to malfunctions in the restraint system</p> </div> <div data-bbox="514 695 1129 808" style="padding: 5px;"> <p data-bbox="518 695 1106 743">Components in the restraint system may be activated unintentionally or not deploy as planned in an accident.</p> <p data-bbox="518 749 1093 802">► Have the restraint system checked and repaired immediately at a qualified specialist workshop.</p> </div> <p data-bbox="501 831 913 856">Recognition of a restraint system malfunction:</p> <ul data-bbox="510 861 1119 974" style="list-style-type: none"> <li data-bbox="510 861 1102 915">• The  restraint system warning lamp does not light up when the vehicle is switched on. <li data-bbox="510 921 1119 974">• The  restraint system warning lamp lights up continuously or repeatedly during a journey. <p data-bbox="501 992 1001 1017">► Consult a qualified specialist workshop immediately.</p>
 <p data-bbox="207 1125 431 1171">SRS Malfunction Service Required</p>	<p data-bbox="484 1030 971 1053">* The restraint system is malfunctioning (→ page 35).</p> <div data-bbox="505 1071 1129 1130" style="background-color: #f0f0f0; padding: 5px;"> <p data-bbox="514 1076 1093 1130">▲ WARNING Risk of injury due to malfunctions in the restraint system</p> </div> <div data-bbox="514 1143 1129 1256" style="padding: 5px;"> <p data-bbox="518 1143 1106 1191">Components in the restraint system may be activated unintentionally or not deploy as planned in an accident.</p> <p data-bbox="518 1197 1093 1250">► Have the restraint system checked and repaired immediately at a qualified specialist workshop.</p> </div> <p data-bbox="501 1279 913 1304">Recognition of a restraint system malfunction:</p> <ul data-bbox="510 1309 1119 1422" style="list-style-type: none"> <li data-bbox="510 1309 1102 1363">• The restraint system warning lamp  does not light up when the vehicle is switched on. <li data-bbox="510 1369 1119 1422">• The restraint system warning lamp  lights up continuously or repeatedly during a journey. <p data-bbox="501 1440 1001 1465">► Consult a qualified specialist workshop immediately.</p>

Display messages	Possible causes/consequences and ► Solutions
 <p>Parking Brake Inoperative</p>	<p>* A malfunction has occurred in the system; the parking brake is inoperative.</p> <div style="border: 1px solid gray; padding: 5px; margin-bottom: 10px;"> <p>▲ WARNING Risk of an accident due to a brake system malfunction</p> <p>If the brake system is malfunctioning, braking characteristics may be impaired.</p> <ul style="list-style-type: none"> ▶ Drive on carefully. ▶ Have the brake system checked immediately at a qualified specialist workshop. </div> <ul style="list-style-type: none"> ▶ Park the vehicle on a level surface only and secure it against rolling away. ▶ Vehicles with automatic transmission: shift the transmission to position [P]. ▶ Have the brake system checked at a qualified specialist workshop immediately.
 <p>Incline Too Steep See Operator's Manual</p>	<p>* The on-board electrical system voltage is low or a malfunction has occurred in the system; the holding force may not be sufficient for the incline.</p> <div style="border: 1px solid gray; padding: 5px; margin-bottom: 10px;"> <p>▲ WARNING Risk of accident if the electrical parking brake has insufficient holding force</p> <p>If the electrical parking brake does not have sufficient holding force on a steep incline, the vehicle may roll away.</p> <ul style="list-style-type: none"> ▶ Park the vehicle on a level surface only and secure it against rolling away. ▶ Shift the automatic transmission to position [P]. </div> <p>Observe the notes on parking the vehicle (→ page 139).</p>
 <p>Parking Brake See Operator's Manual</p>	<p>* The on-board electrical system voltage is low or a malfunction has occurred in the system; the closing force may not be sufficient for the incline.</p> <div style="border: 1px solid gray; padding: 5px; margin-bottom: 10px;"> <p>▲ WARNING Risk of an accident due to a brake system malfunction</p> <p>If the brake system is malfunctioning, braking characteristics may be impaired.</p> <ul style="list-style-type: none"> ▶ Drive on carefully. ▶ Have the brake system checked immediately at a qualified specialist workshop. </div> <ul style="list-style-type: none"> ▶ Park the vehicle on a level surface only and secure it against rolling away. ▶ Vehicles with automatic transmission: shift the transmission to position [P]. ▶ Have the brake system checked at a qualified specialist workshop immediately.



Display messages	Possible causes/consequences and ► Solutions
<p>Check Brake Pads See Operator's Manual</p>	<p>* The brakepads have reached their wear limit.</p> <div style="border: 1px solid gray; padding: 5px; margin: 5px 0;"> <p>⚠ WARNING Risk of accident due to restricted braking power</p> <p>When the brake pads have reached their wear limit, the braking power may be restricted.</p> <ul style="list-style-type: none"> ► Drive on carefully. ► Have the brake system checked immediately at a qualified specialist workshop. </div> <p>► Consult a qualified specialist workshop.</p>
<div style="text-align: center; margin-bottom: 5px;">  </div> <p>Check Brake Fluid Level</p>	<p>* There is insufficient brake fluid in the brake fluid reservoir.</p> <div style="border: 1px solid gray; padding: 5px; margin: 5px 0;"> <p>⚠ WARNING Risk of an accident due to low brake fluid level</p> <p>If the brake fluid level is too low, the braking effect and the braking characteristics may be impaired.</p> <ul style="list-style-type: none"> ► Pull over and stop the vehicle safely as soon as possible, paying attention to road and traffic conditions. Do not continue driving under any circumstances. ► Consult a qualified specialist workshop. ► Do not add brake fluid. </div> <p>► Stop the vehicle immediately in accordance with the traffic conditions. Do not continue driving!</p> <p>► Contact a qualified specialist workshop.</p> <p>► Do not add brake fluid.</p>
<p>Active Brake Assist Functions Limited See Operator's Manual</p>	<p>* Active Brake Assist is malfunctioning.</p> <p>► Consult a qualified specialist workshop.</p>
<p>Active Brake Assist Functions Currently Limited See Operator's Manual</p>	<p>* Active Brake Assist is temporarily unavailable.</p> <p>The ambient conditions are outside the system limits (→ page 147).</p> <p>► Drive on.</p> <p>When the ambient conditions are within the system limits, the system will be available again.</p> <p>► If the display message does not disappear, stop the vehicle in accordance with the traffic conditions and restart it.</p>
<p>Radar Sensors Dirty See Operator's Manual</p>	<p>* The radar sensor system is malfunctioning. Possible causes:</p> <ul style="list-style-type: none"> • Dirt on the sensors • Heavy precipitation • Extended country driving without other traffic, e.g. in the desert <p>Driving systems and driving safety systems may be malfunctioning or temporarily unavailable.</p> <p>When the causes have been eliminated, the driving systems and driving safety systems will be available again.</p> <p>If the display message does not disappear, proceed as follows:</p>



Display messages	Possible causes/consequences and ► Solutions
	<ul style="list-style-type: none"> ► Stop in accordance with the traffic conditions. ► Clean all sensors (→ page 222). ► Restart the vehicle.
<p>SOS NOT READY</p>	<p>* The emergency call system is not available. Possible causes for this include:</p> <ul style="list-style-type: none"> • The vehicle is switched off. • The emergency call system is malfunctioning. <p>► Switch on the vehicle. If an emergency call is unavailable, a message to this effect will appear on the instrument cluster.</p> <p>► Consult a qualified specialist workshop.</p> <p>❗ You can find more information on the regional availability of the emergency call system at: http://www.mercedes-benz.com/connect_ecall</p>
<div style="border: 1px solid black; padding: 5px; margin-bottom: 5px; text-align: center;"> EBD </div> <div style="border: 1px solid black; padding: 5px; margin-bottom: 5px; text-align: center;">  </div> <div style="border: 1px solid black; padding: 5px; text-align: center;">  </div> <p>Inoperative See Operator's Manual</p>	<p>* EBD, ABS and ESP® are malfunctioning. Other driving systems and driving safety systems may also be malfunctioning.</p> <div style="border: 1px solid gray; padding: 5px; margin-top: 10px;"> <p>⚠ WARNING Risk of skidding if EBD, ABS and ESP® are malfunctioning</p> <p>The wheels may block during braking and ESP® does not perform any vehicle stabilization. The steerability and braking characteristics are heavily impaired and the braking distance may increase. In addition, other driving safety systems are switched off.</p> <ul style="list-style-type: none"> ► Drive on carefully. ► Have the brake system checked immediately at a qualified specialist workshop. </div> <p>► Drive on carefully.</p> <p>► Consult a qualified specialist workshop immediately.</p>
<div style="border: 1px solid black; padding: 5px; text-align: center;">  </div> <p>Inoperative See Operator's Manual</p>	<p>* ESP® is malfunctioning. Other driving systems and driving safety systems may also be malfunctioning. The brake system continues working with the normal effect. Braking distance may increase in an emergency braking situation.</p> <div style="border: 1px solid gray; padding: 5px; margin-top: 10px;"> <p>⚠ WARNING Risk of skidding if ESP® is malfunctioning</p> <p>If ESP® is malfunctioning, ESP® cannot carry out vehicle stabilization. In addition, other driving safety systems are switched off.</p> <ul style="list-style-type: none"> ► Drive on carefully. ► Have ESP® checked at a qualified specialist workshop. </div> <p>► Drive on carefully.</p>

Display messages	Possible causes/consequences and ► Solutions
 <p>Currently Unavailable See Operator's Manual</p>	<ul style="list-style-type: none"> ► Consult a qualified specialist workshop immediately. <p>* ESP® is temporarily unavailable. Other driving systems and driving safety systems may also be malfunctioning.</p> <div style="border: 1px solid gray; padding: 5px; margin: 5px 0;"> <p>▲ WARNING Risk of skidding if ESP® is malfunctioning</p> <p>If ESP® is malfunctioning, ESP® cannot carry out vehicle stabilization. In addition, other driving safety systems are switched off.</p> <ul style="list-style-type: none"> ► Drive on carefully. ► Have ESP® checked at a qualified specialist workshop. </div> <ul style="list-style-type: none"> ► Carefully drive some gentle curves at a speed greater than 19 mph (30 km/h) on a suitable stretch of road. ► If the display message does not disappear, visit a qualified specialist workshop immediately. Drive carefully when doing so.
 <p>Currently Unavailable See Operator's Manual</p>	<p>* ABS and ESP® are temporarily unavailable. Other driving systems and driving safety systems may also be temporarily unavailable.</p> <div style="border: 1px solid gray; padding: 5px; margin: 5px 0;"> <p>▲ WARNING Risk of skidding if ABS and ESP® are malfunctioning</p> <p>The wheels may block during braking and ESP® does not perform any vehicle stabilization.</p> <p>The steerability and braking characteristics are heavily impaired and the braking distance may increase. In addition, other driving safety systems are switched off.</p> <ul style="list-style-type: none"> ► Drive on carefully. ► Have ABS and ESP® checked immediately at a qualified specialist workshop. </div> <ul style="list-style-type: none"> ► Carefully drive some gentle curves at a speed greater than 19 mph (30 km/h) on a suitable stretch of road. ► If the display message does not disappear, visit a qualified specialist workshop immediately. Drive carefully when doing so.
 <p>Inoperative See Operator's Manual</p>	<p>* ABS and ESP® are malfunctioning. Other driving systems and driving safety systems may also be malfunctioning.</p> <p>The brake system continues working with the normal effect. Braking distance may increase in an emergency braking situation.</p> <div style="border: 1px solid gray; padding: 5px; margin: 5px 0;"> <p>▲ WARNING Risk of skidding if ABS and ESP® are malfunctioning</p> <p>The wheels may block during braking and ESP® does not perform any vehicle stabilization.</p> </div>



Display messages	Possible causes/consequences and ► Solutions
	<p>The steerability and braking characteristics are heavily impaired and the braking distance may increase. In addition, other driving safety systems are switched off.</p> <ul style="list-style-type: none"> ► Drive on carefully. ► Have ABS and ESP® checked immediately at a qualified specialist workshop. <ul style="list-style-type: none"> ► Drive on carefully. ► Consult a qualified specialist workshop immediately.

Driving systems





Display messages	Possible causes/consequences and ► Solutions
<p>CRUISE CONTROL Inoperative</p>	<ul style="list-style-type: none"> * Cruise control is malfunctioning. <ul style="list-style-type: none"> ► Consult a qualified specialist workshop.
 <p>Off</p>	<ul style="list-style-type: none"> * Cruise control has been deactivated. If a warning tone also sounds, this means cruise control has deactivated itself automatically (→ page 149).
 <p>--- mph</p>	<ul style="list-style-type: none"> * Cruise control cannot be activated as not all activation conditions have been met. <ul style="list-style-type: none"> ► Observe the activation conditions for cruise control (→ page 150).
<p>Active Distance Assist Inoperative</p>	<ul style="list-style-type: none"> * Active Distance Assist DISTRONIC is malfunctioning. Other driving systems and driving safety systems may also be malfunctioning. <ul style="list-style-type: none"> ► Consult a qualified specialist workshop.
<p>Active Distance Assist Currently Unavailable See Operator's Manual</p>	<ul style="list-style-type: none"> * Active Distance Assist DISTRONIC is temporarily unavailable. The ambient conditions are outside the system limits (→ page 152). <ul style="list-style-type: none"> ► Stop in accordance with the traffic conditions ► Restart the vehicle When the ambient conditions are within the system limits, the system will be available again.
<p>Active Distance Assist Now Available</p>	<ul style="list-style-type: none"> * Active Distance Assist DISTRONIC is operational again and can be activated (→ page 153).





Display messages	Possible causes/consequences and ► Solutions
 <p data-bbox="207 516 431 564">Currently Unavailable Camera View Restricted</p>	<p data-bbox="484 259 921 283">* The camera view is restricted. Possible causes:</p> <ul data-bbox="510 290 1000 349" style="list-style-type: none"> • Dirt on the windshield in the camera's field of vision • Heavy precipitation or fog <p data-bbox="502 367 1115 415">Driving systems and driving safety systems may be malfunctioning or temporarily unavailable.</p> <p data-bbox="502 426 1115 474">When the causes have been eliminated, the driving systems and driving safety systems will be available again.</p> <p data-bbox="502 483 881 507">If the display message does not disappear:</p> <ul data-bbox="502 516 1000 609" style="list-style-type: none"> ► Stop in accordance with the traffic conditions. ► Clean the windshield. ► If necessary, consult a qualified specialist workshop.
 <p data-bbox="207 824 407 872">Currently Unavailable Radar Sensors Dirty</p>	<p data-bbox="484 625 1037 648">* The radar sensor system is malfunctioning. Possible causes:</p> <ul data-bbox="510 655 1102 749" style="list-style-type: none"> • Dirt on the sensors • Heavy precipitation • Extended country driving without other traffic, e.g. in the desert <p data-bbox="502 766 852 790">The following systems may be affected:</p> <ul data-bbox="510 797 973 890" style="list-style-type: none"> • Active Distance Assist DISTRONIC (→ page 152) • Blind Spot Assist (→ page 165) • Active Brake Assist (→ page 147) <p data-bbox="502 908 1115 956">Driving systems and driving safety systems may be malfunctioning or temporarily unavailable.</p> <p data-bbox="502 967 1115 1016">When the causes have been eliminated, the driving systems and driving safety systems will be available again.</p> <p data-bbox="502 1025 881 1048">If the display message does not disappear:</p> <ul data-bbox="502 1057 947 1182" style="list-style-type: none"> ► Stop in accordance with the traffic conditions. ► Clean all sensors (→ page 222). ► Restart the vehicle. ► If necessary, consult a qualified specialist workshop.
 <p data-bbox="207 1286 236 1309">Off</p>	<p data-bbox="484 1198 1112 1247">* The HOLD function has been deactivated because the vehicle is slipping or an activation condition has not been met.</p> <ul data-bbox="502 1254 1102 1308" style="list-style-type: none"> ► Reactivate the HOLD function later on or check the HOLD function's activation conditions (→ page 155).
<p data-bbox="207 1335 427 1383">Traffic Sign Assist Inoperative</p>	<p data-bbox="484 1335 822 1358">* Traffic Sign Assist is malfunctioning.</p> <ul data-bbox="502 1365 888 1388" style="list-style-type: none"> ► Consult a qualified specialist workshop.
<p data-bbox="207 1406 427 1478">Traffic Sign Assist Camera View Restricted See Operator's Manual</p>	<p data-bbox="484 1406 921 1430">* The camera view is restricted. Possible causes:</p> <ul data-bbox="510 1437 1000 1496" style="list-style-type: none"> • Dirt on the windshield in the camera's field of vision • Heavy precipitation or fog <p data-bbox="502 1514 1115 1562">Driving systems and driving safety systems may be malfunctioning or temporarily unavailable.</p>





Display messages	Possible causes/consequences and ► Solutions
	<p>When the causes have been eliminated, the driving systems and driving safety systems will be available again.</p> <p>If the display message does not disappear:</p> <ul style="list-style-type: none"> ► Stop in accordance with the traffic conditions. ► Clean the windshield.
<p>Traffic Sign Assist Currently Unavailable See Operator's Manual</p>	<ul style="list-style-type: none"> * Traffic Sign Assist is temporarily unavailable (→ page 163). <ul style="list-style-type: none"> ► Drive on. When the causes have been eliminated, the system will be available again. * The windshield is dirty. Clean the windshield.
<p>Blind Spot Assist Inoperative</p>	<ul style="list-style-type: none"> * Blind Spot Assist is malfunctioning (→ page 165). <ul style="list-style-type: none"> ► Consult a qualified specialist workshop.
<p>Blind Spot Assist Trailer Not Monitored</p>	<ul style="list-style-type: none"> * When you establish an electrical connection with the trailer, Blind Spot Assist will remain available but the area beside the trailer will not be monitored. The function of Blind Spot Assist may be restricted as a result (→ page 165). <ul style="list-style-type: none"> ► Press the left-hand Touch Control and acknowledge the display message.
<p>Blind Spot Assist Currently Unavailable See Operator's Manual</p>	<ul style="list-style-type: none"> * Blind Spot Assist is temporarily unavailable (→ page 165). The system limits have been reached (→ page 165). <ul style="list-style-type: none"> ► Drive on. When the causes have been eliminated, the system will be available again. or ► If the display message does not disappear, stop the vehicle in accordance with the traffic conditions and restart it. ► If necessary, clean the rear bumper. If the bumper is very dirty, the sensors in the bumper may malfunction.
<p>Active Lane Keeping Assist Camera View Restricted See Operator's Manual</p>	<ul style="list-style-type: none"> * The camera view is restricted (→ page 168). Possible causes: <ul style="list-style-type: none"> • Dirt on the windshield in the camera's field of vision • Heavy precipitation or fog <p>Driving systems and driving safety systems may be malfunctioning or temporarily unavailable.</p> <p>When the causes have been eliminated, the driving systems and driving safety systems will be available again.</p> <p>If the display message does not disappear:</p> <ul style="list-style-type: none"> ► Stop in accordance with the traffic conditions. ► Clean the windshield.
<p>Active Lane Keeping Assist Inoperative</p>	<ul style="list-style-type: none"> * Active Lane Keeping Assist is malfunctioning (→ page 168). <ul style="list-style-type: none"> ► Consult a qualified specialist workshop.



Display messages	Possible causes/consequences and ► Solutions
<p>Active Lane Keeping Assist Currently Unavailable See Operator's Manual</p>	<ul style="list-style-type: none"> * Active Lane Keeping Assist is temporarily unavailable (→ page 168). The ambient conditions are outside the system limits (→ page 168). ► Drive on. When the ambient conditions are within the system limits, the system will be available again. If the display message does not disappear: <ul style="list-style-type: none"> ► Stop in accordance with the traffic conditions. ► Clean the windshield.
 <p>Attention Assist Inoperative</p>	<ul style="list-style-type: none"> * ATTENTION ASSIST is malfunctioning. ► Consult a qualified specialist workshop.
 <p>Attention Assist: Take a Break!</p>	<ul style="list-style-type: none"> * ATTENTION ASSIST has detected fatigue or increasing inattentiveness on the driver's part (→ page 162). ► If necessary, take a break.
<p>120 km/h 120 km/h Maximum Speed Exceeded</p>	<ul style="list-style-type: none"> * For certain countries only: the maximum permissible speed has been exceeded. ► Drive more slowly.

Engine

Display messages	Possible causes/consequences and ► Solutions
 <p>Reserve Fuel</p>	<ul style="list-style-type: none"> * The fuel supply has dropped into the reserve range. ► Refuel.
 <p>Replace Air Filter</p>	<ul style="list-style-type: none"> * Vehicles with a diesel engine: the engine air filter is clogged and must be replaced. ► Consult a qualified specialist workshop.
	<ul style="list-style-type: none"> * The fan motor is defective. ► Avoiding high engine loads, drive on to the nearest qualified specialist workshop. In doing so, ensure that the coolant temperature display remains below 248 °F (120 °C).
 <p>Clean Fuel Filter</p>	<ul style="list-style-type: none"> * The fuel filter is dirty and must be replaced or the amount of water accumulated in the fuel filter has reached the maximum fill level. If there is no drain valve ► Consult a qualified specialist workshop.



Display messages	Possible causes/consequences and ► Solutions
	<p>If there is a drain valve</p> <ul style="list-style-type: none"> ► Drain the fuel filter (→ page 220).
 <p>Engine Oil Level Cannot Be Measured</p>	<p>* The electrical connection to the oil level sensor has been interrupted or the oil level sensor is faulty.</p> <ul style="list-style-type: none"> ► Consult a qualified specialist workshop.
 <p>Engine Oil Pressure Stop Vehicle Switch Off Engine</p>	<p>* The oil pressure is too low.</p> <div style="border: 1px solid black; padding: 5px; margin-bottom: 10px;"> <p>! NOTE Engine damage caused by driving with insufficient oil pressure</p> <p>► Avoid driving with insufficient oil pressure.</p> </div> <ul style="list-style-type: none"> ► Stop the vehicle immediately in accordance with the traffic conditions. Do not continue driving! ► Check the engine oil level. <p>Add engine oil (→ page 217). Observe the notes on engine oil (→ page 275).</p> <ul style="list-style-type: none"> ► Contact a qualified specialist workshop.
 <p>Add 1 Liter Engine Oil When Next Refueling</p>	<p>* The engine oil level has fallen to the minimum level.</p> <div style="border: 1px solid black; padding: 5px; margin-bottom: 10px;"> <p>! NOTE Engine damage caused by driving with insufficient engine oil</p> <p>► Avoid long journeys with insufficient engine oil.</p> </div> <ul style="list-style-type: none"> ► Check the engine oil level at the next refueling stop. <p>Add engine oil (→ page 217). Observe the notes on engine oil (→ page 275).</p>
 <p>Engine Oil Level Reduce Oil Level</p>	<p>* The engine oil level is too high.</p> <div style="border: 1px solid black; padding: 5px; margin-bottom: 10px;"> <p>! NOTE Engine damage caused by driving with excess engine oil</p> <p>► Avoid long journeys with excess engine oil.</p> </div> <ul style="list-style-type: none"> ► Visit a qualified specialist workshop immediately and have the engine oil extracted.
 <p>Engine Oil Level Stop Vehicle Switch off Engine</p>	<p>* The engine oil level is too low.</p> <div style="border: 1px solid black; padding: 5px; margin-bottom: 10px;"> <p>! NOTE Engine damage caused by driving with insufficient engine oil</p> <p>► Avoid long journeys with insufficient engine oil.</p> </div> <ul style="list-style-type: none"> ► Stop the vehicle immediately in accordance with the traffic conditions. Do not continue driving! ► Switch off the vehicle.

Display messages	Possible causes/consequences and ► Solutions
	<ul style="list-style-type: none"> ► Check the engine oil level. <p>Add engine oil (→ page 217).</p> <p>Observe the notes on engine oil (→ page 275).</p>
 <p>Check Engine Oil At Next Refueling</p>	<p>* The engine oil level has fallen to the minimum level.</p> <div style="border: 1px solid black; padding: 5px;"> <p>! NOTE Engine damage caused by driving with insufficient engine oil</p> <ul style="list-style-type: none"> ► Avoid long journeys with insufficient engine oil. </div> <ul style="list-style-type: none"> ► Check the engine oil level at the next refueling stop. <p>Add engine oil (→ page 217).</p> <p>Observe the notes on engine oil (→ page 275).</p>
 <p>Stop Vehicle Leave Engine Running</p>	<p>* The battery's state of charge is too low.</p> <ul style="list-style-type: none"> ► Stop the vehicle immediately in accordance with the traffic conditions. Do not continue driving! ► Leave the vehicle running. ► Do not continue driving until the display message goes out.
 <p>Stop Vehicle See Operator's Manual</p>	<p>* The battery is no longer being charged and has reached an excessively low state of charge.</p> <div style="border: 1px solid black; padding: 5px;"> <p>! NOTE Possible engine damage if you continue driving</p> <ul style="list-style-type: none"> ► Do not continue driving under any circumstances. ► Consult a qualified specialist workshop. </div> <ul style="list-style-type: none"> ► Stop the vehicle immediately in accordance with the traffic conditions. Do not continue driving! ► Switch off the vehicle. ► Contact a qualified specialist workshop.
 <p>Start Engine See Operator's Manual</p>	<p>* The vehicle has not started and the battery's state of charge is too low.</p> <ul style="list-style-type: none"> ► Switch off electrical consumers that are not required. ► Leave the vehicle running for a few minutes, or drive an extended distance. The battery will be charged.
 <p>See Operator's Manual</p>	<p>* The battery is no longer being charged.</p> <div style="border: 1px solid black; padding: 5px;"> <p>! NOTE Possible engine damage if you continue driving</p> <ul style="list-style-type: none"> ► Do not continue driving under any circumstances. ► Consult a qualified specialist workshop. </div> <ul style="list-style-type: none"> ► Stop the vehicle immediately in accordance with the traffic conditions and switch it off. ► Contact a qualified specialist workshop.

Display messages	Possible causes/consequences and ► Solutions
 <p data-bbox="185 351 380 399">Coolant Stop Vehicle Switch Off Engine</p>	<p data-bbox="461 259 679 283">* The coolant is too hot.</p> <ul style="list-style-type: none"> <li data-bbox="481 290 1097 342">► Stop the vehicle immediately in accordance with the traffic conditions and switch it off. <div data-bbox="481 369 1097 664" style="border: 1px solid gray; padding: 5px;"> <p data-bbox="492 374 964 401">▲ WARNING Risk of burns when opening the hood</p> <p data-bbox="492 412 1069 464">If you open the hood in the event of an overheated engine or fire in the engine compartment, the following situations may occur:</p> <ul style="list-style-type: none"> <li data-bbox="504 474 911 498">• You may come into contact with hot gases. <li data-bbox="504 507 1080 559">• You may come into contact with other escaping hot operating fluids. <ul style="list-style-type: none"> <li data-bbox="497 569 1031 596">► Before opening the hood, allow the engine to cool down. <li data-bbox="497 605 1044 657">► In the event of a fire in the engine compartment, keep the hood closed and call the fire service. </div> <div data-bbox="481 686 1097 885" style="border: 1px solid gray; padding: 5px;"> <p data-bbox="492 691 929 718">▲ WARNING Risk of scalding from hot coolant</p> <p data-bbox="492 727 898 754">If you open the cap, you could scald yourself.</p> <ul style="list-style-type: none"> <li data-bbox="497 763 1014 790">► Allow the engine to cool down before opening the cap. <li data-bbox="497 799 1038 851">► When opening the cap, wear protective gloves and safety glasses. <li data-bbox="497 860 892 885">► Open the cap slowly to release pressure. </div> <ul style="list-style-type: none"> <li data-bbox="481 903 856 930">► Wait until the engine has cooled down. <li data-bbox="481 939 1034 965">► Ensure that the air supply to the radiator is not obstructed. <li data-bbox="481 974 1097 1048">► Avoiding high engine loads, drive on to the nearest qualified specialist workshop. In doing so, ensure that the coolant temperature display remains below 248°F (120°C).
 <p data-bbox="185 1152 418 1200">Refill Coolant See Operator's Manual</p>	<p data-bbox="461 1060 725 1084">* The coolant level is too low.</p> <div data-bbox="481 1102 1097 1300" style="border: 1px solid gray; padding: 5px;"> <p data-bbox="492 1107 929 1134">▲ WARNING Risk of scalding from hot coolant</p> <p data-bbox="492 1145 898 1171">If you open the cap, you could scald yourself.</p> <ul style="list-style-type: none"> <li data-bbox="497 1180 1014 1207">► Allow the engine to cool down before opening the cap. <li data-bbox="497 1216 1038 1268">► When opening the cap, wear protective gloves and safety glasses. <li data-bbox="497 1277 892 1302">► Open the cap slowly to release pressure. </div> <div data-bbox="481 1322 1097 1403" style="border: 1px solid gray; padding: 5px;"> <p data-bbox="492 1327 968 1354">! NOTE Engine damage due to insufficient coolant</p> <ul style="list-style-type: none"> <li data-bbox="497 1363 929 1390">► Avoid long journeys with insufficient coolant. </div> <ul style="list-style-type: none"> <li data-bbox="481 1417 760 1444">► Add coolant (→ page 218).
<p data-bbox="185 1458 382 1510">Manual Regeneration Not Possible</p>	<p data-bbox="461 1460 1097 1512">* Not all conditions have been met for regeneration of the diesel particulate filter (→ page 122).</p> <ul style="list-style-type: none"> <li data-bbox="481 1521 1087 1573">► Continue driving as normal until all conditions have been met for regeneration of the diesel particulate filter.





Display messages	Possible causes/consequences and ► Solutions
	<p>The load condition of the diesel particulate filter is over 50% and the message still appears on the instrument cluster.</p> <p>► Consult a qualified specialist workshop.</p>



Tires

Display messages	Possible causes/consequences and ► Solutions
<p>Tire Pressure Monitor Inoperative No Wheel Sensors</p>	<p>* The wheels installed do not have suitable tire pressure sensors. The tire pressure monitoring system is deactivated.</p> <p>► Install wheels with suitable tire pressure sensors.</p>
 <p>Wheel Sensor(s) Missing</p>	<p>* There is no signal from the tire pressure sensor of at least one tire. No pressure value is displayed for the tire in question.</p> <p>► Have the faulty tire pressure sensor replaced at a qualified specialist workshop.</p>
<p>Tire Press. Monitor Currently Unavailable</p>	<p>* There is interference from a powerful radio signal source. As a result, no signals from the tire pressure sensor are received. The tire pressure monitoring system is temporarily unavailable.</p> <p>► Drive on. The tire pressure monitoring system will restart automatically as soon as the cause has been rectified.</p>
 <p>Warning Tire Malfunction</p>	<p>* The tire pressure in one or more tires has dropped suddenly. The wheel position is shown.</p> <div style="border: 1px solid gray; padding: 5px;"> <p>▲ WARNING Risk of an accident from driving with a flat tire</p> <ul style="list-style-type: none"> • The tires can overheat and cause a fire. • The driving characteristics as well as the steering and braking may be greatly impaired. <p>You could then lose control of the vehicle.</p> <p>► Do not drive on with a flat tire.</p> <p>► Observe the notes on flat tires.</p> </div> <p>Information about flat tire (→ page 228).</p> <p>► Stop the vehicle in accordance with the traffic conditions.</p> <p>► Check the tires.</p>
 <p>Check Tires</p>	<p>* The tire pressure in one or more tires has dropped significantly. The wheel position is shown.</p> <div style="border: 1px solid gray; padding: 5px;"> <p>▲ WARNING Risk of an accident due to insufficient tire pressure</p> <ul style="list-style-type: none"> • The tires can burst. • The tires can wear excessively and/or unevenly. • The driving characteristics as well as the steering and braking may be greatly impaired. <p>You could then lose control of the vehicle.</p> </div>





Display messages	Possible causes/consequences and ► Solutions
	<ul style="list-style-type: none"> ► Observe the recommended tire pressures. ► Adjust the tire pressure if necessary. <ul style="list-style-type: none"> ► Stop in accordance with the traffic conditions. ► Check the tire pressure (→ page 240) and the tires.
 <p>Please Correct Tire Pressure</p>	<ul style="list-style-type: none"> * The tire pressure is too low in at least one tire, or the difference in tire pressure between the individual wheels is too great. ► Check the tire pressure, and add air if necessary. ► When the tire pressure has been set correctly, re-start the tire pressure monitoring system (→ page 246).
<p>Tire Pressure Monitor Inoperative</p>	<ul style="list-style-type: none"> * The tire pressure monitoring system is malfunctioning. ► Consult a qualified specialist workshop.





Key

Display messages	Possible causes/consequences and ► Solutions
 <p>Don't Forget Your Key</p>	<ul style="list-style-type: none"> * This message reminds you not to leave your key in the vehicle. ► Take the key with you when you get out of the vehicle.
 <p>Place Key in Marked Space See Operator's Manual</p>	<ul style="list-style-type: none"> * Key detection is malfunctioning. ► Change the key's position in the vehicle. ► Start the vehicle with the key in the marked space (→ page 112).
 <p>Key Not Detected (red display message)</p>	<ul style="list-style-type: none"> * The key is not detected and may no longer be in the vehicle. <p>The key is no longer in the vehicle and you switch off the vehicle:</p> <ul style="list-style-type: none"> • You can no longer start the vehicle. • You cannot lock the vehicle centrally. <ul style="list-style-type: none"> ► Ensure that the key is in the vehicle. <p>If the key detection function is malfunctioning due to a strong radio signal source, proceed as follows:</p> <ul style="list-style-type: none"> ► Stop the vehicle immediately in accordance with the traffic conditions. ► Place the key in the slot for starting with the key (→ page 112).
 <p>Key Not Detected (white display message)</p>	<ul style="list-style-type: none"> * The key is currently not detected. ► Change the key's position in the vehicle. ► If the key is still not detected, start the vehicle with the key in the slot (→ page 112).



Display messages	Possible causes/consequences and ► Solutions
 <p>Replace Key Battery</p>	<ul style="list-style-type: none"> * The key battery is flat. <ul style="list-style-type: none"> ► Replace the battery (→ page 50).
 <p>Obtain a New Key</p>	<ul style="list-style-type: none"> * The key needs to be replaced. <ul style="list-style-type: none"> ► Consult a qualified specialist workshop.

Vehicle

Display messages	Possible causes/consequences and ► Solutions
<p>Risk of rolling, driver's seat not occupied and transmission not in P</p>	<ul style="list-style-type: none"> * The driver's seat detection system has not detected anyone in the driver's seat and the transmission is in position [R], [N] or [D]. <ul style="list-style-type: none"> ► When parking the vehicle and leaving the driver's seat, shift the transmission into position [P] and also secure the vehicle with the parking brake.
 <p>Refill Washer Fluid</p>	<ul style="list-style-type: none"> * The washer fluid level in the washer fluid reservoir has dropped below the minimum. <ul style="list-style-type: none"> ► Add washer fluid (→ page 219). <p>If the display message still appears:</p> <ul style="list-style-type: none"> ► Consult a qualified specialist workshop.
	<ul style="list-style-type: none"> * At least one door is open. <ul style="list-style-type: none"> ► Close all the doors.
	<ul style="list-style-type: none"> * The hood is open. <div style="border: 1px solid black; padding: 5px; margin: 5px 0;"> <p>⚠ WARNING Risk of accident due to driving with the hood unlocked</p> <p>The hood may open and block your view.</p> <ul style="list-style-type: none"> ► Never release the hood when driving. ► Before every trip, ensure that the hood is locked. </div> <ul style="list-style-type: none"> ► Stop the vehicle immediately in accordance with the traffic conditions. ► Close the hood.
 <p>Inoperative See Operator's Manual</p>	<ul style="list-style-type: none"> * The stationary heater is temporarily malfunctioning. <ul style="list-style-type: none"> ► When the vehicle is at a standstill in a horizontal position and the engine has cooled down: try to switch on the stationary heater four times, leaving a gap of several minutes between each attempt. ► If the stationary heater does not switch on: consult a qualified specialist workshop.







Display messages	Possible causes/consequences and ► Solutions
 <p>Inoperative Refuel Vehicle</p>	<p>* There is too little fuel in the fuel tank. The stationary heater cannot be switched on.</p> <ul style="list-style-type: none"> ► Refuel the vehicle.
 <p>Inoperative Battery Low</p>	<p>* The on-board electrical system voltage is too low. The stationary heater has switched off.</p> <ul style="list-style-type: none"> ► Drive an extended distance until the battery has been sufficiently charged again.
 <p>Steering Malfunction Increased Physical Effort See Operator's Manual</p>	<p>* The steering power assistance is malfunctioning.</p> <div style="border: 1px solid black; padding: 5px; margin-bottom: 10px;"> <p>▲ WARNING Risk of an accident due to altered steering characteristics</p> <p>If the power assistance of the steering fails partially or completely, you will need to use more force to steer.</p> <ul style="list-style-type: none"> ► If safe steering is possible, drive on carefully. ► Visit or consult a qualified specialist workshop immediately. </div> <ul style="list-style-type: none"> ► If safe steering is possible, drive on carefully. ► Visit or consult a qualified specialist workshop immediately.
 <p>Steering Malfunction Stop Immediately See Operator's Manual</p>	<p>* The steering is malfunctioning. Steerability is heavily impaired.</p> <div style="border: 1px solid black; padding: 5px; margin-bottom: 10px;"> <p>▲ WARNING Risk of accident if steering capability is impaired</p> <p>If the steering does not function as intended, the vehicle's operating safety is jeopardized.</p> <ul style="list-style-type: none"> ► Pull over and stop the vehicle safely as soon as possible, paying attention to road and traffic conditions. Do not continue driving under any circumstances. ► Consult a qualified specialist workshop. </div> <ul style="list-style-type: none"> ► Stop the vehicle immediately in accordance with the traffic conditions. Do not continue driving! ► Contact a qualified specialist workshop.
<p>Shift to 'P' or 'N' to Start Engine</p>	<p>* You have attempted to start the vehicle in transmission position D or R.</p> <ul style="list-style-type: none"> ► Select transmission position P or N.
<p>To Engage Transmiss. Position R First Depress the Brake</p>	<p>* You have attempted to shift from position D or N to position R.</p> <ul style="list-style-type: none"> ► Depress the brake pedal. ► Shift the transmission to position R.
<p>Air Conditioning Malfunction See Operator's Manual</p>	<p>* The function of the climate control system is temporarily restricted. The quantity of air and flow of fresh air are controlled automatically.</p> <ul style="list-style-type: none"> ► Have the climate control system checked at a qualified specialist workshop.

Display messages	Possible causes/consequences and ► Solutions
Auxiliary Battery Malfunction	<ul style="list-style-type: none"> * The auxiliary battery for the transmission is no longer being charged. <ul style="list-style-type: none"> ► Consult a qualified specialist workshop. ► Until then, always shift the transmission to position P manually before you switch off the engine. ► Before leaving the vehicle, apply the parking brake.
Reversing Not Possible: Service Required	<ul style="list-style-type: none"> * The transmission is malfunctioning. It is no longer possible to select reverse gear. <ul style="list-style-type: none"> ► Consult a qualified specialist workshop.
Transmission Malfunction Stop	<ul style="list-style-type: none"> * The transmission is malfunctioning. The transmission automatically shifts to position N. <ul style="list-style-type: none"> ► Stop the vehicle immediately in accordance with the traffic conditions. ► Shift the transmission to position P. ► Contact a qualified specialist workshop.
 <p>Vehicle Operational Switch the Ignition Off Before Exiting</p>	<ul style="list-style-type: none"> * You are about to exit the vehicle when it is in a ready-to-drive state. <ul style="list-style-type: none"> ► When you exit the vehicle, switch off the vehicle and take the key with you. ► If you do not exit the vehicle, switch off the electrical consumers, e.g. the seat heating. Otherwise, the 12 V battery may discharge and it will be possible to start the vehicle only with the aid of a second battery (starting assistance).
Do Not Change Transmission Position Service Required	<ul style="list-style-type: none"> * The transmission is malfunctioning or there is a malfunction in the high-voltage on-board electrical system. <ul style="list-style-type: none"> ► If transmission position D is selected, consult a qualified specialist workshop and do not change the transmission position. ► For all other transmission positions, park the vehicle in a safe location. ► Inform a qualified specialist workshop or breakdown service.
Only Shift to 'P' when Vehicle is Stationary	<ul style="list-style-type: none"> * The transmission can be shifted to position P only when the vehicle is at a standstill.
N Permanently Active Risk of Rolling Away	<ul style="list-style-type: none"> * While the vehicle is rolling or driving, the transmission was shifted to position N. <ul style="list-style-type: none"> ► To stop, depress the brake pedal and, when the vehicle is at a standstill, shift the transmission to position P. ► To continue your journey, shift the transmission to position D or R.
Risk of Rolling Driver's Door Open and Transmission Not in P	<ul style="list-style-type: none"> * The driver's door is not fully closed and the transmission is in position R, N or D. <ul style="list-style-type: none"> ► When you park the vehicle, shift the transmission to P and use the parking brake to secure the vehicle additionally.
Apply Brake to Shift from 'P'	<ul style="list-style-type: none"> * You have attempted to shift out of drive range P and into another drive range. <ul style="list-style-type: none"> ► Depress the brake pedal.

Display messages	Possible causes/consequences and ► Solutions
 <p>Veh. Tracking Activated See Op. Manual or mobile app</p>	<p>* The vehicle has activated services from Mercedes me at its disposal. Locating the vehicle may be possible using Mercedes me connect.</p> <ul style="list-style-type: none"> ► Check the status of the activated services at http://mercedes.me. ► Ask the vehicle owner for the details. ► Vehicles with MBUX and navigation: deactivate Vehicle Tracker via the system settings.
 <p>Step Not Extended See Operator's Manual or step not extended mal- function</p>	<p>* The electrical step is not extended, or is only partially extended.</p> <ul style="list-style-type: none"> ► Ensure there is sufficient clearance for the electric step. ► Open or close the sliding door again. ► If the electrical step does not completely extend again, push it in manually (emergency release) (→ page 63). ► Inform passengers that the step is missing before they exit the vehicle.
 <p>Step Not Retracted See Operator's Manual or step not retracted mal- function</p>	<p>* The electric step is not retracted, or is only partially retracted.</p> <ul style="list-style-type: none"> ► Ensure there is sufficient clearance for the electric step. ► Open or close the sliding door again. ► If the electric step does not completely retract again, push it in manually (emergency release) (→ page 63).

Lights









Display messages	Possible causes/consequences and ► Solutions
<p>Adaptive Highbeam Assist Camera View Restricted See Opera- tor's Manual</p>	<p>* The camera view is restricted. Possible causes:</p> <ul style="list-style-type: none"> • dirt on the windshield in the camera's field of vision • heavy precipitation or fog <p>Driving systems and driving safety systems may be malfunctioning or temporarily unavailable.</p> <p>When the causes have been eliminated, the driving systems and driving safety systems will be available again.</p> <p>If the display message does not disappear:</p> <ul style="list-style-type: none"> ► Stop in accordance with the traffic conditions. ► Clean the windshield.
<p>Adaptive Highbeam Assist Currently Unavail- able See Operator's Man- ual</p>	<p>* Adaptive Highbeam Assist is temporarily unavailable. The system limits have been reached (→ page 89).</p> <ul style="list-style-type: none"> ► Drive on. When the causes have been eliminated, the system will be available again. The display message Adaptive Highbeam Assist Now Available appears.
<p>Adaptive Highbeam Assist Inoperative</p>	<p>* Adaptive Highbeam Assist is malfunctioning.</p> <ul style="list-style-type: none"> ► Consult a qualified specialist workshop.













Display messages	Possible causes/consequences and ► Solutions
 Switch On Headlamps	* You are driving without low beam. ► Turn the light switch to the  position. or ► Turn the light switch to the AUTO position.
 Switch Off Lights	* You are leaving the vehicle and the light is still switched on. ► Turn the light switch to the AUTO position.
 AUTO Lamp Function Inoperative	* The light sensor is malfunctioning. ► Consult a qualified specialist workshop.
 Malfunction See Operator's Manual	* The exterior lighting is malfunctioning. ► Consult a qualified specialist workshop. * Vehicles with trailer hitch: a fuse may have blown. ► Stop in accordance with the traffic conditions. ► Check the fuses, and replace them if necessary(→ page 233).
 Low Beam Left (example)	* The corresponding light source is defective. ► Consult a qualified specialist workshop. or ► Check whether changing the bulb is permitted.







Indicator and warning lamps
Overview of indicator and warning lamps

Some systems will perform a self-test when the vehicle is switched on. Some indicator and warning lamps may briefly light up or flash. This behavior is non-critical. These indicator and warning lamps indicate a malfunction only if they light up or flash after the vehicle has been started or during a journey.





Indicator and warning lamps:

-  Low beam (→ page 87)
-  Standing lights (→ page 87)
-  High beam (→ page 88)
-   Turn signal lights (→ page 88)
-  Rear fog light (→ page 87)
-  Seat belt not fastened (→ page 311)
- BRAKE** and  USA: Brakes (red) (→ page 305)









-  Canada: Brakes (red) (→ page 305)
-  Brakes (yellow) (→ page 305)
-  ABS malfunction (→ page 305)
-  Off-road gear
-  ESP® (→ page 305)
-  ESP® OFF (→ page 305)
-  Active Brake Assist switched off (→ page 147)
- PARK** and  USA: Electric parking brake applied (red) (→ page 305)
-  Canada: Electric parking brake applied (red) (→ page 305)
-  Electric parking brake (yellow) (→ page 305)
-  Electric power steering malfunction (→ page 311)
-  Electrical malfunction (→ page 312)
-  Restraint system (→ page 305)



-  Engine diagnosis (→ page 312)
-  Fuel reserve with fuel filler cap location indicator (→ page 312)
-  Coolant too hot/cold (→ page 312)
-  Distance warning (→ page 311)
-  Preglow
-  Tire pressure monitoring system (→ page 244)







Safety systems



Warning/indicator lamp	Possible causes/consequences and ► Solutions
 and  Electric parking brake applied red indicator lamp (USA) does not light up	<p>*Vehicles with electric parking brake: the red electric parking brake indicator lamp does not light up. The yellow electric parking brake indicator lamp lights up.</p> <p>Meaning of the indicator lamps:</p> <ul style="list-style-type: none"> • The red indicator lamp does not light up: the electric parking brake has been released. • The yellow indicator lamp lights up: the electric parking brake is malfunctioning. <ul style="list-style-type: none"> ► Note the messages on the instrument cluster. ► Switch the vehicle off and on. ► If the fault message persists, consult a qualified specialist workshop. ► Park the vehicle only on level ground and secure it against rolling away (→ page 141).
 Electric parking brake applied red indicator lamp (Canada) does not light up	
 Electric parking brake malfunctioning yellow indicator lamp lights up	

Warning/indicator lamp	Possible causes/consequences and ► Solutions
 <p>and</p>  <p>Red electric parking brake applied indicator lamp (USA) lights up</p>  <p>Red electric parking brake applied indicator lamp (Canada) lights up</p>  <p>Electric parking brake malfunctioning yellow indicator lamp lights up</p>	<p>*Vehicles with electric parking brake: the red and yellow electric parking brake indicator lamps light up.</p> <p>Meaning of the indicator lamps:</p> <ul style="list-style-type: none"> • The red electric parking brake indicator lamp lights up: the electric parking brake has been applied. • The yellow electric parking brake indicator lamp lights up: the electric parking brake is malfunctioning. <ul style="list-style-type: none"> ► Note the messages on the instrument cluster. ► Switch the vehicle off and on. ► If the fault message persists, consult a qualified specialist workshop. ► If it is not possible to release the electric parking brake, do not drive the vehicle.
 <p>and</p>  <p>Red electric parking brake applied indicator lamp (USA) flashes</p>  <p>Red electric parking brake applied indicator lamp (Canada) flashes</p>  <p>Electric parking brake malfunctioning yellow indicator lamp lights up</p>	<p>*Vehicles with electric parking brake: the red electric parking brake indicator lamp flashes. The yellow electric parking brake indicator lamp lights up.</p> <p>Meaning of the indicator lamps:</p> <ul style="list-style-type: none"> • The red electric parking brake indicator lamp flashes: the activation status of the electric parking brake is unknown. • The yellow electric parking brake indicator lamp lights up: the electric parking brake is malfunctioning. <ul style="list-style-type: none"> ► Note the messages on the instrument cluster. ► Switch the vehicle off and on. ► Engage and release the electric parking brake using the switch while depressing the brake pedal. ► If the fault message persists, park the vehicle on level ground and secure it against rolling away (→ page 141). ► Consult a qualified specialist workshop. ► Do not drive the vehicle when the red indicator lamp is flashing, as the brake system may overheat.



Warning/indicator lamp	Possible causes/consequences and ► Solutions
 <p>and</p>  <p>Red electric parking brake applied indicator lamp (USA) lights up</p>  <p>Red electric parking brake applied indicator lamp (Canada) lights up</p>  <p>The electric parking brake malfunctioning yellow indicator lamp does not light up</p>	<p>*Vehicles with electric parking brake: the electric parking brake red indicator lamp lights up. The electric parking brake yellow indicator lamp does not light up.</p> <p>Meaning of the indicator lamps:</p> <ul style="list-style-type: none"> • The electric parking brake red indicator lamp lights up: the electric parking brake has been applied. • The electric parking brake yellow indicator lamp does not light up: there are no faults with the electric parking brake. <p>► Do not drive the vehicle if the electric parking brake has been applied.</p>
 <p>and</p>  <p>Red parking brake applied indicator lamp (USA) lights up</p>  <p>Red parking brake applied indicator lamp (Canada) lights up</p>	<p>*Vehicles with manual parking brake: the parking brake red indicator lamp lights up.</p> <p>Meaning of the indicator lamp:</p> <ul style="list-style-type: none"> • The parking brake red indicator lamp lights up: the parking brake has been applied. <p>► Do not drive the vehicle if the parking brake has been applied.</p>
 <p>Brake system warning lamp (yellow)</p>	<p>*The yellow brakes warning lamp lights up while the vehicle is switched on.</p> <p>▲ WARNING Risk of an accident due to a brake system malfunction</p> <p>If the brake system is malfunctioning, braking characteristics may be impaired.</p> <p>► Drive on carefully.</p>

Warning/indicator lamp	Possible causes/consequences and ► Solutions
	<ul style="list-style-type: none"> ► Have the brake system checked immediately at a qualified specialist workshop. ► Drive on carefully at an adjusted speed and at a sufficient distance from the vehicle in front. ► If the instrument cluster shows a display message, comply with it. ► Consult a qualified specialist workshop.
<div style="display: flex; flex-direction: column; align-items: center;">  <p>and</p>  <p>Brake warning lamp (red) (USA)</p>  <p>Brake warning lamp (red) (Canada)</p> </div>	<p>*The red brakes warning lamp lights up while the vehicle is on.</p> <p>Possible causes:</p> <ul style="list-style-type: none"> • The brake force boosting is malfunctioning. • The EBD (electronic brake force distribution) is malfunctioning. • There is insufficient brake fluid in the brake fluid reservoir. <div style="background-color: #f0f0f0; padding: 5px; margin-bottom: 10px;"> <p>▲ WARNING Risk of accident and injury if brake force boosting is malfunctioning</p> <p>If brake force boosting is malfunctioning, increased brake pedal force may be necessary for braking. The braking characteristics may be impaired. The braking distance can increase in emergency braking situations.</p> <ul style="list-style-type: none"> ► Stop in a safe location immediately. Do not continue driving. ► Consult a qualified specialist workshop. </div> <div style="background-color: #f0f0f0; padding: 5px; margin-bottom: 10px;"> <p>▲ WARNING Risk of an accident if the EBD (electronic brake force distribution) malfunctions</p> <p>If the EBD malfunctions, the wheels may lock during braking. The braking characteristics may be impaired. The braking distance can increase in emergency situations.</p> <ul style="list-style-type: none"> ► Stop in a safe location immediately. Do not continue driving. ► Consult a qualified specialist workshop. </div> <div style="background-color: #f0f0f0; padding: 5px; margin-bottom: 10px;"> <p>▲ WARNING Risk of an accident due to low brake fluid level</p> <p>If the brake fluid level is too low, the braking effect and the braking characteristics may be impaired.</p> <ul style="list-style-type: none"> ► Pull over and stop the vehicle safely as soon as possible, paying attention to road and traffic conditions. Do not continue driving under any circumstances. ► Consult a qualified specialist workshop. ► Do not add brake fluid. </div> <ul style="list-style-type: none"> ► Stop the vehicle immediately in accordance with the traffic conditions. Do not continue driving! ► Consult a qualified specialist workshop.

Warning/indicator lamp	Possible causes/consequences and ► Solutions
 <p>and</p>  <p>Brake warning lamp (red) (USA)</p>	<p>*Only in the USA: The brake system red warning lamp lights up while the engine is on.</p> <p>Possible cause:</p> <ul style="list-style-type: none"> • The brakepads have reached their wear limit. <div style="background-color: #f0f0f0; padding: 5px; border: 1px solid #ccc;"> <p>▲ WARNING Risk of accident due to restricted braking power</p> <p>When the brake pads have reached their wear limit, the braking power may be restricted.</p> <ul style="list-style-type: none"> ► Drive on carefully. ► Have the brake system checked immediately at a qualified specialist workshop. </div> <ul style="list-style-type: none"> ► Drive on carefully. ► Consult a qualified specialist workshop immediately.
 <p>Restraint system warning lamp</p>	<p>*The red restraint system warning lamp is on while the vehicle is switched on. The restraint system is malfunctioning.</p> <div style="background-color: #f0f0f0; padding: 5px; border: 1px solid #ccc;"> <p>▲ WARNING Risk of injury due to malfunctions in the restraint system</p> <p>Components in the restraint system may be activated unintentionally or not deploy as planned in an accident.</p> <ul style="list-style-type: none"> ► Have the restraint system checked and repaired immediately at a qualified specialist workshop. </div> <p>Detection of a restraint system malfunction:</p> <ul style="list-style-type: none"> • The restraint system warning lamp  does not light up when the vehicle is switched on. • The restraint system warning lamp  lights up continuously or repeatedly during a journey. <ul style="list-style-type: none"> ► Drive on carefully. ► Note the messages on the instrument cluster. ► Consult a qualified specialist workshop immediately.
 <p>ESP® warning lamp lights up</p>	<p>*The yellow ESP® warning lamp lights up while the vehicle is switched on. ESP® is malfunctioning and/or has been deactivated automatically. Other driving systems and driving safety systems may also be malfunctioning.</p> <div style="background-color: #f0f0f0; padding: 5px; border: 1px solid #ccc;"> <p>▲ WARNING Risk of skidding if ESP® is malfunctioning</p> <p>If ESP® is malfunctioning, ESP® cannot carry out vehicle stabilization. In addition, other driving safety systems are switched off.</p> <ul style="list-style-type: none"> ► Drive on carefully. ► Have ESP® checked at a qualified specialist workshop. </div>

Warning/indicator lamp	Possible causes/consequences and ► Solutions
	<ul style="list-style-type: none"> ► Drive on carefully. ► Note the messages on the instrument cluster. ► Consult a qualified specialist workshop.
 <p>ESP® warning lamp flashes</p>	<p>*The ESP® yellow warning lamp flashes during a journey. ESP® intervenes (→ page 145).</p> <ul style="list-style-type: none"> ► Adapt your driving style to the weather and road conditions.
 <p>ESP® OFF warning lamp</p>	<p>*The yellow ESP® OFF warning lamp lights up while the vehicle is on. ESP® has been switched off by the driver.</p> <div style="border: 1px solid black; padding: 5px; margin: 5px 0;"> <p>⚠ WARNING Risk of skidding when driving with ESP® deactivated</p> <p>ESP® does not act to stabilize the vehicle. The availability of further driving safety systems is also limited.</p> <ul style="list-style-type: none"> ► Drive on carefully. ► Deactivate ESP® only for as long as the situation requires. <p>If ESP® cannot be activated, ESP® is malfunctioning.</p> <ul style="list-style-type: none"> ► Have ESP® checked immediately at a qualified specialist workshop. </div> <ul style="list-style-type: none"> ► Comply with instructions to switch ESP® off (→ page 145).
 <p>ABS warning lamp</p>	<p>*The yellow ABS warning lamp lights up while the vehicle is switched on. ABS is malfunctioning.</p> <p>If an additional warning tone sounds, this means the EBD is malfunctioning.</p> <p>Other driving systems and driving safety systems may also be malfunctioning.</p> <div style="border: 1px solid black; padding: 5px; margin: 5px 0;"> <p>⚠ WARNING There is a risk of skidding if EBD or ABS is malfunctioning</p> <p>The wheels may lock during braking.</p> <p>The steerability and braking characteristics are heavily impaired and the braking distance may increase. In addition, other driving safety systems are switched off.</p> <ul style="list-style-type: none"> ► Drive on carefully. ► Have the brake system checked immediately at a qualified specialist workshop. </div> <ul style="list-style-type: none"> ► Drive on carefully. ► Note the messages on the instrument cluster. ► Consult a qualified specialist workshop.

Seat belt

Warning/indicator lamp	Possible causes/consequences and ► Solutions
 <p>Seat belt warning lamp flashes</p>	<p>*The red seat belt warning lamp flashes and an intermittent warning tone sounds. The driver or front passenger does not have their belt on while the vehicle is in motion (speeds above 15 mph (25 km/h)).</p> <ul style="list-style-type: none"> ► Put on the seat belt (→ page 35). There are objects on the front passenger seat. ► Remove the objects from the front passenger seat.
 <p>Seat belt warning lamp lights up</p>	<p>*The red seat belt warning lamp lights up after the vehicle has started. A warning tone may also sound. When the vehicle is stationary: the seat belt warning lamp reminds drivers and front passengers to put on their seat belt.</p> <ul style="list-style-type: none"> ► Put on the seat belt (→ page 35). <p>Objects on the front passenger seat may prevent the seat belt warning lamp from going out.</p>



Driving systems



Warning/indicator lamp	Possible causes/consequences and ► Solutions
 <p>Warning lamp for distance warning function</p>	<p>*The red distance warning lamp lights up while you are driving and a warning tone sounds. You are approaching an obstacle at too high a speed.</p> <ul style="list-style-type: none"> ► Be ready to apply the brakes immediately. ► Increase the distance.

Vehicle



Warning/indicator lamp	Possible causes/consequences and ► Solutions
 <p>Electric power steering warning lamp (red)</p>	<p>*The red power steering warning lamp lights up while the vehicle is switched on. The power steering assistance or the steering itself is malfunctioning.</p> <div style="border: 1px solid gray; padding: 5px; margin: 10px 0;"> <p>⚠ WARNING Risk of accident due to impaired steering ability</p> <p>If the steering no longer functions as intended, the operational safety of the vehicle is at risk.</p> <ul style="list-style-type: none"> ► Consult a qualified specialist workshop. </div> <ul style="list-style-type: none"> ► Note the messages on the instrument cluster display.

Engine

Warning/indicator lamp	Possible causes/consequences and ► Solutions
 <p data-bbox="207 390 405 413">Coolant warning lamp</p>	<p data-bbox="475 301 1037 324">* The red coolant warning lamp lights up while the vehicle is on.</p> <p data-bbox="484 336 632 360">Possible causes:</p> <ul data-bbox="493 369 843 491" style="list-style-type: none"> • Temperature sensor malfunctioning • Coolant level too low • Air supply to the radiator obstructed • Radiator fan faulty <p data-bbox="484 508 1106 557">If a warning tone also sounds, the coolant has exceeded the temperature of 248°F (120°C).</p> <div data-bbox="488 575 1123 870" style="border: 1px solid gray; padding: 5px;"> <p data-bbox="497 580 971 605">▲ WARNING Risk of burns when opening the hood</p> <p data-bbox="501 623 1097 672">If you open the hood in the event of an overheated engine or fire in the engine compartment, the following situations may occur:</p> <ul data-bbox="510 682 1084 759" style="list-style-type: none"> • You may come into contact with hot gases. • You may come into contact with other escaping hot operating fluids. <ul data-bbox="501 777 1054 861" style="list-style-type: none"> ► Before opening the hood, allow the engine to cool down. ► In the event of a fire in the engine compartment, keep the hood closed and call the fire service. </div> <ul data-bbox="484 888 1106 974" style="list-style-type: none"> ► Stop the vehicle immediately in accordance with the traffic conditions and switch off the engine. Do not continue driving! ► Note the messages on the instrument cluster. <p data-bbox="484 996 1097 1044">If the coolant temperature display is at the lower end of the temperature scale:</p> <ul data-bbox="484 1053 873 1076" style="list-style-type: none"> ► Contact a qualified specialist workshop. <p data-bbox="484 1103 584 1127">Otherwise:</p> <ul data-bbox="484 1136 1123 1333" style="list-style-type: none"> ► Exit the vehicle and keep a safe distance from it until the engine has cooled down. ► Check the coolant level (→ page 218). ► Ensure that the air supply to the radiator is not obstructed. ► Avoiding high engine loads, drive on to the nearest qualified specialist workshop. In doing so, ensure that the coolant temperature display remains below 248°F (120°C).
 <p data-bbox="207 1442 405 1490">Electrical malfunction warning lamp</p>	<p data-bbox="475 1352 896 1401">* The red electrical fault warning lamp lights up. A malfunction has occurred in the electrics.</p> <ul data-bbox="484 1410 926 1433" style="list-style-type: none"> ► Note the messages on the instrument cluster.

Warning/indicator lamp	Possible causes/consequences and ► Solutions
 <p data-bbox="185 349 422 372">Fuel reserve warning lamp</p>	<p data-bbox="457 259 1080 310">*The yellow fuel reserve warning lamp lights up while the vehicle is on. The fuel supply has dropped into the reserve range.</p> <p data-bbox="464 317 560 340">► Refuel.</p>
 <p data-bbox="185 480 413 530">Engine diagnosis warning lamp</p>	<p data-bbox="457 390 1097 462">*The yellow Check Engine warning lamp lights up while the vehicle is on. A malfunction has occurred in the engine, exhaust system or fuel system.</p> <p data-bbox="464 473 1044 523">This can cause the emissions limit values to be exceeded and the engine to run in emergency mode.</p> <p data-bbox="464 530 1054 580">► Have the vehicle checked at a qualified specialist workshop as quickly as possible.</p>

Tires

Warning/indicator lamp	Possible causes/consequences and ► Solutions
 <p data-bbox="185 806 405 883">Tire pressure monitoring system warning lamp flashes</p>	<p data-bbox="457 718 1060 818">*The yellow tire pressure monitoring system warning lamp (pressure loss/malfunction) flashes for approximately one minute and then remains lit. The tire pressure monitoring system is malfunctioning.</p> <div data-bbox="464 835 1102 1082" style="border: 1px solid gray; padding: 5px;"> <p data-bbox="475 844 1044 896">▲ WARNING There is a risk of an accident if the tire pressure monitoring system is malfunctioning</p> <p data-bbox="481 906 1080 956">The tire pressure monitoring system cannot issue a warning if there is pressure loss in one or more of the tires.</p> <p data-bbox="481 965 1087 1016">Tires with insufficient tire pressure may impair the driving characteristics as well as steering and braking.</p> <p data-bbox="481 1023 1056 1075">► Have the tire pressure monitoring system checked at a qualified specialist workshop.</p> </div> <p data-bbox="464 1098 850 1121">► Consult a qualified specialist workshop.</p>
 <p data-bbox="185 1227 405 1304">Tire pressure monitoring system warning lamp lights up</p>	<p data-bbox="457 1139 1090 1240">*The yellow tire pressure monitoring system warning lamp (pressure loss/malfunction) lights up. The tire pressure monitoring system has detected a loss of pressure in at least one tire.</p> <div data-bbox="464 1256 1102 1530" style="border: 1px solid gray; padding: 5px;"> <p data-bbox="475 1265 1071 1288">▲ WARNING Risk of an accident due to insufficient tire pressure</p> <ul data-bbox="488 1300 1064 1417" style="list-style-type: none"> • The tires can burst. • The tires can wear excessively and/or unevenly. • The driving characteristics as well as the steering and braking may be greatly impaired. <p data-bbox="481 1433 854 1456">You could then lose control of the vehicle.</p> <p data-bbox="481 1465 892 1489">► Observe the recommended tire pressures.</p> <p data-bbox="481 1498 843 1521">► Adjust the tire pressure if necessary.</p> </div> <p data-bbox="464 1548 1012 1571">► Stop the vehicle in accordance with the traffic conditions.</p> <p data-bbox="464 1580 833 1603">► Check the tire pressure and the tires.</p>

- 1, 2, 3 ...**
- 3-zone automatic climate control (control panel)**..... 104
- 360° Camera**
- Care..... 222
 - Function..... 159
- A**
- A/C function**..... 105
- ABS**..... 144
- Accident and Breakdown Management**
- Mercedes me connect..... 187
- Activating/deactivating the acoustic locking verification signal**..... 50
- Active Brake Assist**
- Function..... 147
 - Setting..... 149
- Active Distance Assist DISTRONIC**
- Calling up a speed..... 153
 - Function..... 152
 - Increasing/decreasing speed..... 153
 - Requirements..... 153
 - Steering-wheel buttons..... 153
 - Storing a speed..... 153
 - Switching off/deactivating..... 153
 - Switching on/activating..... 153
- Active Lane Keeping Assist**
- Activating/deactivating..... 169
 - Function..... 168
 - Trailer operation..... 168
- Adaptive Highbeam Assist**
- Function..... 89
 - Switching on/off..... 89
- Adding fluid to the windshield washer system**..... 219
- Additional turn signal light**
- All-wheel-drive vehicle..... 94
- Additional turn signal light (all-wheel drive vehicles)**
- Replacing light bulbs..... 94
- Additive**
- DEF..... 134
- Additives**
- Additives (engine oil)..... 275
 - Additives (fuel)..... 272
 - Engine oil..... 275
 - Fuel..... 272
- Adjusting the lights (driving abroad)**..... 87
- ADR (working speed control)**
- Adjusting..... 169
 - Function..... 169
 - Switching on/off..... 169
- Air bag**
- Inflating..... 36
 - Overview..... 40
 - Warning lamp..... 35
- Air intake box**
- Cleaning the water drain valve..... 219
- Air vents**
- Adjusting (front)..... 107
 - Adjusting (rear passenger compartment)..... 108
 - Adjusting (roof)..... 107
- Air-recirculation mode**..... 106
- Alarm system**..... 65
- All-wheel drive**
- Notes..... 127
- Alternative route**..... 199
- Animals**..... 38
- Anti-lock braking system**..... 144
- Anti-skid chain**..... 239
- Anti-theft alarm system**
- Activating/deactivating..... 66
 - Activating/deactivating interior protection..... 67
 - Function..... 65
 - Interior motion sensor..... 67
 - Stopping the alarm..... 66
 - Switching the tow-away alarm on/off.... 66
 - Tow-away alarm..... 66
- Anti-theft protection**
- Immobilizer..... 65
- Apps, Mercedes me**..... 188
- Ashtray**..... 83
- ASR (acceleration skid control)**..... 145
- Assistance system**..... 144
- Assistant display (on-board computer)**..... 179
- ASSYST PLUS, After-sales service center, Service, Service interval display, Vehicle maintenance**
- Battery disconnection periods..... 214
 - Displaying the service due date..... 214
 - Function/notes..... 214
 - Regular maintenance work..... 214
 - Special service requirements..... 214
- Attachments**..... 22

- ATTENTION ASSIST**
 Function..... 162
 Setting..... 163
Attention assistant..... 162
Authorised workshop..... 26
Automatic climate control..... 105
Automatic distance control..... 152
Automatic driving lights..... 87
Automatic locking
 after closing the last door..... 53
Automatic measures after an accident..... 36
Automatic transmission
 DIRECT SELECT lever..... 125
 Engaging drive position..... 126
 Engaging neutral..... 125
 Engaging reverse gear..... 125
 Kickdown..... 127
 Restricting the shift range..... 126
 Selecting park position..... 126
 Transmission position display..... 125
 Transmission positions..... 125
Auxiliary heating, Stationary heating/ventilation
 Function..... 108
Axle load..... 269
- B**
- Back support, Lumbar support**..... 73
Backup lamp
 Replacing light bulbs (chassis)..... 96
BAS..... 145
Basic information..... 33
Battery
 Charging..... 230
 Charging the starter battery..... 230
 Key..... 50
 Notes (vehicle battery)..... 228
 Starting assistance..... 230
Battery main switch
 Notes..... 124
 Switching power supply on/off..... 124
Belt
 Adjusting the height..... 35
 Fastening..... 35
 Notes on wearing correctly..... 34
 Unfastening..... 40
Blind Spot Assist
 Activating/deactivating..... 166
 Function..... 165
 Rear Cross Traffic Alert..... 167
Bluetooth®
 Connecting a mobile phone..... 203
Bodies (body/equipment mounting directives)..... 22
Bottle holder..... 82
Brake
 ABS (anti-lock braking system)..... 144
 Activating/deactivating the HOLD function..... 155
 Active Brake Assist..... 147
 BAS (Brake Assist System)..... 145
 Braking with parking brake..... 116
 Breaking-in notes..... 113
 Downhill gradient..... 116
 Driving instructions..... 113, 116
 EBD (Electronic Brakeforce Distribution)..... 147
 Heavy/light loads..... 116
 HOLD function..... 155
 Limited braking effect (salt-treated roads)..... 116
 New brake disks/brake linings..... 116
 new brake linings/brake disks..... 113
 Post-collision brake..... 36
 Wet road surfaces..... 116
Brake Assist System..... 145
Brake fluid..... 277
Brakeforce Distribution..... 147
Braking assistance..... 145
Breakdown
 Assistance overview..... 18
 Changing a wheel..... 257
 Roadside Assistance..... 24
 Tow-starting..... 233
 Transporting the vehicle..... 232
Breaking-in notes..... 113
Bulbs..... 93
Buttons (steering wheel)..... 177
- C**
- Calls**
 Telephone menu..... 204
 Using overhead control panel..... 184
Camera
 Select view..... 162
Cameras
 360° Camera..... 159
 Rear-view camera..... 157
Car key..... 49























- Car wash (care)**..... 221
- Car-to-X-Communication**
 - Display on map..... 200
- Care**
 - Car wash..... 221
 - Exterior lighting..... 222
 - Power washer..... 221
 - Reversing camera/360° Camera..... 222
 - Sensors..... 222
 - Tailpipes..... 222
 - Trailer hitch..... 222
 - Washing by hand..... 222
 - Wheels/rims..... 222
 - Windows..... 222
 - Wiper blades..... 222
- Cargo compartment lamp (motion detector)**..... 92
- Cargo compartment ventilation**..... 109
- Cargo tie-down point**..... 283
- Cargo tie-down points**
 - Overview..... 211
- Cargo tie-down rings**
 - Loads..... 283
- Carpet**
 - Cleaning..... 224
- Central locking system**
 - Button..... 52
- Change of address**..... 24
- Change of ownership**..... 24
- Changing a wheel**
 - Installing a new wheel..... 260
 - Lowering the vehicle..... 261
 - Preparing..... 257
 - Raising the vehicle..... 257
 - Removing a wheel..... 260
- Changing bulbs**
 - High beam..... 93
 - Indicator (front)..... 93
 - Low beam..... 93
 - Tail lamp bulb types (chassis)..... 96
- Characteristics of the tire**..... 252
- Charging**
 - Battery..... 230
 - Charging wirelessly (mobile phone)..... 85
 - Charging wirelessly (mobile telephone in front)..... 85
 - Mobile telephone (USB socket)..... 84
- Child safety lock**
 - Sliding door..... 47
- Child seat**
 - Adjusting the vehicle seat..... 44
 - Basic instructions..... 41
 - Front passenger seat..... 43
 - Installing ISOFIX..... 45
 - Risks/dangers..... 42
 - Securing to the front passenger seat with the seat belt..... 47
 - The most important information in brief..... 41
 - Top Tether..... 46
- Children**
 - Avoiding dangers in the vehicle..... 42
 - Basic instructions..... 41
 - Special seat belt retractor..... 45
- Cigarette lighter**..... 83
- Clean varnish**..... 222
- Cleaning**
 - Paint..... 222
 - Vehicle interior..... 224
 - Washing by hand..... 222
- Cleaning the water drain valve (air intake box)**..... 219
- Climate control**
 - A/C function..... 105
 - Activating/deactivating..... 104
 - Adjusting air vents (roof)..... 107
 - Air distribution settings..... 105
 - Air vents (front)..... 107
 - Air vents (rear passenger compartment)..... 108
 - Air-recirculation mode..... 106
 - Automatic control (rear compartment)..... 105
 - Automatically regulating..... 105
 - Auxiliary heating..... 108
 - Cargo compartment ventilation (roof ventilator)..... 109
 - Clearing fogged up windows..... 106
 - Control panel for 3-zone automatic climate control..... 104
 - Control panel for dual-zone automatic climate control..... 103
 - Refrigerant..... 279
 - Setting the air distribution..... 106
 - Setting the rear compartment climate control..... 104
 - Switching the rear window heater on/off..... 107
 - Switching the windshield heater on/off..... 107
 - Synchronization function..... 106



























Co-driver bench seat	
Folding the seat surface forwards/ backwards.....	75
COC papers, CERTIFICATE OF CON- FORMITY.....	267
Cockpit	
Instrument panel.....	6
Coffee cup symbol.....	162
Combination switch	
Lights.....	88
Rear window wiper.....	98
Windshield wipers.....	97
Commuter route.....	199
Components relevant to radio regula- tion	
Declaration of conformity.....	25
Conversions.....	22
Coolant	
Capacity.....	278
Checking level.....	218
Copyright	
License.....	32
Copyrights	
Trademarks.....	32
Cornering light.....	89
Correct use.....	27
Cross traffic (warning).....	167
Crosswind Assist.....	146
Cruise control	
Activating/deactivating.....	150
Buttons.....	150
Calling up a speed.....	150
Function.....	149
Increasing/decreasing the speed.....	150
Requirements:.....	150
Selecting.....	150
Setting a speed.....	150
Storing a speed.....	150
Cup holders	
Center console.....	82
Rear passenger compartment.....	82
Customer Assistance Center (CAC).....	28
D	
Damage	
Limited protection.....	38
Data processing in the vehicle.....	29
Data protection rights.....	31
Data storage	
Data protection rights.....	31
Electronic control units.....	29
Event Data Recorder.....	31
Onboard Logic Unit.....	31
Online services.....	31
Dealership.....	26
Declaration of conformity	
Components relevant to radio regu- lation.....	25
DEF, Additives (DEF), Reducing agent	
Additive.....	134
Displaying the fill level.....	135
Purity.....	134
Refilling.....	135
DEF[®], Reducing agent	
Capacity.....	275
Notes.....	274
Definitions (tires and loading).....	253
Deployed components	
Limited protection.....	39
Deployment situations.....	36
Destination entry.....	198
Diagnostics connection.....	25
Dialing a phone number (on-board com- puter).....	182
Diesel	
Low outside temperatures.....	272
Notes.....	272
Diesel particulate filter	
Automatic regeneration.....	122
Displaying load.....	123
Starting/canceling regeneration.....	123
Digital inside rear view mirror.....	100
Digital Operator's Manual.....	20
Digital speedometer.....	180
DIRECT SELECT lever	
Engaging drive position.....	126
Engaging neutral.....	125
Engaging park position automatically... Engaging reverse gear.....	126
Function.....	125
Selecting park position.....	126
Transmission position display.....	125
Transmission positions.....	125
Display	
Cleaning.....	224
Display (instrument cluster).....	178

Display message, Message (instrument cluster)

- Calling up in the on-board computer.... 285
- Notes..... 285

Display messages

-  294
-  --- mph..... 291
-  Add 1 Liter Engine Oil When Next Refueling..... 295
-  Attention Assist Inoperative..... 294
-  Attention Assist: Take a Break!.. 294
-  AUTO Lamp Function Inoperative..... 304
-  Check Brake Fluid Level..... 288
-  Check Engine Oil At Next Refueling..... 296
-  Check Tires..... 298
-  Clean Fuel Filter..... 294
-  Coolant Stop Vehicle Switch Off Engine..... 297
-  Currently Unavailable Camera View Restricted..... 292
-  Currently Unavailable See Operator's Manual..... 290
-  Currently Unavailable See Operator's Manual..... 290
-  Don't Forget Your Key..... 299
-  Engine Oil Level Cannot Be Measured..... 295
-  Engine Oil Level Reduce Oil Level..... 295
-  Engine Oil Level Stop Vehicle Switch off Engine..... 295
-  Engine Oil Pressure Stop Vehicle Switch Off Engine..... 295
-  Front Left Malfunction Service Required (example)..... 286
-  Incline Too Steep See Operator's Manual..... 287
-  Inoperative Battery Low..... 301
-  Inoperative Refuel Vehicle..... 301
-  Inoperative See Operator's Manual..... 290

-  Inoperative See Operator's Manual..... 300
-  Inoperative See Operator's Manual..... 289
-  EBD Inoperative See Operator's Manual..... 289
-  Key Not Detected (red display message)..... 299
-  Key Not Detected (white display message)..... 299
-  Left Side Curtain Airbag Malfunction Service Required (example)... 286
-  Low Beam Left (example)..... 304
-  Malfunction See Operator's Manual..... 304
-  Obtain a New Key..... 300
-  Off..... 291
-  HOLD Off..... 292
-  Parking Brake Inoperative..... 287
-  Parking Brake See Operator's Manual..... 287
-  Place Key in Marked Space See Operator's Manual..... 299
-  Please Correct Tire Pressure..... 299
-  Refill Coolant See Operator's Manual..... 297
-  Refill Washer Fluid..... 300
-  Replace Air Filter..... 294
-  Replace Key Battery..... 300
-  Reserve Fuel..... 294
-  SRS Malfunction Service Required..... 286
-  Steering Malfunction Increased Physical Effort See Operator's Manual..... 301
-  Steering Malfunction Stop Immediately See Operator's Manual... 301
-  Step Not Extended See Operator's Manual or step not extended malfunction..... 303
-  Switch Off Lights..... 304
-  Switch On Headlamps..... 304

-  Veh. Tracking Activated See Op. Manual or mobile app..... 303
-  Warning Tire Malfunction..... 298
-  Wheel Sensor(s) Missing..... 298
- 120 km/h Maximum Speed Exceeded..... 294
- Active Brake Assist Functions Currently Limited See Operator's Manual..... 288
- Active Brake Assist Functions Limited See Operator's Manual..... 288
- Active Distance Assist Inoperative..... 291
- Active Distance Assist Now Available.. 291
- Active Lane Keeping Assist Camera View Restricted See Operator's Manual..... 293
- Active Lane Keeping Assist Currently Unavailable See Operator's Manual..... 294
- Active Lane Keeping Assist Inoperative..... 293
- Adaptive Highbeam Assist Camera View Restricted See Operator's Manual..... 303
- Adaptive Highbeam Assist Currently Unavailable See Operator's Manual.... 303
- Adaptive Highbeam Assist Inoperative..... 303
- Air Conditioning Malfunction See Operator's Manual..... 301
- Apply Brake to Shift from 'P'..... 302
- Auxiliary Battery Malfunction..... 302
- Blind Spot Assist Inoperative..... 293
- Blind Spot Assist Trailer Not Monitored..... 293
- Check Brake Pads See Operator's Manual..... 288
- CRUISE CONTROL Inoperative..... 291
- Currently Unavailable Radar Sensors Dirty..... 292
- Do Not Change Transmission Position Service Required..... 302
- Manual Regeneration Not Possible..... 297
- N Permanently Active Risk of Rolling Away..... 302
- Only Shift to 'P' when Vehicle is Stationary..... 302
- Radar Sensors Dirty See Operator's Manual..... 288
- Reversing Not Possible: Service Required..... 302
- Risk of Rolling Driver's Door Open and Transmission Not in P..... 302
- Risk of rolling, driver's seat not occupied and transmission not in P.... 300
- SOS NOT READY..... 289
- Tire Press. Monitor Currently Unavailable..... 298
- Tire Pressure Monitor Inoperative..... 299
- Tire Pressure Monitor Inoperative No Wheel Sensors..... 298
- To Engage Transmiss. Position R First Depress the Brake..... 301
- Traffic Sign Assist Camera View Restricted See Operator's Manual..... 292
- Traffic Sign Assist Currently Unavailable See Operator's Manual..... 293
- Traffic Sign Assist Inoperative..... 292
- Transmission Malfunction Stop..... 302
- Displaying range (trip menu)..... 180**
- Displaying the trip computer**
Trip menu (on-board computer)..... 180
- Displays (on-board computer)..... 178**
- Distance control..... 152**
- Distance warning..... 147**
- DISTRONIC..... 152**
- Door**
Activating/deactivating the automatic locking mechanism..... 53
- Locking/unlocking mechanical key..... 54
- Opening (from the inside)..... 51
- Unlocking (from the inside)..... 51
- Door control panel..... 16**
- DOT, Tire Identification Number (TIN)..... 251**
- Double co-driver's seat..... 75**
- Downhill driving assist, DSR**
Activating/deactivating DSR..... 151
- Notes..... 150

- Drinking and driving**..... 113
- Drive Away Assist**..... 166
- Driver profile**..... 193
- Driving in winter**..... 118
- Driving instructions**
- Brakes..... 116
 - Breaking-in notes..... 113
 - Downhill gradient..... 116
 - Drinking and driving..... 113
 - Driving abroad (information)..... 115
 - Driving in winter..... 118
 - General driving tips..... 113
 - Light adjustment when driving abroad... 87
 - Limit speed..... 115
 - Limited braking effect (salt-treated roads)..... 116
 - New brake disks/brake linings..... 116
 - Parking brake..... 116
 - Short-distance trips..... 115
 - Slippery road surfaces..... 118
 - Subjecting brakes to a load..... 116
 - Wet road surfaces (brake)..... 116
- Driving notes**
- Transport by rail..... 116
- Driving safety system**
- ABS (anti-lock braking system)..... 144
 - Active Brake Assist..... 147
 - ASR (acceleration skid control)..... 145
 - ATTENTION ASSIST..... 162
 - BAS (Brake Assist System)..... 145
 - Blind Spot Assist..... 165
 - Cruise control..... 149
 - EBD (Electronic Brakeforce Distribution)..... 147
 - ESP® (Electronic Stability Program).... 145
 - ESP® Crosswind Assist..... 146
 - ESP® trailer stabilization..... 146
 - Hill Start Assist..... 155
 - HOLD function..... 155
 - Lane Keeping Assist/Active Lane Keeping Assist..... 167
 - Overview..... 144
 - Radar sensors..... 144
 - Traffic Sign Assist..... 163
 - Your responsibility..... 143
- Driving system**..... 144
- Driving tips**
- Driving off-road..... 118
 - Driving on flooded roads..... 117
 - Driving on wet roads..... 117
 - Hydroplaning..... 117
 - Mountainous terrain..... 121
- Drowsiness detection**..... 162
- Drunk driving**..... 113
- DSR (Downhill Speed Regulation)**
- Activating/deactivating..... 151
 - Notes..... 150
- Dual-zone automatic climate control (control panel)**..... 103
- Dynamic handling control system**..... 145
- E**
- E10, Fuel (gasoline)**..... 271
- EBD, Electronic Brakeforce Distribution**.... 147
- EC general operating permit number**..... 269
- ECO display**
- Function..... 122
 - Resetting..... 181
- Electric closing aid (sliding door)**..... 55
- Electric parking brake**
- Automatically applying..... 141
 - Emergency braking..... 143
 - Manually applying/releasing..... 142
 - Notes..... 141
 - Releasing automatically..... 142
- Electric sliding door**
- Function..... 55
 - Open/close with button..... 56
 - open/close with key button..... 57
 - Opening with the door handle..... 57
 - Opening/closing (from the inside)..... 56
 - Resetting..... 59
 - Unlocking manually..... 58
- Electrical fuses**
- Notes..... 233
- Electrical step**
- Emergency release..... 63
 - Obstruction..... 62
 - Preventing extension..... 62
 - Retracting/extending..... 62
- Electronic Stability Program**
- Activating/deactivating..... 146
- Electronics**
- Engine electronics..... 267
 - Installing two-way radios..... 267
- Emergency**
- Assistance overview..... 18
 - First-aid kit (soft sided)..... 226
 - Safety vest..... 226
 - Warning lamp..... 226
- Emergency braking**
- Electric parking brake..... 143

- Manual parking brake..... 141
 - Emergency call system**
 - Automatic emergency call..... 227
 - Information..... 226
 - Manual emergency call..... 227
 - Overview..... 226
 - Transferred data..... 227
 - Emergency key**
 - Removing/inserting..... 50
 - Emergency operation mode**
 - Starting the vehicle..... 112
 - Emergency Tensioning Devices**
 - Inflating..... 36
 - Energy consumption**
 - SmartKey..... 50
 - Engaging drive position (automatic transmission)**..... 126
 - Engaging neutral (automatic transmission)**..... 125
 - Engaging reverse gear (automatic transmission)**..... 125
 - Engine**
 - Problems (fuel/fuel tank)..... 134
 - Starting assistance..... 230
 - Switching off (start/stop button)..... 139
 - Engine electronics**..... 267
 - Engine number**..... 269
 - Engine oil, Oil**
 - Additives..... 275
 - Capacity..... 275
 - Checking the oil level (on-board computer)..... 216
 - Topping up..... 217
 - Engine output**
 - Notes on changes..... 26
 - ENR (electronic level control)**
 - Function..... 128
 - Manually pumping up the air bellows... 131
 - Problems..... 132
 - Raising/lowering..... 129
 - Environmental protection**
 - Driving style..... 21
 - Environmentally friendly driving style**..... 21
 - ESC, Electronic Stability Control**..... 145
 - ESP®**
 - Activating/deactivating..... 146
 - Crosswind Assist..... 146
 - Function..... 145
 - Trailer stabilization..... 146
 - Event Data Recorder**..... 31
 - Exhaust emission monitoring**..... 115
 - Exhaust gas aftertreatment**..... 274
 - Exterior lighting**
 - Care..... 222
 - Replacing illuminants (front)..... 93
- ## F
- Factory settings**
 - MBUX reset function..... 195
 - Fastening**..... 35
 - First aid**
 - First-aid kit (soft sided)..... 226
 - First-aid kit (soft sided)**..... 226
 - Flat tire**
 - Changing a wheel..... 257
 - Tire-change tool kit..... 257
 - Floor mats**..... 86
 - Free software**..... 32
 - Frequencies**
 - Mobile phone..... 268
 - Two-way radios..... 268
 - Front air bag**
 - Inflating..... 36
 - Front seat**
 - 8-way adjustment options..... 71
 - Adjusting (electrically)..... 71
 - Adjusting manually..... 70
 - Manually adjusting..... 68
 - Memory function..... 71
 - Rotating..... 74
 - Fuel**
 - Diesel..... 272
 - Draining the filter..... 220
 - E10..... 271
 - Flexible-fuel vehicles..... 271
 - Gasoline..... 271
 - Low outside temperatures..... 272
 - Problems..... 134
 - Quality (diesel)..... 272
 - Quality (gasoline)..... 271
 - Refueling..... 132
 - Sulfur content..... 271
 - Tank content and fuel reserve..... 273
 - Use of additives..... 272
 - Fuel consumption (on-board computer)**.... 180
 - Fuel tank**
 - Problems..... 134
 - Function the event of an accident**..... 36

- Fuses**
 Fuse box (co-driver footwell)..... 234
 Fuse box (seat base of driver's seat).... 234
 Notes..... 233
- G**
- Gasoline**..... 271
General operating permit number (EC)..... 269
Genuine parts..... 21
Getting in/getting out..... 54
Grab handles
 Using..... 54
Gross axle weight rating..... 269
- H**
- Handbrake**..... 140
Handling characteristics
 Unusual..... 238
Hazard warning light system..... 88
Hazard warnings
 Car-to-X-Communication..... 200
Head restraint
 Manually adjusting..... 79
Headlamp flashing..... 88
Heating system..... 102
High beam
 Activating/deactivating..... 88
 Adaptive Highbeam Assist..... 89
 Changing bulbs..... 93
Hill Start Assist..... 155
HOLD function
 Notes..... 155
 Switching on/off..... 155
Home screen
 Media display..... 191
Hotspot
 Setting up..... 194
Hydroplaning..... 117
- I**
- Identification plate**..... 269
Immobilizer..... 65
Inattention detection..... 162
Incorrect behavior by vehicle occupants
 Limited protection..... 37
Indicator
 Changing bulbs (front)..... 93
- Inside rear view mirror**
 Digital inside rear view mirror..... 100
- Inside rearview mirror**
 Adjusting/setting anti-glare mode..... 101
- Installation of accessories**
 Limited protection..... 38
- Installations**..... 22
- Instrument cluster, Instrument display**
 Adjusting the lighting..... 179
 Function/notes..... 176
 Information on the display..... 178
 Overview..... 8, 176
- Instrument lighting, Dashboard lighting**..... 179
- Instrument panel**
 Cockpit..... 6
- Intelligent light system**
 Adaptive Highbeam Assist..... 89
 Cornering light..... 89
- Interior lamp**
 Replacing illuminants (rear passenger compartment)..... 97
- Interior lighting**
 Box bodies..... 90
 Cargo compartment..... 92
 Equipment (bus)..... 91
 Motion detector (rear passenger compartment)..... 92
 Reading light (passenger seat)..... 92
 Rear compartment..... 92
 Setting..... 90
 Switch-off delay time..... 93
- Interior motion sensor**
 Activating/deactivating..... 67
 Function..... 67
- Internet**
 Setting up a Wi-Fi hotspot..... 194
 Web browser..... 204
- ISOFIX child seat anchor**
 Installing..... 45
- J**
- Jack**
 Hydraulic..... 236
 Removing from stowage compartment (hydraulic jack)..... 236
 Storage location..... 257
 Storage location (hydraulic jack)..... 236
- Journeys abroad**
 Light adjustment low beam..... 87
 Notes..... 115

Jump-start connection, Starting assistance..... 230

K

Key

Battery..... 50
 Central locking system..... 50
 electric sliding door open/close..... 57
 Emergency key..... 50
 Fastening to keyring..... 50
 Functions..... 49
 Problem..... 51
 Radio connection..... 49
 Unlocking setting..... 50

L

Lamp..... 93

Lane Keeping Assist

Function..... 167
 System limits..... 167
 Trailer operation..... 167

Lane recognition..... 168

Language

Notes..... 195
 Setting..... 195

Level regulation..... 128

License plate lamp

Replacing light bulbs..... 96

Light switch (overview)..... 87

Lights, Lighting

Activating/deactivating the surround lighting..... 90
 Adaptive Highbeam Assist..... 89
 Adjusting the instrument lighting..... 179
 Automatic driving lights..... 87
 Combination switch..... 88
 Cornering light..... 89
 Hazard warning lights..... 88
 Headlamp flashing..... 88
 High beam..... 88
 Light adjustment when driving abroad... 87
 Light switch..... 87
 Low beam..... 87
 Parking light..... 87
 Rear fog light..... 87
 Responsibility with lighting systems..... 87
 Switch-off delay time..... 90
 Turn signal light..... 88

Limit speed

Notes..... 115

Limited Warranty..... 29

Live Traffic Information..... 200

Load

Determining the maximum..... 248
 Sample calculation..... 248

Load distribution..... 210

Load securing

Cargo tie-down points..... 211
 Notes..... 210

Load-bearing capacity (tires)..... 252

Loading

Definitions..... 253

Loading guidelines..... 209

Loading information table..... 247

Locking/unlocking

Activating/deactivating the automatic locking mechanism..... 53
 Doors (interior)..... 51
 Mechanical key..... 54

Low beam

Activating/deactivating..... 87
 Changing bulbs..... 93
 Light adjustment when driving abroad... 87

Lubricants

Additives (engine oil)..... 275
 Notes on operating fluids..... 270

Lumbar support (4-way)..... 73

M

M+S tires..... 239

Maintenance

Carpet..... 224
 Display..... 224
 Paint..... 222
 Plastic trim..... 224
 Real wood/trim elements..... 224
 Roof lining..... 224
 Seat belt..... 224
 Seat cover..... 224
 Vehicle..... 24

Malfunction

Restraint system..... 35

Malfunction message

Notes on display messages..... 285

Maneuvering assistance

Activating/deactivating..... 162

Manual parking brake

Applying/releasing..... 140
 Emergency braking..... 141
 Folding up/down..... 141

- Manually pumping up the air bellows (electronic level control)**..... 131
- Map**
 - Displaying online map contents..... 200
 - Displaying weather information..... 200
 - Moving..... 199
 - Parking service..... 200
 - Selecting the map orientation..... 199
 - Setting the map scale..... 199
 - Switching freeway information on/off..... 199
- Map functions**..... 199
- Maximum gross vehicle weight**..... 269
- Maximum load**
 - Determining..... 248
 - Sample calculation..... 248
- Maximum tire load**..... 251
- Maximum tire pressure**..... 252
- MBUX**..... 191
- MBUX display**
 - Home screen..... 191
- MBUX multimedia system**
 - Factory setting..... 195
 - Media..... 205
 - Mercedes me & Apps..... 188
 - Notes..... 190
 - Overview..... 190
 - Profile..... 193
 - Touchscreen..... 191
- Mechanical key**
 - Locking/unlocking the door..... 54
- Media**
 - Menu (on-board computer)..... 182
 - Operating media playback (on-board computer)..... 182
 - Overview of functions/symbols..... 205
 - Selecting a media source (on-board computer)..... 182
- Media display**
 - Home screen..... 191
 - Operating..... 191
- Media mode**
 - Connecting Bluetooth® audio equipment..... 206
- Medical aids**..... 28
- Memory function**
 - Outside mirrors..... 73
 - Seat..... 73
- Menu (on-board computer)**
 - Assistance graphic..... 179
 - Media..... 182
 - Navigation..... 181
 - Overview..... 177
 - Radio..... 182
 - Service..... 179
 - Settings..... 183
 - Telephone..... 182
 - Trip..... 180
- Mercedes me app**
 - Calling up services..... 189
 - Calling up your user account..... 188
 - Unlinking the user account..... 189
- Mercedes me Apps**..... 188
- Mercedes me calls**
 - Arranging a service appointment..... 185
 - Calling the Mercedes-Benz customer center..... 184
 - Calling the Mercedes-Benz customer center after automatic accident or breakdown detection..... 185
 - Consenting to the transfer of data..... 186
 - Information on call using overhead control panel..... 184
 - Making a call via the overhead control panel..... 184
 - Transferred data..... 186
- Mercedes me connect**
 - Accident and Breakdown Management..... 187
 - Information..... 187
 - Making a call via the overhead control panel..... 184
 - Transferred data..... 188
- Message memory**..... 285
- Mirror**
 - Adjusting/setting anti-glare mode (inside rearview mirror)..... 101
 - Adjusting/setting anti-glare mode (outside mirrors)..... 99
- Mirrors**
 - Digital inside rear view mirror..... 100
- Mobile phone**
 - Charging (USB socket)..... 84
 - Frequencies..... 268
 - Maximum transmission output..... 268
 - Wireless charging (front)..... 85
- Modification**
 - Limited protection..... 38
- Motion detector (cargo compartment)**..... 92
- Mounting a load**..... 209
- Multi Purpose Vehicle (MPV)**..... 27

- Multifunction steering wheel**
 Overview of buttons..... 177
- Multimedia system**..... 191
- N**
- Navigation**
 Activating..... 196
 Destination entry..... 198
 Displaying/hiding the menu..... 196
 Menu (on-board computer)..... 181
 Overview..... 197
- Navigation instructions (on-board computer)**..... 181
- Nominal tensile load of cargo tie-down rings**..... 283
- O**
- Objects in the vehicle interior**
 Limited protection..... 38
- Occupant safety**
 Air bag..... 40
 Automatic measures after an accident.. 36
 Basic information..... 33
 Child seat..... 41
 Information on the child restraint system..... 35
 Information on the correct seat position..... 33
 Pets in the vehicle..... 38
- On-board computer, Computer**
 Assistant display menu..... 179
 Diesel particulate filter load display.... 123
 Display..... 178
 Displaying the service due date..... 214
 Media menu..... 182
 Menu navigation..... 181
 Menu overview..... 177
 Operating..... 177
 Radio menu..... 182
 Service menu..... 179
 Settings menu..... 183
 Telephone menu..... 182
 Trip menu..... 180
- On-board diagnostic interface**..... 25
- On-board electronics**
 Engine electronics..... 267
 Installing two-way radios..... 267
- Onboard Logic Unit**
 Data storage..... 31
 Online services..... 31
- Online services**..... 31
- Open-source software**..... 32
- Opening/closing the hood**..... 214
- Operating fluids**
 Additives (fuel)..... 272
 Brake fluid..... 277
 DEF®..... 274
 Diesel..... 272
 Engine oil..... 275
 Gasoline..... 271
 Notes..... 270
 Notes on coolant (engine)..... 277
 Refrigerant (air conditioning system)... 279
 Windshield cleaning agent..... 278
- Operating safety**
 Changes in the engine output..... 26
 Information..... 24
- Operating system**
 On-board computer..... 177
- Operator's Manual**..... 23
- Operator's Manual digital**..... 20
- Outside mirrors**
 Adjusting/setting anti-glare mode..... 99
 Blind Spot Assist..... 165
 Folding in/out..... 99
 Memory function..... 73
 Setting options..... 16
- Overhead control panel**
 Adjusting the interior lighting..... 90
 Overview..... 11
- P**
- Paint code**..... 269
- Park position**
 Engaging..... 126
 Engaging automatically..... 126
- Parking aid**
 Parking Assist PARKTRONIC..... 156
- Parking Assist PARKTRONIC**
 Activating/deactivating..... 156
 Adjusting warning tones..... 157
 Drive Away Assist..... 166
 Function..... 156
 System limits..... 156
- Parking assistance systems**
 Parking Assist PARKTRONIC..... 156
- Parking brake (manual)**..... 140
- Parking brake lever**..... 140
- Parking for an extended period**..... 143
- Parking light**..... 87

- Parking service**..... 200
- Partition sliding door**
Opening/closing..... 61
- Permissible gross mass**..... 269
- Permissible towing methods**..... 231
- Pets in the vehicle**..... 38
- Placing a load on the wheel arch**..... 212
- Plastic trim (care)**..... 224
- Post-collision brake**..... 36
- Power supply**
Battery main switch..... 124
Switching on (start/stop button)..... 110
- Power washer (care)**..... 221
- Profile**
Creating a new profile..... 193
Information..... 193
Selecting profile options..... 193
- Protection**
Limited..... 37
- Pulling away**..... 155
- Q**
- QR code rescue card**..... 29
- Qualified specialist workshop**..... 26
- R**
- Radar sensors**
Care..... 222
Notes..... 144
- Radio**
Menu (on-board computer)..... 182
- Radio connection**
Key..... 49
- Radio regulations**
Regulatory radio identification..... 268
- Real wood (care)**..... 224
- Rear compartment climate control**
Automatic control..... 105
Setting..... 104
- Rear compartment lighting (motion detector)**..... 92
- Rear Cross Traffic Alert, Cross traffic warning**..... 167
- Rear fog light**..... 87
- Rear view camera**
Switching automatic mode on/off (surround view camera)..... 162
- Rear window wiper**
Switching on/off..... 98
- Rear-end doors**
open over 90°..... 60
Opening/closing (from the inside)..... 61
Opening/closing (from the outside)..... 59
- Rear-view camera**
Function..... 157
- Refilling**
Displaying the DEF level..... 135
- Refrigerant (air conditioning system)**..... 279
- Refueling**
Refilling DEF..... 135
Refueling the vehicle..... 132
- Regeneration**
Notes..... 122
Starting/canceling..... 123
- Registration**..... 27
- Regulatory radio information**
Specific absorption rate..... 268
- Remote Online**
Cooling/heating the vehicle interior.... 111
Starting the vehicle..... 112
- Replacement key, Spare key**..... 51
- Replacing**
Fuses..... 233
- Replacing light bulbs**
Additional turn signal light (all-wheel drive vehicles)..... 94
Backup lamp (chassis)..... 96
Interior lamp (rear passenger compartment)..... 97
License plate lamp..... 96
Light sources (front)..... 93
Notes..... 93
Rear turn signal lights (Cargo Van/ Passenger Van)..... 95
Reversing lamps (Cargo Van/ Passenger Van)..... 95
Tail lamp illuminant types (Cargo Van / Passenger Van)..... 94
Turn signal lights (chassis, rear)..... 96
- Reporting safety defects**..... 28
- Rescue card, QR code**..... 29
- Resetting**
MBUX reset function..... 195
- Responsibility**
Driving safety systems..... 143
- Restraint system**
Basic information..... 33

- Basic instructions for children..... 41
 - Deployment situations..... 36
 - Functionality..... 35
 - Information on function..... 36
 - Information on the correct seat position..... 33
 - Limited protection..... 38
 - Malfunction..... 35
 - Protection..... 33
 - Self-test..... 35
 - Warning lamp..... 35
 - Restricting the shift range**..... 126
 - Reverse gear**
 - Deactivating/activating the warning tone..... 121
 - Reverse warning device**..... 121
 - Reversing camera**
 - Care..... 222
 - Reversing lamps**
 - Replacing illuminants (Cargo Van/ Passenger Van)..... 95
 - Roadside Assistance (breakdown)**..... 24
 - Roll-away prevention**..... 155
 - Roof lining (care)**..... 224
 - Roof load**..... 284
 - Roof luggage rack, Carrier system**
 - Loads..... 284
 - Securing..... 212
 - Roof ventilator**
 - Activating/deactivating cargo compartment ventilation..... 109
 - Route**
 - Alternative route..... 199
 - Calculating..... 199
 - Commuter route..... 199
 - Navigation..... 197
 - Selecting options..... 199
- S**
- Safety system**..... 144
 - Safety vest**..... 226
 - Seat, Driver's seat**
 - 4-way lumbar support..... 73
 - 8-way adjustment options..... 71
 - Adjusting electrically (front)..... 71
 - Adjusting manually (front)..... 68, 70
 - Adjusting the head restraint manually.... 79
 - Adjusting the seat backrests (rear bench seat)..... 78
 - Adjusting the seat surface (co-driver bench seat)..... 75
 - Correct driver's seat position..... 68
 - Door control panel..... 16
 - Folding the folding seat up/down..... 75
 - Installing/removing rear bench seat..... 75
 - Memory function..... 71, 73
 - Rotating (front seat)..... 74
 - Side impact air bag..... 40
 - Switching seat heating on/off..... 79
 - Seat belt**
 - Adjusting the height..... 35
 - Cleaning..... 224
 - Fastening..... 35
 - Notes on wearing correctly..... 34
 - Unfastening..... 40
 - Warning lamp..... 35
 - Seat belt warning**..... 35
 - Seat cover (care)**..... 224
 - Seats, Rear bench seat**..... 75
 - Securing loads**
 - Cargo tie-down rings..... 211
 - Securing luggage**..... 209
 - Selector lever**..... 125
 - Self-test**
 - Restraint system..... 35
 - Sensors**..... 144
 - Sensors (care)**..... 222
 - Service (on-board computer)**..... 179
 - Service center**..... 26
 - Setting the air distribution**..... 106
 - Settings (on-board computer)**..... 183
 - Short-distance trips**..... 115
 - Side windows**
 - Opening/closing..... 63
 - Problem..... 65
 - Resetting..... 65
 - Size designation (tires)**..... 252
 - Sliding door**
 - Child safety lock..... 47
 - electric sliding door..... 55
 - electrical closing aid..... 55
 - Function..... 55
 - Open/close with button..... 56
 - Opening/closing (from the inside)..... 55
 - opening/closing (from the outside)..... 55
 - Slippery road surfaces**..... 118
 - SmartKey**
 - Acoustic locking verification signal..... 50

- Deactivating the function..... 50
 - Energy consumption..... 50
 - Smartphone Integration, iPhone®**
 - Android Auto..... 204
 - Apple CarPlay®..... 204
 - Snow chains**..... 239
 - Socket**
 - Trailer hitch..... 172
 - Socket (12 V)**
 - Center console (front)..... 83
 - Socket (115 V)**
 - Front center console..... 84
 - Notes..... 83
 - Software update**..... 194
 - SOS button**..... 184
 - Sound**
 - Menu..... 208
 - Sound settings**..... 208
 - Spare parts**..... 21
 - Spare wheel**
 - Installing/removing..... 263
 - Notes..... 262
 - Special seat belt retractor**..... 45
 - Specialist workshop**..... 26
 - Specific absorption rate (SAR)**..... 268
 - Speed control**
 - Active Distance Assist DISTRONIC..... 152
 - Cruise control..... 149
 - Speed rating (tires)**..... 252
 - Speedometer (digital)**..... 180
 - Start-off assist**..... 155
 - Start/stop button**
 - Parking the vehicle..... 139
 - Starting the vehicle..... 111
 - Switching on the power supply or the vehicle..... 110
 - Starting**
 - Remote Online..... 112
 - Starting the engine**
 - Remote Online..... 112
 - Starting-off aid**..... 155
 - Steering wheel**
 - Adjusting..... 80
 - Buttons..... 177
 - Driver's air bag..... 40
 - Step (electrical)**..... 62
 - Stopping the alarm**..... 66
 - Stowage areas**..... 81
 - Stowage compartment (vehicle tool kit)**..... 235
 - Stowage space**
 - Armrest..... 81
 - Bottle holder..... 82
 - Center console..... 81
 - Door..... 81
 - Glove box..... 81
 - Substances hazardous to health**..... 24
 - Sulfur content, Fuel (gasoline)**..... 271
 - Summer tires**..... 238
 - Surround lighting**..... 90
 - Surround view camera**
 - Switching automatic mode on/off (rear view camera)..... 162
 - Switch-off delay time**
 - Exterior..... 90
 - Interior..... 93
 - Switching on the vehicle (start/stop button)**..... 110
 - Switching seat heating on/off**..... 79
 - Switching the rear window heater on/off**... 107
 - Switching the windshield heater on/off**.... 107
 - Synchronization function**..... 106
 - System settings**
 - MBUX reset function..... 195
 - Overview..... 193
- T**
- Tailpipes (care)**..... 222
 - Tank content**
 - DEF®..... 275
 - Fuel..... 273
 - Reserve..... 273
 - Technical data**
 - Coolant filling capacity..... 278
 - Engine oil filling capacity..... 275
 - Information..... 267
 - Notes on trailer hitch..... 279
 - Radio regulations..... 268
 - Specific absorption rate (SAR)..... 268
 - Tank content and fuel reserve..... 273
 - Tire pressure monitoring system..... 247
 - Vehicle dimensions..... 279
 - Vehicle identification plate..... 269
 - Technical data®**
 - DEF filling quantity..... 275
 - Telephone, Smartphone**
 - Bluetooth® telephony..... 203

- Charging wirelessly (mobile telephone in front)..... 85
- Connecting a mobile phone..... 203
- Menu..... 204
- Menu (on-board computer)..... 182
- Notes..... 201
- Operating modes..... 203
- Secure Simple Pairing..... 203
- Telephone menu overview..... 203
- Temperature**
 - Setting centrally..... 106
- Tire and Loading Information placard**..... 247
- Tire Identification Number (TIN)**..... 251
- Tire information table**..... 247
- Tire labeling, Labeling (tires)**
 - Characteristics..... 252
 - DOT, Tire Identification Number (TIN).. 251
 - Load-bearing capacity..... 252
 - Maximum tire load..... 251
 - Maximum tire pressure..... 252
 - Overview..... 250
 - Size designation..... 252
 - Speed rating..... 252
 - Temperature grade..... 250
 - Tire quality grades..... 250
 - Tread wear grade..... 250
- Tire load (maximum)**..... 251
- Tire pressure**
 - Checking manually..... 246
 - Maximum..... 252
 - Notes..... 240
 - Restarting the tire pressure monitoring system..... 246
 - Tire pressure monitoring system..... 244, 246
 - Tire pressure table..... 241, 244
- Tire pressure monitoring system**
 - Checking the air pressure..... 246
 - Checking the temperature..... 246
 - Function..... 244
 - Restarting..... 246
 - Technical data..... 247
- Tire pressure table**..... 241, 244
- Tire temperature**
 - Checking..... 246
 - Tire pressure monitoring system..... 244
- Tire tread**..... 238
- Tire-change tool kit**..... 257
- Tires**
 - Characteristics..... 252
 - Checking..... 238
 - Checking the temperature..... 246
 - Definitions..... 253
 - Direction of rotation..... 256
 - DOT, Tire Identification Number (TIN).. 251
 - Installing..... 260
 - Load-bearing capacity..... 252
 - M+S tires..... 239
 - Maximum tire load..... 251
 - Maximum tire pressure..... 252
 - Mounting..... 255
 - Noise..... 238
 - Overview of tire labeling..... 250
 - Removing..... 260
 - Replacing..... 255, 257
 - Restarting the tire pressure monitoring system..... 246
 - Selection..... 255
 - Size designation..... 252
 - Snow chains..... 239
 - Speed rating..... 252
 - Storing..... 257
 - Summer tires..... 238
 - Tire and Loading Information placard.. 247
 - Tire pressure monitoring system..... 244
 - Tire pressure table..... 241, 244
 - Tire quality grades..... 250
 - Unusual handling characteristics..... 238
- Top Tether**..... 46
- Total distance, Odometer**
 - Displaying..... 180
- Touch Control**
 - MBUX..... 191
 - On-board computer..... 177
- Touchscreen**..... 191
- Tow-away alarm**
 - Activating/deactivating..... 66
 - Function..... 66
- Tow-starting**..... 233
- Towing eye**
 - Installing/removing..... 233
 - Storage location..... 233
- Towing methods**..... 231
- Traffic information**..... 200
- Traffic Sign Assist**
 - Function..... 163
 - Setting..... 165
- Trailer hitch**
 - Care..... 222
 - Coupling/uncoupling a trailer..... 172
 - Information..... 173
 - Information about trailer operation..... 170

- Notes..... 279
 - Permissible trailer loads and trailer drawbar noseweights..... 174
 - Power supply..... 175
 - Socket..... 172
 - Trailer loads**..... 280
 - Trailer operation**
 - Active Lane Keeping Assist..... 168
 - Coupling/uncoupling a trailer..... 172
 - Information..... 173
 - Lane Keeping Assist..... 167
 - Notes..... 170
 - Permissible trailer loads and trailer drawbar noseweights..... 174
 - Power supply..... 175
 - Socket..... 172
 - Trailer loads..... 280
 - Trailer stabilization**..... 146
 - Transmission position display**..... 125
 - Transport (vehicle)**..... 232
 - Transport by rail**..... 116
 - Trim element (care)**..... 224
 - Trip**
 - Displaying total distance..... 180
 - Menu (on-board computer)..... 180
 - Trip computer**
 - Resetting..... 181
 - Trip distance, Trip odometer**
 - Displaying..... 180
 - Resetting..... 181
 - Turn signal light**
 - Replacing illuminants (additional turn signal light, all-wheel-drive vehicle)..... 94
 - Replacing light bulbs (chassis, rear)..... 96
 - Turn signal lights**
 - Replacing illuminants (Cargo Van/ Passenger Van, rear)..... 95
 - Two-way radios**
 - Frequencies..... 268
 - Installation..... 267
 - Maximum transmission output..... 268
- U**
- Unfastening**..... 40
 - Unlocking setting**..... 50
 - Updates**..... 194
 - USB socket (front)**..... 84
 - Using kickdown, Acceleration**..... 127
 - Using the chock**..... 143
- V**
- Vehicle**
 - Activating, Remote Online..... 112
 - Activating/deactivating the automatic locking mechanism..... 53
 - Correct use..... 27
 - Data storage..... 29
 - Diagnostics connection..... 25
 - Equipment..... 23
 - Identification plate..... 269
 - Limited Warranty..... 29
 - loading..... 232
 - lock automatically..... 53
 - Locking/unlocking (from the inside)..... 52
 - Locking/unlocking mechanical key..... 54
 - Lowering..... 261
 - Maintenance..... 24
 - Medical aids..... 28
 - Parking for an extended period..... 143
 - Problem notification..... 28
 - QR code rescue card..... 29
 - Raising..... 257
 - Registration..... 27
 - Starting (emergency operation mode)..... 112
 - Starting (start/stop button)..... 111
 - Switching off (start/stop button)..... 139
 - Switching on the power supply (start/stop button)..... 110
 - Vehicle data**
 - Vehicle height..... 279
 - Vehicle length..... 279
 - Vehicle width..... 279
 - Wheelbase..... 279
 - Vehicle equipment**..... 23
 - Vehicle identification number**..... 269
 - Vehicle identification plate**..... 269
 - Vehicle interior**
 - Cooling/heating (Remote Online)..... 111
 - Vehicle key**..... 49
 - Vehicle level**
 - ENR (electronic level control)..... 128
 - Raising/lowering..... 129
 - Vehicle operation**
 - Outside the USA or Canada..... 23
 - Vehicle sensors**..... 144
 - Vehicle start**
 - Remote Online..... 112

Vehicle tool kit, Tool

- Removing..... 235
- Stowage compartment..... 235
- Towing eye..... 233

Vents..... 107

VIN..... 269

Voice Control System

- Operable functions..... 192
- Starting..... 193

















W

Warning lamp..... 226

Warning system..... 65

Warning tone, reverse gear..... 121

Warning/indicator lamp

-  ABS warning lamp..... 310
-  and..... 305, 306, 307, 308, 309
-  Brake system warning lamp (yellow)..... 307
-  Brake warning lamp (red) (Canada)..... 308
-  Brake warning lamp (red) (USA)..... 308, 309
-  Coolant warning lamp..... 312
-  Electric parking brake applied red indicator lamp (Canada) does not light up..... 305
-  Electric parking brake applied red indicator lamp (USA) does not light up..... 305
-  Electric parking brake malfunctioning yellow indicator lamp lights up..... 305, 306
-  Electric power steering warning lamp (red)..... 311
-  Electrical malfunction warning lamp..... 312
-  Engine diagnosis warning lamp..... 313
-  ESP® OFF warning lamp..... 310
-  ESP® warning lamp flashes..... 310
-  ESP® warning lamp lights up.... 309
-  Fuel reserve warning lamp..... 313

 Red electric parking brake applied indicator lamp (Canada) flashes..... 306

 Red electric parking brake applied indicator lamp (Canada) lights up..... 306, 307

 Red electric parking brake applied indicator lamp (USA) flashes... 306

 Red electric parking brake applied indicator lamp (USA) lights up..... 306, 307

 Red parking brake applied indicator lamp (Canada) lights up..... 307

 Red parking brake applied indicator lamp (USA) lights up..... 307

 Restraint system warning lamp..... 309

 Seat belt warning lamp flashes..... 311

 Seat belt warning lamp lights up..... 311

 The electric parking brake malfunctioning yellow indicator lamp does not light up..... 307

 Tire pressure monitoring system warning lamp flashes..... 313

 Tire pressure monitoring system warning lamp lights up..... 313

 Warning lamp for distance warning function..... 311

Warning/indicator lamps

Overview..... 8, 304

Warranty terms and conditions..... 23

Washer fluid..... 278

Washing by hand..... 222

Wear

Limited protection..... 38

Weather information..... 200

Web browser..... 204

WET WIPER SYSTEM..... 98

Wheel rotation..... 256

Wheel wrench..... 257

Wheels

Care..... 222

- Changing..... 256
- Characteristics of the tire..... 252
- Checking..... 238
- Checking the air pressure..... 246
- Checking the temperature..... 246
- Definitions..... 253
- DOT, Tire Identification Number (TIN).. 251
- Flat tire..... 228
- Installing..... 260
- Load-bearing capacity..... 252
- Maximum tire load..... 251
- Maximum tire pressure..... 252
- Mounting..... 255
- Noise..... 238
- Overview of tire labeling..... 250
- Removing..... 260
- Replacing..... 255, 257
- Restarting the tire pressure monitoring system..... 246
- Selection..... 255
- Size designation..... 252
- Snow chains..... 239
- Speed rating..... 252
- Storing..... 257
- Tire and Loading Information placard.. 247
- Tire pressure..... 240
- Tire pressure monitoring system..... 244
- Tire pressure table..... 241, 244
- Tire quality grades..... 250
- Tread wear grade..... 250
- Unusual handling characteristics..... 238
- Wheels (care)**..... 222
- Wi-Fi**
 - Setting up a hotspot..... 194
- Window curtain air bag**..... 40
- Windows**
 - Opening/closing..... 63
- Windows (care)**..... 222
- Windshield**
 - Replacing the wiper blades..... 98
- Windshield cleaning agent**..... 278
- Windshield wiper**
 - Replacing wiper blades (rear window).... 99
 - Switching on/off (rear window)..... 98
- Windshield wipers**
 - Replacing the wiper blades..... 98
 - Replacing the wiper blades (WET WIPER SYSTEM)..... 98
 - Replacing the wiper blades (windshield)..... 98
 - Switching on/off..... 97
 - Switching on/off (windshield)..... 97
- Winter operation**..... 239
- Winter tires**
 - Notes..... 239
- Wiper blades**
 - Care..... 222
 - Replacing (rear window)..... 99
 - Replacing (WET WIPER SYSTEM)..... 98
 - Replacing (windshield)..... 98
- Wireless charging**
 - Mobile telephone (front)..... 85
 - Notes..... 85
- Workshop**..... 26

